

# RADIO NEWS

APRIL  
25 CENTS

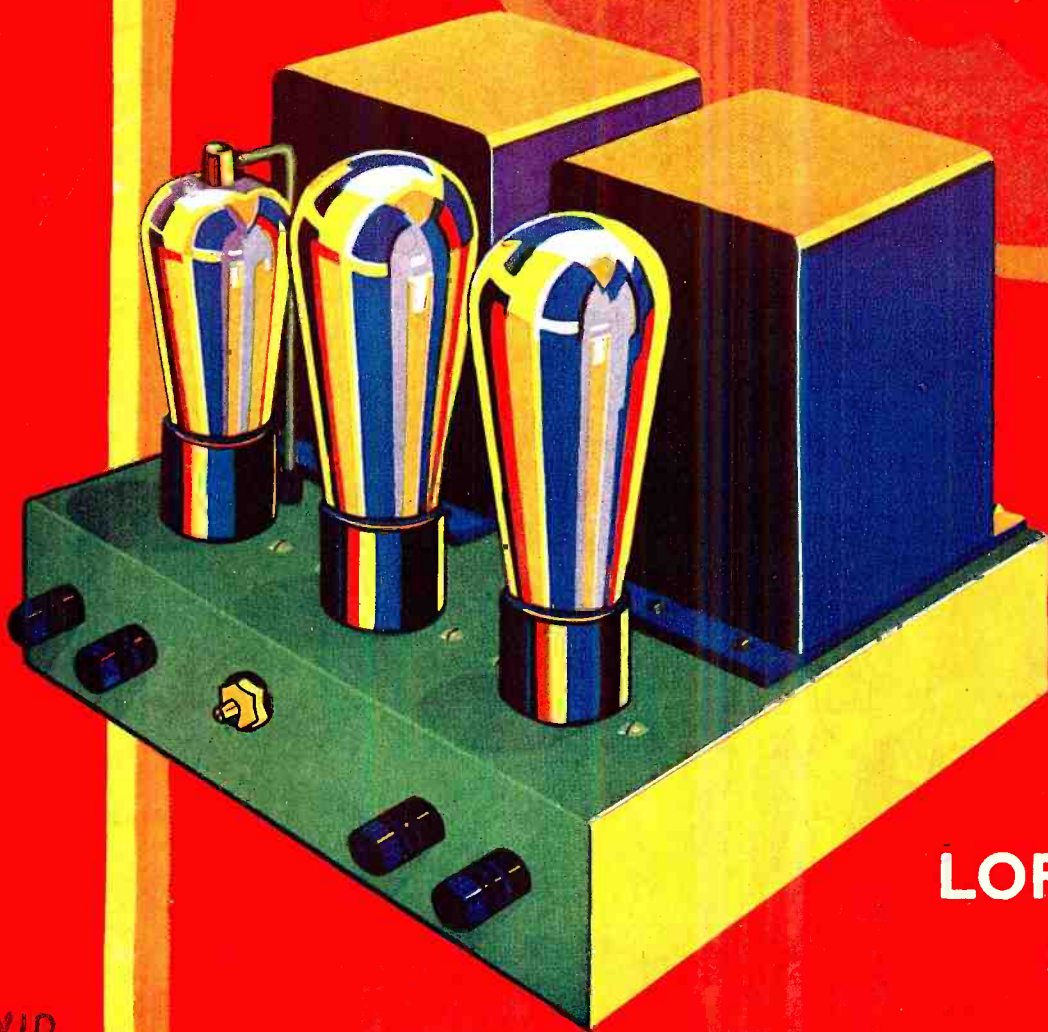

THE  
LOFTIN-WHITE  
SYSTEM

SEE PAGE 890

DAVID  
LYMES



# ADVANCED DESIGN AND PRECISION ENGINEERING

## keep the demand for Scott Receivers

and for the amazing new

# SCOTT RADIO CONTROL

far ahead of the capacity  
of the Scott Laboratory

The Cortez is one of the many magnificent models in the Scott line of Custom Built Radio. It is authentically Spanish, made of precious woods, hand-tooled leathers, with artfully done, genuine, hand-wrought iron trim. The price complete is \$705. Other models as low as \$263.50.

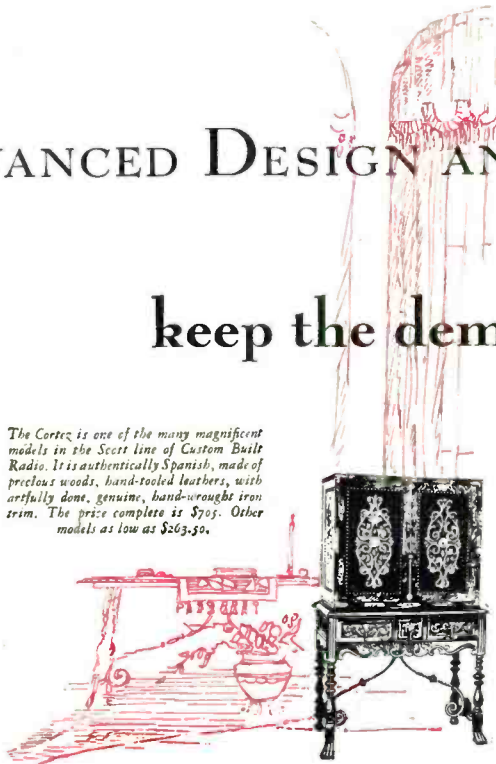

The chassis of the Scott A-C Shield Grid is a jewel of engineering precision. Four screen grid tubes are used. The overall amplification obtained is far greater than that obtained in any other receiver we know of.



Bare-nerve sensitivity! Seemingly unlimited power! Ability to bring in the greatest number of distant stations! Superb, perfectly realistic tone! Positive selectivity! Absolute dependability! These are the attributes of the new Scott World's Record A-C Shield Grid 10. Advanced design made them possible. Precision engineering makes them a reality!

Every Scott Receiver is laboratory made, by hand. The physical and electrical characteristics of every part and piece of wire in each individual receiver are determined one by one—not to a tolerance—but to exactness. Think of it! Advanced design carried out to precision standards! No wonder Scott Radio is the one and only World Record Radio—no wonder the demand for the Scott World's Record A-C Shield Grid 10 is greater than our capacity to produce them.

Touch a button  
... there's your station!

This newest product of Scott advanced design and precision engineering is the first practical application of the idea of remote control. It is more than practical; it is perfected! Touch a button—there's the station of your choice—control the volume by turning a tiny knob—that's all there is to it. The actual tuning is done in the Control itself. The condensers in the receiver do not move. No motors—no relays—nothing to get out of order. And a cord no thicker than a lamp cord connects the Control to the Receiver. In all truth—there is nothing else like the Scott Radio Control. Nothing else so fine—so smooth—so perfect in operation. The pictures herewith illustrate a few of its many uses. The coupon will bring you all the facts. Mail it now.



By simply pushing buttons, the desired stations are switched in or out. The knob at the end is for volume control.



## MAIL COUPON

It will bring you full details of this great receiver—also large photographs of the many gorgeous custom-made console models it comes in. The photographs and the complete set of FACTS on the Scott World's Record A-C Shield Grid 10 will be a revelation to you. We'll also send full particulars of the new Scott Radio Control briefly described elsewhere on this page. Clip—where on this page. Clip—mail coupon today.

SCOTT TRANSFORMER CO., Dept. RN4,  
4450 Ravenswood Ave., Chicago, Illinois.

Send me full particulars of the new Scott World's Record A-C Shield Grid 10, photographs of Scott Consoles, and all the facts about the Scott Radio Control.

Name .....

Street .....

Town ..... State .....

SCOTT TRANSFORMER CO.  
4450 Ravenswood Avenue • Dept. RN4 • Chicago, Ill.



# 4 of the 40 Easy Ways to Make \$3<sup>00</sup> an Hour

## In Your Spare Time

# in RADIO

**T**HE four plans shown are but a sample of the many ways in which our members are making \$3.00 an hour upwards, spare time and full time, *from the day they join the Association.* If you want to get into Radio, have a business of your own, make \$50 to \$75 weekly in your spare time, investigate the opportunities offered the inexperienced, ambitious man by the Association.

### Our Members Earning Thousands of Dollars Every Week

The Association assists men to cash in on Radio. It makes past experience unnecessary. As a member of the Association you are trained in a quick, easy, practical way to install, service, repair, build and rebuild sets—given sure-fire money-making plans developed by us—helped to secure a position by our Employment Department. You earn while you learn, while you prepare yourself for a big-pay Radio position.

The Association will enable you to buy parts at wholesale, start in business without capital, help you get your share of the \$600,000,000 spent annually for Radio. As a result of the Association, men all over the country are opening stores, increasing their pay, passing licensed operator examinations, landing big-pay positions with Radio makers.

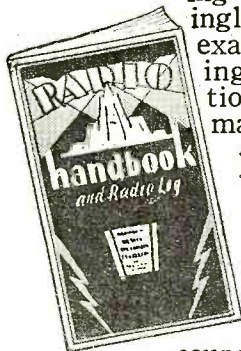

### Mail Coupon Today for the FREE HANDBOOK

It is not only chock-full of absorbing information about Radio, but it shows you how easily you can increase your income in your spare time. Mailing the coupon can mean \$50 to \$75 a week more for you.

**Radio Training Association of America**  
4513 Ravenswood Avenue Dept. RN-4, Chicago, Illinois

**Below** are a few of the reports from those now cashing in on the "40 Easy Ways"

**Clears \$3,000.00** Frank J. Deutch, Pa.—"Since joining the Association I have cleared nearly \$3,000.00. It is almost impossible for a young fellow to fail, no matter how little education he has, if he will follow your easy ways of making money."

**\$1,100.00 in 6 Weeks** J. R. Allen, Calif.—"Have done over \$1,100.00 worth of business in the last 6 weeks. Next month I am going to open up a store of my own. I never knew that money could come so fast and easy."

**\$25.00 a Week Spare Time** N. J. Friedrich, N. Y.—"I have averaged \$25.00 a week for the last 7 months even though I am not a graduate but just learning."

**Training Lands Him Job** R. C. Kirk, N. C.—"Your training has been very valuable to me. I landed a job with the big department store out here a few weeks ago because I had my membership card with me. There were a large bunch of applications ahead of me."

## ACT NOW If You Wish NO-COST Membership

For a limited time we will give to the ambitious man a No-Cost Membership which need not—should not—cost you a cent. For the sake of making more money now, and having a better position in the future, mail coupon below *now*. You'll always be glad you did.



**Radio Training Association of America**  
Dept. RN-4, 4513 Ravenswood Ave., Chicago, Ill.  
Gentlemen: Please send me by return mail full details of your Special No-Cost Membership Plan, and also a copy of your Radio Handbook.

Name .....

Address .....

City ..... State .....



# Radio News

Vol. XI

CONTENTS FOR APRIL, 1930

No. 10

JOHN B. BRENNAN, JR.  
Technical Editor

ARTHUR H. LYNCH, Editorial Director  
STUART C. MAHANAY  
Managing Editor

EDWARD W. WILBY  
Associate Editor

## In Radio News Next Month

Much speculation has been aroused concerning the future of the new pentode. A discussion of some of the practical applications of this new tube will appear in the May issue.

*S. Gordon Taylor*, in another sound-amplifier article, will tell how up-to-date hotels throughout the country are installing loud speakers in every room for the convenience of their guests.

Remote control is a coming development that will form an important part of every receiver of the future. The technical staff of RADIO NEWS will present an illuminating article on the latest advances in this field.

*Walter H. Bullock* will outline details of the changes which he made in a broadcast auto-radio receiver to adapt it for use in any motor-boat or yacht.

	PAGE
Cover—From a Painting by David Hymes	880
Frontispiece: Lieutenant William H. Wenstrom	882
Editorial	884
Sun Spots, Weather and Radio	890
<small>An informative discussion of their relationship, by LIEUT. WILLIAM H. WENSTROM</small>	
Using the Loftin-White	892
<small>By COMMANDER E. H. LOFTIN and S. YOUNG WHITE</small>	
A Tube Every Second	893
<small>The Eveready Raytheon factory's remarkable achievement</small>	
What of the Pentode?	894
<small>A discussion of a new tube which has just been announced. By ERNEST KAUER, DR. LEE DEFOREST and GEORGE LEWIS</small>	
Assemble Your Own Auto-Radio	897
<small>By SAMUEL EGERT</small>	
Amos 'n' Andy	898
<small>By H. P. W. DIXON</small>	
Radio Becomes a Talkie "Prop"	902
<small>Movie Producers have found a new application for Short-Wave Radio. By DON BENNETT</small>	
Eliminating the Hum	905
<small>The third of a series of articles on this important subject. By BENJAMIN F. MIESSNER</small>	
Television Through a Crystal Globe	906
<small>By V. ZWORYKIN</small>	
Trail Blazing the Airways by Radio	910
<small>Fifty new beacons contribute to air safety. By J. E. SMITH</small>	
An Inexpensive 1930 Broadcast Receiver	912
<small>By ROBERT HERTZBERG</small>	
Building and Installing an Auto-Radio Receiver	914
<small>By PHILIP A. EYRICK</small>	
How to Adjust and Use a Beat-Frequency Oscillator	915
<small>By JOHN E. FETZER</small>	
Exploring the Ultra-Short Waves	918
<small>An article of interest to every short-wave enthusiast. By A. BINNEWEG, JR.</small>	
Tune in As You Travel	920
<small>Canada provides radio for its Pullman passengers. By W. D. ROBB</small>	
Current Comment	922
<small>By STUART C. MAHANAY</small>	
A Universal Auto-Radio Receiver	925
<small>By WALTER H. BULLOCK</small>	
A Rebuilt Broadcast Receiver for Automobile Use	928
<small>By JOHN B. BRENNAN, JR.</small>	
Where Are Those Radio Opportunities?	930
<small>An answer to a flood of inquiries. By AUSTIN C. LESCARBOURA</small>	
A Power-Amplifier for Auditorium Use	932
<small>By HUGH S. KNOWLES</small>	
Socket-Power for the "Boy Scout" Four	934
<small>By JOHN B. BRENNAN, JR.</small>	
The Junior Radio Guild	936
Home Laboratory Experiments	940
Information Sheets	944
Manufactured Receiver Circuits	946
News from the Manufacturers	948
The Radio Forum	970
Index to Advertisers	

Published Monthly by the Experimenter Publications, Inc., at 184-10 Jamaica Ave., Jamaica, N. Y.

Member: Audit Bureau of Circulations

B. A. MACKINNON, President

H. K. FLY, Vice-President and Treasurer

Entered as Second-Class Matter at Jamaica, N. Y., under Act of March 3, 1879.

Executive and Editorial Offices, 381 Fourth Ave., New York, N. Y.

RADIO NEWS is published monthly, on the tenth day of each month preceding that of date. Entered as second-class matter at the postoffice, Jamaica, N. Y., under the act of March 3, 1879. Copyrighted 1930 by Experimenter Publications, Inc.; title

registered U. S. Patent Office. Subscription price \$2.50 a year; \$3.00 in Canada and foreign countries. Single copies, 25 cents each. The contents of RADIO NEWS are indexed in the Industrial Arts Index.



# Build Your LOFTIN-WHITE Direct-Coupled AMPLIFIER

## With the APPROVED ELECTRAD KIT

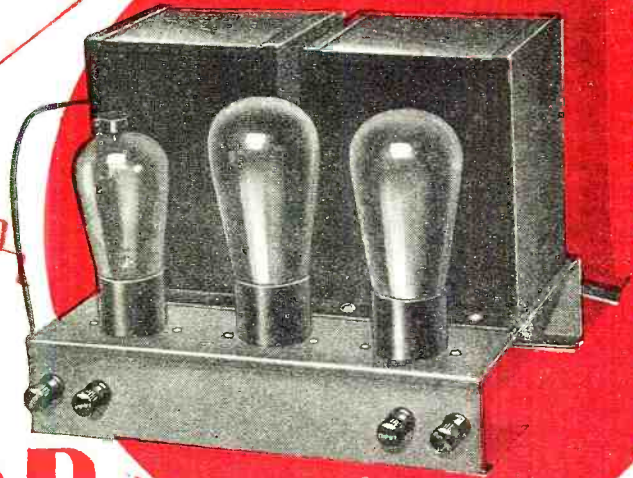

### Easy to Build and Install

Amazing simplicity in assembly and operation—fewer tubes and other parts—light weight—immense power with unlimited tone range—feature the ELECTRAD-LOFTIN-WHITE A-245 kit. Overall size of the assembled amplifier is 9" x 9" x 7 1/4" high.

### Custom-Radio Builders

The ELECTRAD-LOFTIN-WHITE A-245 Kit makes it possible for you to produce a complete receiver that will provide tone and volume at an unusually low cost, as the power transformer supplied with the kit will deliver plate and filament voltage for two additional '24 or '27 type tubes. *Investigate!*

Write Today for Custom-Builders' Proposition

The ELECTRAD-LOFTIN-WHITE A-245 AMPLIFIER KIT makes available in perfected form the revolutionary advantages of the new Loftin-White Direct-Coupled System. All parts are authorized by, and prepared in cooperation with Edward Loftin and S. Young White, the inventors.

Due to the unique circuit employed in this system, in which the plate of one tube is connected directly to the grid of the succeeding tube, perfect operation depends almost entirely upon the resistances which supply the voltage to the tubes. *These must be accurate, or performance is impaired.*

Hence, it is only natural that, in the development of their circuit, the inventors should take their resistance problems to the famous ELECTRAD Laboratory—and many of the refinements of the present circuit were developed there.

ELECTRAD'S consistent leadership in the design and manufacture of radio resistances merit this confidence. Let it be your safeguard and guarantee of results, for the name "ELECTRAD" on a radio product is a sign of highest quality that needs no apology.

ELECTRAD-LOFTIN-WHITE A-245 Direct-Coupled AMPLIFIER KIT, for A. C. operation. Complete parts, including metal chassis, assembly and operating instructions (Less Tubes) List Price, \$35.

The ELECTRAD-LOFTIN-WHITE A-245 Direct-Coupled AMPLIFIER with self-contained A. C. power supply, as constructed from the ELECTRAD-LOFTIN-WHITE A-245 Kit Utilizes one '24, one '45 and one '80 type tube. Delivers immense undistorted output with unusual tone perfection.

175 Varick St., New York, N. Y.

# ELECTRAD INC.

MAIL COUPON FOR LOFTIN-WHITE FOLDER  
ELECTRAD, Inc., Dept. RN4 175 Varick St., New York, N. Y.  
Please send details on the ELECTRAD-LOFTIN-WHITE A-245 Direct-Coupled AMPLIFIER KIT.  
Name \_\_\_\_\_  
Address \_\_\_\_\_



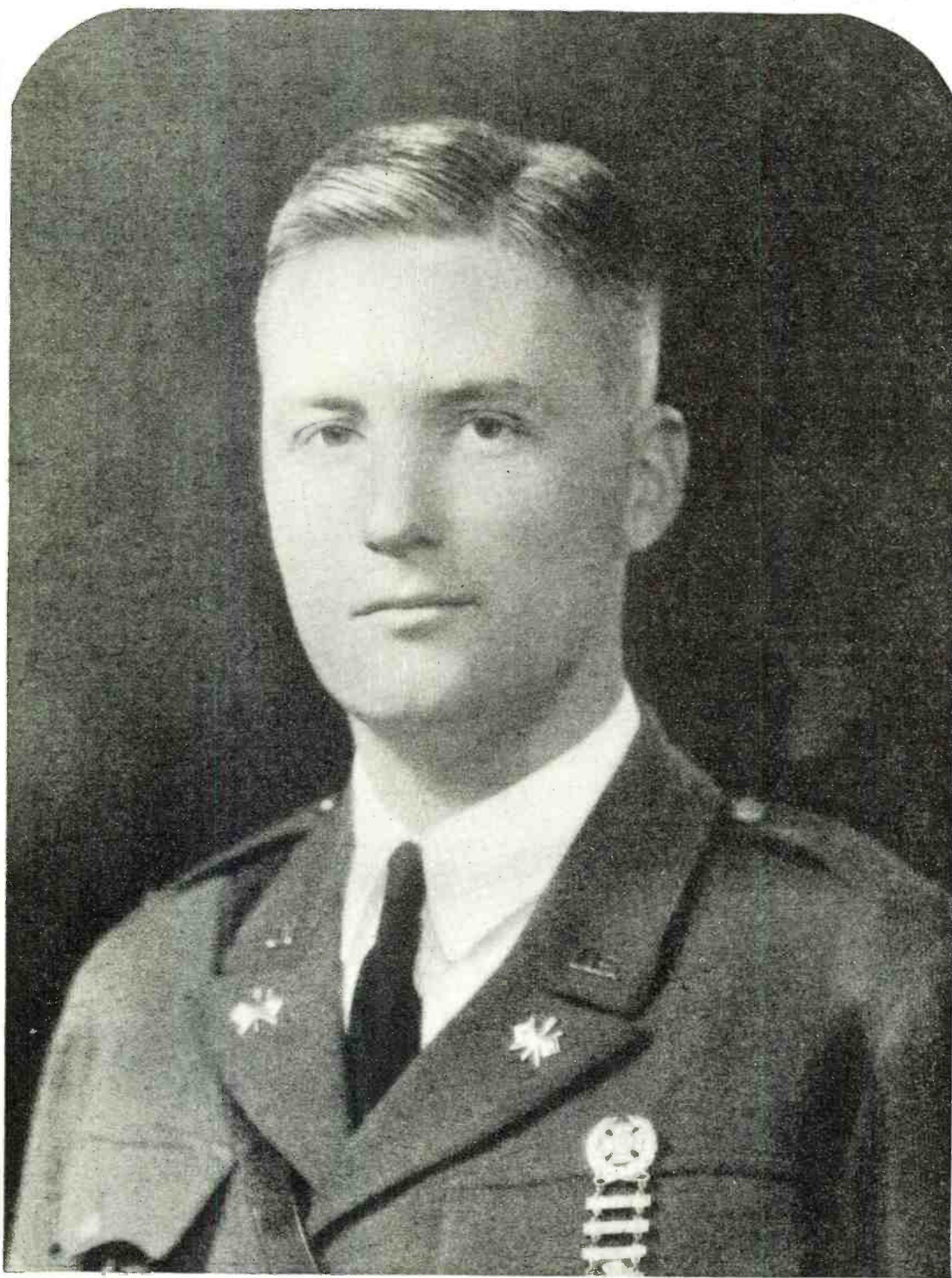

White Photo

Lieutenant William H. Wenstrom



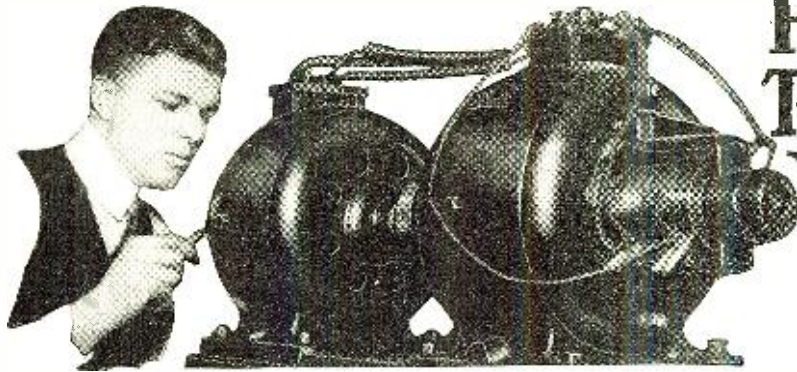

# Fellows I Have Trained Will Tell You That You, Too, Can Cash In On

# ELECTRICITY

## Not By Correspondence

"First I enrolled with a School teaching Electricity by correspondence. I tried to work out several lessons, but quit when I saw your ad. telling how you taught Electricity by actual work. I didn't have much money when I went to Coyne, but through your Employment Department I was able to work for my room and board. Three days after graduating you got me a good job with a Battery and Electric Shop, and a year later I bought a Shop of my own. I now have a \$1300 car and a thriving business—all paid for."

George W. Stoneback, Illinois

## Lands a Job at \$8,000 a Year

"Before going to Coyne, I was an ordinary mechanic. Now I make \$300.00 a month, and am accepting a new position the first of the year as Chief Electrician at \$8,000 a year. Any man who works for me will have to be a Coyne graduate."

Stanley Zurawski, Michigan.

## From \$20.00 a Week to \$100.00 a Week

"Before going to Coyne, I had worked in a garage for five years at \$20.00 a week. I had no advanced education and didn't know a volt from an ampere. Yet I graduated in three months with a grade of 98%. Since I left Coyne, I have jumped from \$20.00 to \$100.00 a week, and am still going strong. I owe all my success to the practical training I got in the Coyne Shops."

Harry A. Ward, Iowa.

"I knew nothing about Electricity, before I went to Coyne," says Nolan H. McCleary. "I had no advanced education and so little money that I could never have stayed at school, if Mr. Lewis hadn't gotten me a part-time job. Yet I finished the course in twelve weeks, and the School immediately placed me in a fine electrical job. Now I am Chicago District Manager of the largest electrical concern of its kind in the world, making more money than I ever dreamed of making before I went to Coyne. I am convinced that there is but ONE RIGHT WAY to learn electricity and that



**NOLAN H. MCCLEARY**  
Chicago District Manager, Beardsley-Wolcott Co.  
is the way of the Coyne School—BY DOING ACTUAL ELECTRICAL WORK YOURSELF UNDER EXPERT INSTRUCTORS, ON FULL-SIZE, RUNNING ELECTRICAL MACHINERY AND EQUIPMENT."

For thirty years Coyne has been training men for responsible, Big-Pay electrical jobs—NOT BY BOOKS OR CORRESPONDENCE, but by an amazing way to teach that makes you a practical Expert in 90 days. You need no advanced education or previous experience. I don't care if you don't know an armature from a generator; if you're sixteen years old or forty. IT MAKES NO DIFFERENCE! I will prepare YOU for a fascinating, Big-Pay electrical job in twelve weeks time. I will allow you your railroad fare to Chicago—help you get part-time work while at School—and give you every assistance in locating just the job you want when you graduate.

## Says You Can Make \$60.00 to \$200.00 a Week

"Before going to Coyne, I made thirty cents an hour. I borrowed the money for my tuition and you got me a part time job that took care of my expenses. I graduated in twelve weeks, returned home and started doing wiring on contract. In a year's time, I had paid for my schooling, bought a car and had a nice shop of my own. In your catalog you say a fellow can make \$60.00 to \$200.00 a week. I have done better. In July I made \$150.00 to \$200.00 a week, and I have made as high as \$75.00 a day."

Joseph F. Hartley, West Virginia.

## His Advice—'Go To Coyne'

"Some fellows try to learn Electricity by just working at it. Others send away for correspondence courses in it. But my advice to anyone who really wants to learn Electricity is TO GO TO COYNE. They have all the electrical equipment right in the school that you will ever see in the field. NO PICTURES OR USELESS THEORY. They show you just how to do everything you will have to do on the job."

R. M. Ayers, Louisiana.

## Nothing Compares to Practical Training

"Before going to Coyne, I took a correspondence course in Electricity, but it was too deep for me and I lost interest. Then I got your catalog, saw how you let the student actually work on electrical equipment, and decided to go to Coyne. At that time I was only making \$9.00 a week. Now I make \$68.00 a week straight time, have a Hudson car and own my home—where before I could hardly pay rent."

D. G. Emerson, Michigan.

## LET ME SEND YOU THE SAME BIG FREE BOOK THAT BROUGHT SUCCESS AND BIG PAY TO ALL THESE MEN—SIMPLY MAIL THE COUPON

Find out how QUICKLY and EASILY you can land a Big-Pay Electrical Job! IT COSTS NOTHING TO INVESTIGATE! Just mail the coupon and let me send YOU the same Big Free Book that started all these other fellows on the road to success. This doesn't cost you a cent, nor does it obligate you in any way. GET THE FACTS. Mail the coupon—NOW!

**Coyne Electrical School, H. C. Lewis, President, Founded 1899**  
500 S. Paulina St. Dept. 40-76 Chicago, Ill.

## MAIL THIS COUPON—NOW!

Mr. H. C. LEWIS, President  
COYNE ELECTRICAL SCHOOL, Dept. 40-76  
500 S. Paulina St., Chicago, Ill.

Dear Mr. Lewis:  
Without obligation send me your big free catalog and all details of Railroad Fare to Chicago, Free Employment Service, Radio, Aviation Electricity, and Automobile Courses, and how I can "earn while learning."

Name .....

Address .....

City..... State.....



## Pentodes?

**T**HERE is no question but what we will have five-element tubes this year. The Pentode, as it is called, is a sort of glorified screen-grid tube. It will enable us to secure high amplification and increased power output at the same time. At least these are some of the claims being made for it.

Every so often the radio business suffers a revolution. This revolution generally occurs at about the time manufacturers are heavily laden with inventories of receivers in which the revolutionary devices are not incorporated. When the screen-grid tube was introduced many manufacturers had rather heavy inventories, and, in addition, had done most of the engineering work on their advance models for the coming year. A great many of them discarded all their past work and made all sorts of engineering compromises in order to swim with the tide and provide a screen-grid receiver for their dealers.

The result of the stampede was the construction of a group of screen-grid receivers designed in haste, the production of screen-grid tubes designed in haste, and a most unsatisfactory merchandising situation.

That the screen-grid tube was an absolute essential for any receiver that would enjoy ready sale was completely disproved by the tremendous sale of Majestic and Victor receivers. In fact, the former sold more receivers without screen-grid tubes than the combined sale of all the screen-grid receivers.

The shrinkage (loss in process of manufacture) of screen-grid tubes is very high. There are comparatively few which actually measure up to the wonderful qualifications first claimed for them. Tube manufacturers agree that manufacturing difficulties increase about as the square of the number of tube elements. The average shrinkage in a good plant making screen-grid tubes is about fifty per cent. According to sound engineering estimates, then, the pentode will greatly increase the shrinkage.

There are at present many very satisfactory radio receivers. They are sensitive, selective and produce extremely fine tone quality. They may be operated for approximately one cent an hour and their original price is very, very low. It is rather difficult to conceive of the pentode so greatly improving any of them as to make it necessary for manufacturers to abandon completely the manufacture and sale of present models even if the tone quality was as good, and we have yet to hear a pentode receiver capable of the tone fidelity or in any other way the equal of good receivers with standard tubes.

Furthermore, the impression that the pentode is a new tube is completely erroneous. Pentodes have been in use in Europe for more than five years. They have not revolutionized the radio receiver business there, and abroad there is a much greater tendency toward economy in receiver design than there is here. The vacuum tube is generally recognized as the heart of the radio receiver, and it is apparent that a tube company announcing a new and revolutionary tube would be able to exploit an unknowing public by floating a stock issue on the strength of cleverly trumped-up propaganda.

There is no doubt but that there are many fields in which this tube can be employed to advantage. For instance, a suitable pentode used for the power output in automobile radio receivers would enable us to secure satisfactory volume without having to resort to particularly high plate voltage. There are, however, certain characteristics in connection with the development of pentodes which must be overcome before the tube will be satisfactory for home or mobile use. In some of the models of American manufacture which we have seen, the elements are extremely close together. In fact, in one tube where a ribbon filament was employed, the ribbon had to be placed on edge to prevent its striking one of the grids. Such a tube would hardly be useful in an automobile, on a motorboat or in an airplane, even though, theoretically, it would reduce the number of tubes in the receiver.

It is our purpose to gather as much information as we can concerning pentodes, and to convey this information to our readers. We are at present co-operating with a number of tube manufacturers in making a survey of the possible production of pentodes and their actual application.

*Arthur H. Lynch*



**R. T. I.**

**R. T. I. QUALIFIES YOU TO MAKE MONEY AND ITS SERVICE KEEPS YOU UP-TO-THE-MINUTE ON THE NEWEST DEVELOPMENTS IN RADIO, TELEVISION, AND TALKING PICTURES**

**R. T. I.**

**RADIO TELEVISION-TALKING PICTURES**

**TUNE IN ON R.T.I.**

**BIG MONEY NOW!**

**More to Come**

**Radio now offers ambitious men the greatest Money-Making Opportunity the world has ever seen!** Hundreds of trained service men are needed by radio dealers, jobbers, and manufacturers!

**GOOD JOBS** are open for men in all of the many branches of Radio, where qualified men easily earn \$60 to \$100 per week and even \$10,000 a year jobs are plentiful.

**BIG MONEY** for Spare-Time Radio Work is easily made in every city and village. You can now qualify for this Big-Money work quickly through R. T. I. Get the Big Money Now and go up and up in this Big Pay field. The Radio industry calls for More Men, and R. T. I. supplies what the industry wants you to know.

**No Experience Needed**

ALL YOU NEED is ambition and the ability to read and write. The Radio industry needs practical trained men. Remember, R. T. I. makes it easy to earn spare time money while you learn at home.

**More to come**

THE MEN who get into this Big-Money field now will have an unlimited future. Why? Because this billion dollar Radio industry is only a few years old and is growing by leaps and bounds. Get in and grow with it. \$10 to \$25 per week and more is easily made in spare hours while you are preparing for Big Money. TELEVISION, too, will soon be on the market, so the leaders say. Be ready for this amazing new money-making field. Remember, R. T. I. "3 in 1" home-training gives you all the developments in Television and Talking Picture Equipment, together with the complete Radio Training.

**Supervised by Radio Leaders**

R. T. I. training is prepared and supervised by prominent men in radio, television and talking picture engineering; distributing; sales; manufacturing; broadcasting, etc. These men know what you must know to make money in Radio. You learn easily in spare time at home with the R. T. I. wonderful combination of Testing Outfits, Parts, Work Sheets, Job Tickets.

It is easy, quick and practical, covers everything in Radio —includes Talking Pictures and the latest in Television. Get started in Big Money Radio work now.

**Warning**

Do not start R. T. I. training if you are going to be satisfied to make \$15 or \$20 per week more than you are now. Most R. T. I. men will make that much increase after a few weeks. There is no reason to stop short of the Big Money Jobs or the Big Profits in a spare time or full time business of your own. No capital needed. Get started with R. T. I. now. Make money while you learn at home.

**R. T. I. Book Now**

**FREE**

The thrilling story of Radio, Television and Talking Pictures is told with hundreds of pictures and facts — its hundreds of big money jobs and spare time money-making opportunities everywhere.

Send for your copy now. **USE THE COUPON.**



**LET F. H. SCHNELL AND R. T. I. ADVISORY BOARD HELP YOU**

Mr. Schnell, Chief of the R. T. I. Staff, is one of the ablest and best known radio men in America. He has twenty years of Radio experience. First to establish two-way amateur communication with Europe.

Former traffic manager of American Radio Relay League, Lieutenant Commander of the U. S. N. R. Inventor and designer of Radio apparatus. Consultant Engineer to large Radio manufacturers.

Assisting him is the R. T. I. Advisory Board composed of men prominent in the Radio industry.

**\$60-\$70-\$80-PER WEEK AND UP.** That's what R. T. I. training leads to. Send for the R. T. I. Book and see for yourself.

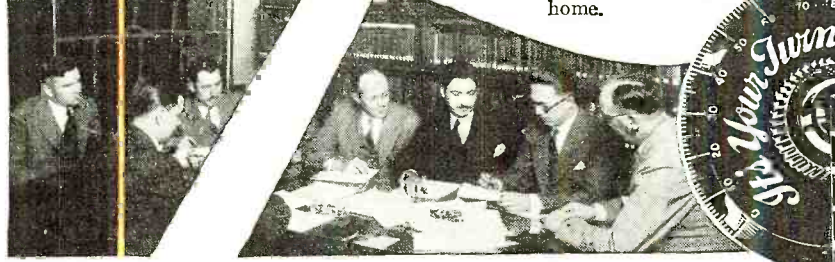

**THE R. T. I. ADVISORY BOARD.** These men are executives with important concerns in the radio industry—manufacturing, sales, service, broadcasting, engineering, etc., etc. They supervise R. T. I. Work Sheets, Job Tickets, and other training methods.

**RADIO & TELEVISION INSTITUTE**  
Dept. 884, 4806 St. Anthony Ct., Chicago

**RADIO & TELEVISION INSTITUTE**  
Dept. 884, 4806 St. Anthony Court, Chicago

Send me Free and prepaid your **BIG BOOK** "Tune In On Big Pay" and full details of your three-in-one Home Training (without obligating me in any way).

Name.....  
Address.....  
City..... State.....

**R. T. I. R. T. I. TRAINS YOU AT HOME FOR A GOOD JOB OR A PROFITABLE PART TIME OR FULL TIME BUSINESS OF YOUR OWN**



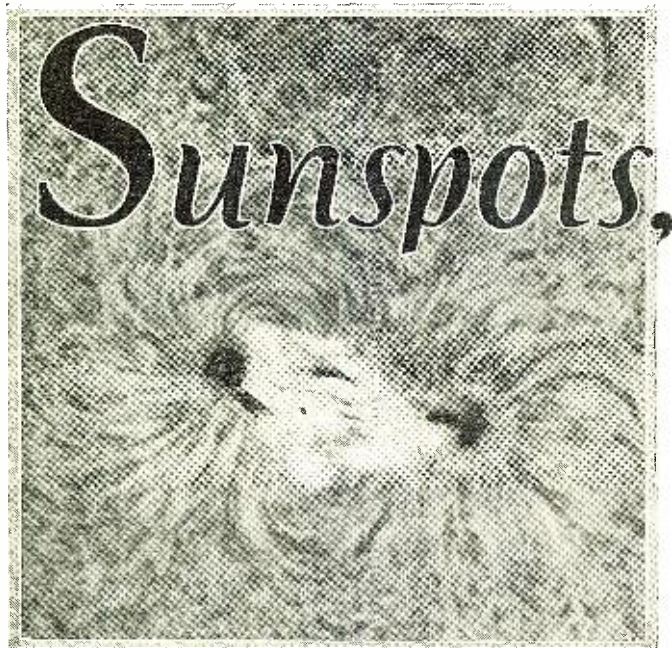

Mt. Wilson spectroheliograph of hydrogen whirls around a bipolar sunspot group. This photograph was taken in light of a single wavelength, and shows that the spots are in reality gigantic tornadoes

*Scientists Are Generally Agreed That There Is a Definite Relationship Between Sunspots and Weather. Since They Also Produce Marked Effects on Radio, Study of These Phenomena, Especially on the Short Waves, Has Been Productive of Some Entirely New and Frequently Controversial Theories*

ON December 16, 1929, had you looked carefully at the sun through a bit of smoked glass, you would have seen what appeared to be a minute black spot, nearly central on the sun's disk and pointed directly towards the earth. In reality this phenomenon, which only appeared insignificant by reason of its great distance, was a gigantic solar tornado raging over an area into which our whole earth could be dropped like a golf ball into a hat, and entailing white-hot "winds" which often blow at the incredible velocity of fifty thousand miles an hour.

Between December 16th and December 19th some uncommonly violent weather occurred in the United States and all over the world. The eastern air mail was fog-bound for four days—the worst delay in its history. The marine traffic of New York was at a standstill for a similar period, and on the fourth day a passenger liner was rammed and sunk in Ambrose Channel. The Mid-West suffered from the worst blizzard in ten years—a score of people were frozen to death. Even in Louisiana hurricanes and near-zero temperatures caused widespread suffering and damage. Gales over northern Africa forced a British airplane bound for Cape Town to crash in Tunis. The temperature dropped abruptly in Cuba; far-away Naples saw Vesuvius snow-capped for the first time of the season. On the other side of the world China was swept by rain and snow storms, and many people perished from cold in Peking.

For the week following December 16th radio broadcast reception in the United States was below its normal winter value. On December 17th and 18th reception was particularly bad in the eastern United States—so bad that stations over 600 miles distant were received very poorly if at all. In

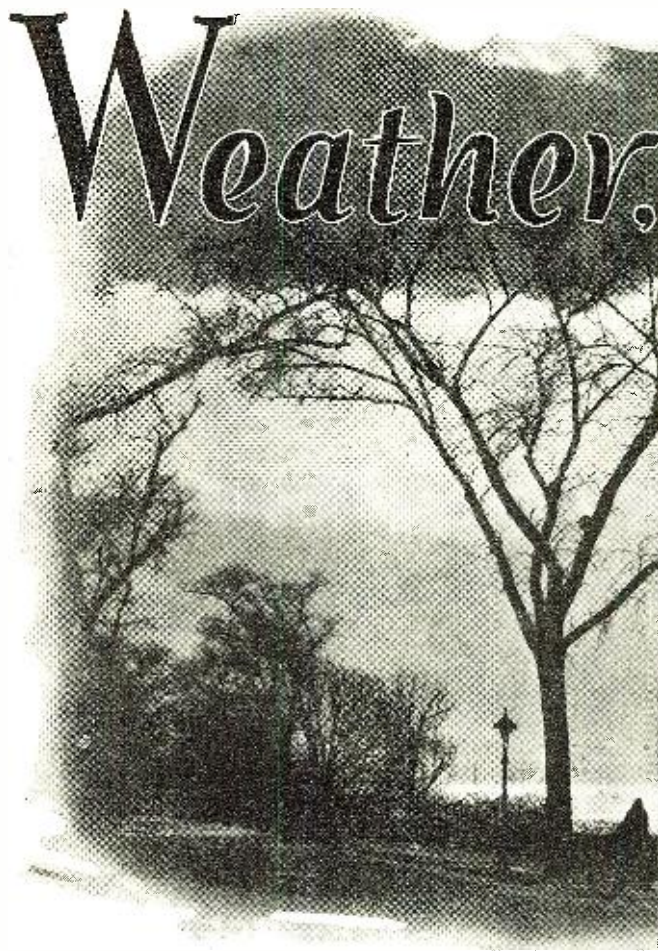

addition, a great deal of "grinder" and "crashing" static further marred reception.

It seems plausible enough that these diverse but roughly simultaneous events were in some way connected. Perhaps our first tendency, once the connection becomes apparent, is to consider it almost a certainty. But we also know that violent weather sometimes occurs when there are no spots on the sun, and subnormal radio reception may accompany calm weather with or without sunspots. The problem is really more complex than some surface appearances would indicate. Nevertheless, careful observation over a period of several years has begun to link sunspots, weather and radio in some fairly definite relations. The purpose of the present article is to explore part of this somewhat controversial but highly interesting ground.

#### *The Sun as a Gigantic Furnace*

To put the horse before the cart and causes generally before results, we must leave for a time the earth and its vicinity by some ninety-three million miles. The sun is an immense ball of glowing gas nearly a million miles in diameter. Near the center its temperature probably runs into millions of degrees. The photosphere, or surface layer that we see as a disk of blinding light, glows at about 6000° Centigrade or 10,000° Fahrenheit—hotter by far than the highest temperature which man produces on earth. It is difficult to appreciate what such a temperature means in the way of power. At the photosphere, solar radiation would melt in one minute a shell of ice nearly forty feet thick, and a section of solar surface the size of a thumbnail would develop energy continuously at the rate of forty horsepower. To indicate the total horsepower radiated continuously by the entire sun, we must write the number 465 followed by twenty-one zeros!

Toward the sun's center, pressures and densities are very great, but at the photosphere they are comparable to those of the air we breathe. Just above the photosphere is the



## By William H. Wenstrom

Lieutenant U.S. Army



**T**HE correlation of weather and sunspots as they affect reception is one of the newest and most fascinating subjects in radio. The subject is so alive, in fact, that many controversial opinions are held. We believe that this article by Lieut. Wenstrom is the first broad, general survey of the entire field presented in a readable and non-mathematical way. It represents, rather than any one particular opinion, the carefully weighed mean of all the best scientific opinion. As the author points out, there is a real necessity for considering everything at once—radio, magnetic storms, auroras, weather and solar activity—rather than confining one's investigation to any one or two of these things.

so-called reversing layer which causes the dark spectral lines, and above this lies the cromosphere, seen as an irregular ring of red light during eclipses. Beyond the chromosphere there extends out for millions of miles the faint, pearly corona, visible only during a total eclipse.

If we look at the sun through a telescope (equipped, of course, with some device for cutting down the excessive light), we note that the surface darkens perceptibly towards the edge or "limb," and perhaps see a few bright flecks on this darker surface, called faculae. By tapping the telescope we may also see that the whole solar surface is granular—the "rice grain structure"—each grain being some 300 miles in diameter. This structure is constantly changing, like the waves of a sea. By the application of the laws of light it has been found that the sun has a magnetic field, much like the earth's in general character, though 100 times as strong. The entire

solar globe rotates on its axis, with the higher latitudes lagging somewhat behind the equatorial belt, in an average period of 25.4 days. But during a rotation the earth has moved in the same direction along its orbit, so that to us the period appears to be 27.3 days.

#### *The Earth in Relation to the Sun*

The earth and its moon circle perpetually in the glare of the great sun. Night and day they are bathed in its tremendous blaze of radiation. Though the earth itself receives but an infinitesimal fraction of the sun's total outpour of energy, even this fraction amounts continuously to twenty-three thousand billion horsepower. The sun is the engine which drives our winds and our weather, and makes the earth livable for man. The coal and oil which keep us warm in winter are only particles of the stored sunlight of the past, as water power is the stored sunlight of the present. Every factory wheel turns, every radio message speeds, every boat, train and airplane moves only by the delayed impetus of solar energy.

Perhaps we can best visualize these relations by means of a model. The sun is a ball 22 feet in diameter—about the same size as an average living room. Half a mile away moves a tennis ball earth; attended in turn by a moon the size of a small marble, circling around its "earth" at a distance of about six feet.

The outpour of solar energy takes many forms. First of all there are electromagnetic waves of many lengths. The long infra red or heat waves begin where the shortest radio waves leave off. Then at about 7,000 Angströms (the unit of light



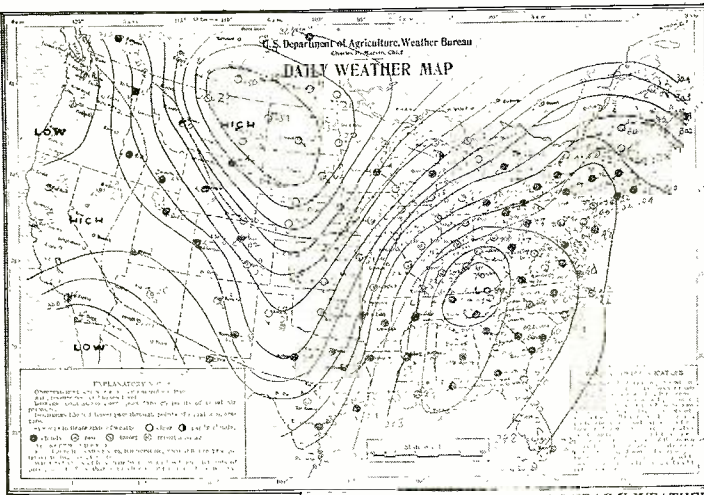

Above, a daily weather map released by the Department of Agriculture Weather Bureau, showing the conditions existing on December 18, 1929, and showing the barometric gradient nearly twice as steep as average. To the right, a daily weather map showing average winter conditions

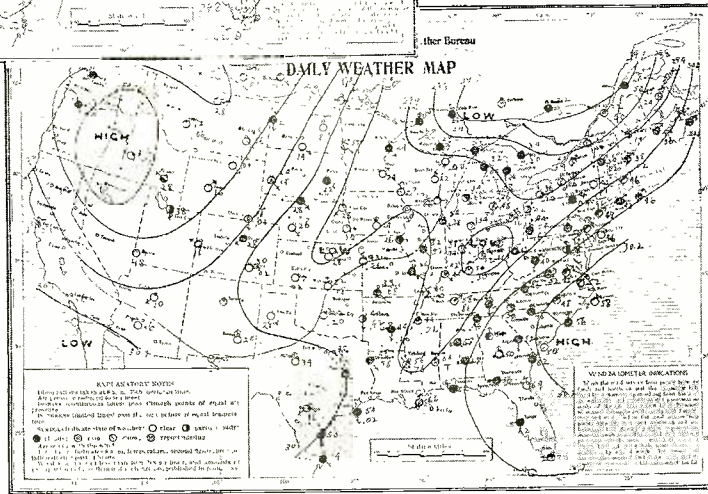

measurement — one ten-millionth of a centimeter) visible light begins with red and extends through yellow, green and blue to violet. The sensitivity of the eye ceases at about 4,000 A, but ultra-violet solar radiation continues to penetrate the atmosphere down to about 2,900 A, as summer sunburn well attests. The solar waves extend down to 500 A and even below, but this extreme ultra-violet is absorbed in the higher levels of our atmosphere. In addition to electromagnetic waves the sun shoots off actual electrons ( $\beta$  particles) and ions ( $\alpha$  particles) at terrific velocities, somewhat after the manner of the incandescent filament of a vacuum tube. Another possible solar influence is changed in its magnetic field, although these are probably too small for any measurable effect at the earth's distance.

*Solar Disturbances*

Usually the chromosphere is blotted out by the blinding photosphere, but during a total eclipse or a spectrohelioscope it becomes visible. It is then seen to be very irregular at its outer edge, with great red, flame-like prominences often rising a hundred thousand miles or more above the general surface. Quiescent prominences often keep their general form for days on end, and are probably caused by the luminous excitation of diffused hydrogen and helium clouds often present at these heights. Eruptive prominences, however, are gigantic explosions wherein the metallic vapor travels outward at 100 or more miles per second, reaching heights of two or three hundred thousand miles. Truly these great flames make the largest earthly volcano appear as a mere firecracker! They are one of the most magnificent sights in nature.

But the prominences, splendid as they are, seldom become visible to the eyes of most of us. Far more easily observed are the sunspots. These appear through the telescope, or through binoculars when large, as dark spots on the photosphere. They are roughly circular in shape, though many are irregular, and they often occur in groups. The center of a spot (called the umbra) is darker than the outer ring (penumbra). They usually begin in a small black point which grows into the umbra. Then the penumbra fills out. After a few days, or more likely after a month or two, the penumbra closes inward over the umbra and destroys the spot. As the temperature inside the spot is about 2,000°C below that of the surrounding photosphere, it may be called the greatest refrigerator in the universe! Smaller spots are only a few hundred miles in diameter, while larger spots or groups may be fifty thousand miles wide. Occasionally (as in December, 1929) they are visible to the unaided (but protected) eye.

The causes of sunspots are unknown, but it is known that they are great cyclonic whirls or vortices—great "solar storms resembling ter-

restrial tornadoes, in which the hot vapors, whirling at high velocity, are cooled by expansion"—Hale calls them. The whirling motion of hydrogen clouds around two spots is beautifully shown in the Mt. Wilson spectroheliograph.

Naked-eye sunspots have been noticed by the Chinese for centuries, but the first man to study them seriously with a telescope was Schwabe of Dessau, an apothecary by trade and an amateur astronomer. His pills are long since forgotten, but his patient observations through the years established the 11.4-year cycle of sunspot variation, the underlying basis of all present correlation work. With a new cycle, spots begin to break out about 30° north and south of the sun's equator. In a few years, with maximum activity, most of the spots are much nearer the equator; and the cycle finally dies out near 10° north and south latitude as the next cycle is getting under way in higher latitudes. The sun bursts into activity with comparative suddenness—in about four years—and simmers down more slowly through about seven years. The last

Does violent weather follow sunspots? These newspaper headlines are dated December 18 and 19, 1929. A great sunspot, visible to the naked eye, was central on December 16th. At the bottom of the page, sunspot numbers for the last hundred years. The rise and fall of the 11.4 year maximums and minimums is clearly shown

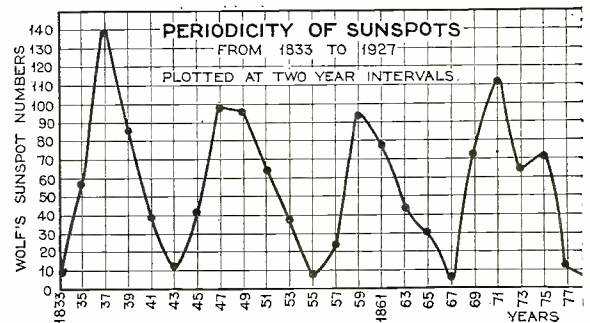
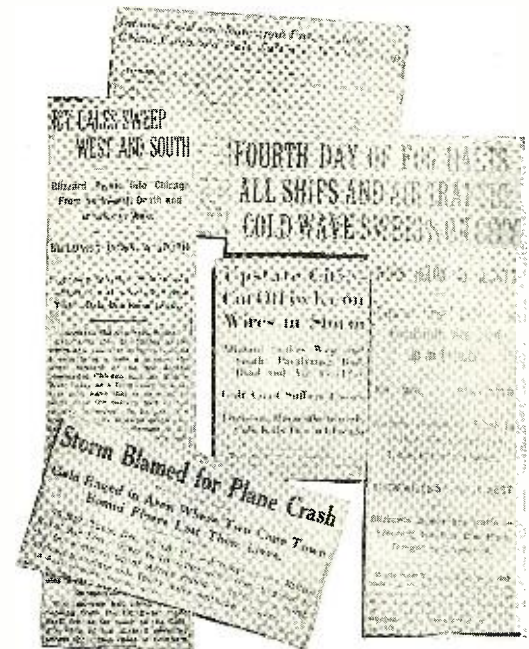



maximum was scheduled for 1928; but 25-month and 15-month fluctuations are superimposed on the slower and larger one. As a result the actual peak probably came late in 1929. In addition there is a 27-day period imposed by the sun's rotation.

Most correlation data uses the sunspot numbers originated by Wolf and carried on by Wolfer. The value of this number for any particular day is given by the formula:

Number = constant  $\times$  [10 (number of groups and isolated spots) + total number of spots].

The value of the constant depends on the telescope, observer and conditions, being considered unity for a three-inch telescope magnifying 64 diameters.

The effect of sunspots on radio and auroræ is generally explained by considering that narrow, curving streams of high-velocity ions and electrons are shot out from the spots or near them. These streams rotate with the sun, like the rays of an aircraft beacon; and when they sweep by the earth we are deluged with electrons which ionize our upper air gases to such an extent that we notice these earthly phenomena. Hale has shown by very intricate light measurements that a sunspot is a great electromagnet having an intense field, produced probably by the free electrons and ions in its rotating gases. This field extends out in a more or less directed way like the field of a bar magnet. The two spots of a pair usually present opposite poles. The lines of force from spot fields may pos-

(Below) Successive photographs of the sun's northern hemisphere showing rotation. In the upper picture a spot group is just coming on the eastern edge; in the lower it is nearly central

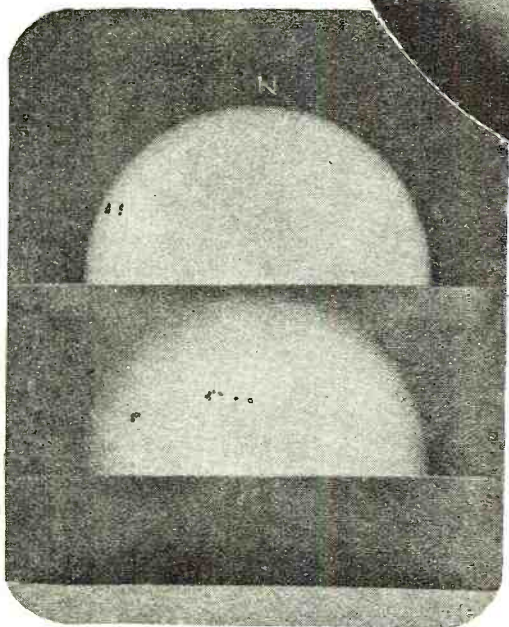

Photograph courtesy of Harvard Astronomical Laboratory

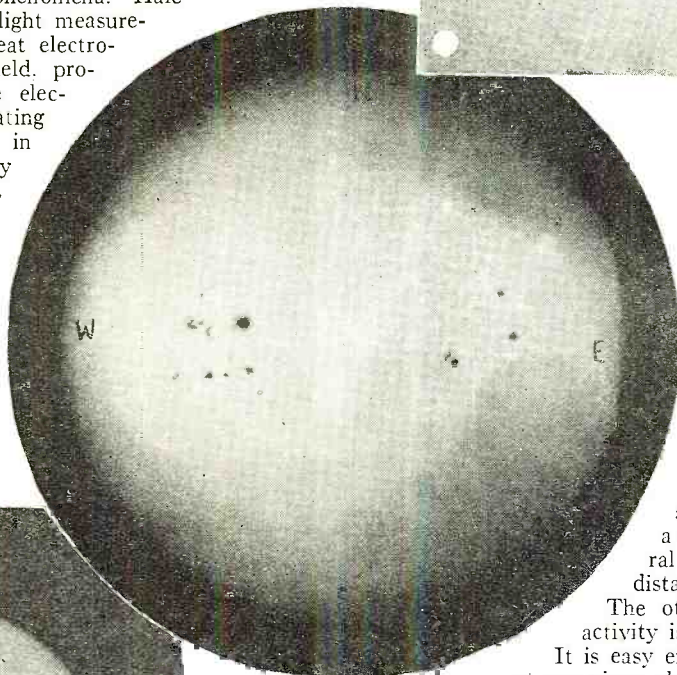

Sunspot group as seen through a telescope. The white disk showing the comparative size of the earth, which could easily be dropped into one of the disturbances

THE SUN OF DECEMBER 14, 1929. The great spot on the left, plainly visible to the unaided eye, was the central two days later on the 16th. Strange radio and weather effects followed on the earth

sibly sweep by the earth in such a way as to cause radio and auroral changes, but in view of the great distance this effect is doubtful.

The other common measure of helioactivity is the solar constant of radiation. It is easy enough to determine this quantity at any given place where instruments can be set up, but the measurements will vary greatly with differences in the air. By extensive researches Abbot has found means of accurately determining its value *outside* the earth's atmosphere, and has fixed its average value at 1.945 calories per square centimeter per minute. The constant is slightly higher than the mean in sunspot maximum years, and slightly lower in minimum years. In addition, it may vary from day to day, or stay above or below the mean for months. Most observed variations have been less than five per cent. The constant is, of course, the measure of total radiation on all wavelengths; the shorter ultra-violet waves often vary in amplitude by a much greater percentage.

The great prominences described above are often observed near sunspot groups, more or less surrounding them, and this is particularly true of eruptive prominences. The bright faculae (from Latin "little torch"), supposed to be elevations of the photosphere, are also surrounded by prominences. The faculae themselves, though seen all over the sun and particularly well near its edges, are most numerous near sunspot groups. In addition there are bright clouds of low-lying calcium called flocculi (from Latin "tuft of wool"), and also dark flocculi which are clouds of calcium or hydrogen at high levels in the chromosphere. These dark flocculi are often observed being drawn into the upper levels of sunspots. Nor are these all the observed solar changes, for the delicate, widespread corona gathers itself into long equatorial streamers and short polar tufts at sunspot minimum, and spreads out in all directions at maximum.

Maris and Hulburt have postulated a different type of solar disturbance as the cause of earthly phenomena. Their theory, which appears important and may ultimately supplant the electron stream idea more widely held, assumes that a "hot spot" breaks out on the sun—an eruption of internal gases perhaps five times as hot as the photosphere. Assuming that the hot spot covers one ten thousandth of the sun's visible surface (the size of the earth's disc), they have shown that, although the solar constant increases only one per cent., the ultra-violet radiation increases enormously—between 1,000 and 500A, for example, by one hundred thousand times. As the short ultra-violet waves are all absorbed in the earth's higher atmosphere,

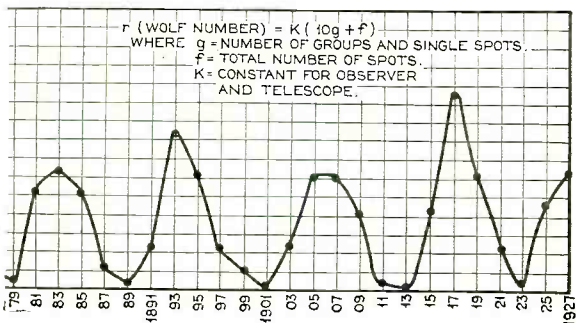



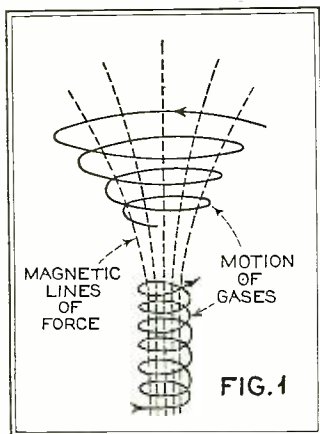

The magnetic field of a sunspot, showing the motion of gases and magnetic lines of force

they may cause many marked effects, such as sudden heating, which are capable of causing observed events.

It is essential that we appreciate the stupendous power of the sun and the magnitude of its variations. The solar disturbances are very complex, and our understanding of their real nature is far from complete. Sunspots are perhaps themselves effects rather than ultimate causes; however, they are easily seen and form a convenient gauge of the sun's activity. Spots and prominences are as new and as fascinating a field of investigation for the amateur astronomer as is correlation work to the radio experimenter.

*Magnetic Storms and Auroræ*

The earth itself is a great magnet having a widespread but rather weak field. Ship and airplane compasses are basically magnetized needles which indicate the direction of this field's horizontal component. The earth's magnetic poles are fairly near opposite geographic poles, the south magnetic pole being in far northern Canada. A needle, therefore, does not point towards true north but deviates from it by an amount called the declination. In the eastern United States the needle deviates westward, and on the west coast it deviates eastward. The declination varies slightly through the day and from year to year. But the swinging of the needle is much greater at some times than at others, and marked changes in field direction are usually accompanied by changes in field strength. The indication of the intensity of these changes is called the magnetic character of the day, and is tabulated at many observatories. In general, magnetic activity is higher in years of sunspot maximum and lower in minimum years.

Sometimes the changes in field direction and strength are sudden and violent; the needle may swing several degrees within an hour, and the field strength may vary by five per cent. The ragged field intensity curve rises sharply through one or two hours, falls during several hours to below normal, and slowly recovers during one or two days; these fluctuations usually occur at nearly the same time over the whole earth. Such a disturbance is called a magnetic storm, and it usually breaks out when a large sunspot group is pointed toward the earth.

Simultaneously with the beginning of a magnetic storm,

The earth and its moon circle perpetually in the glare of the great sun. This model shows them as they might appear in a telescope on an outer planet such as Mars. The moon is somewhat behind the earth, foreshortening the apparent distance between them

Cirrus clouds. These wispy, veil-like high altitude clouds, spreading up out of the west, are a certain indication of the coming of a "low" with rain and storm

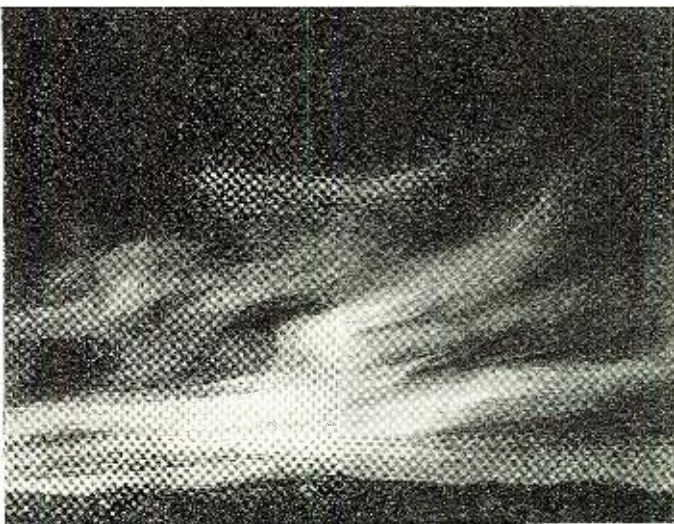
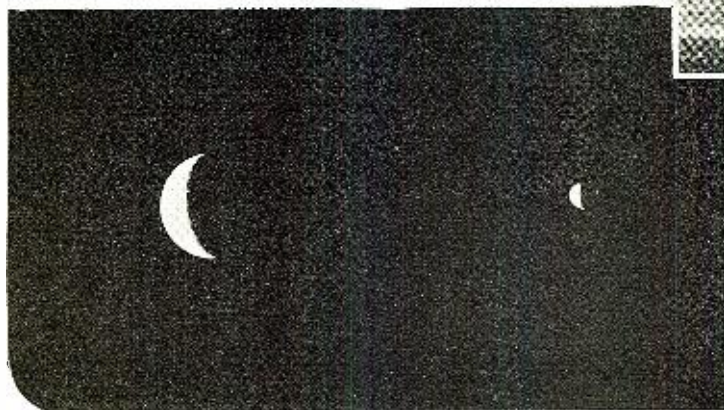

that the aurora is a great cloud of ions which can act as a radio screen; signals apparently reflected from it have been noted in England.

The more brilliant and southward-visible displays are closely linked with sunspots. During the seventeenth century, when practically no sunspots were visible for seventy years, there were no auroræ either; and in general aurora maximum years are sunspot maximums also. In addition, the passage of a large sunspot group across the center of the disk usually means a strong aurora as well as a magnetic storm. The conventional theory holds that electron and ion streams from the sun tend



to complete their earthward journey along the earth's magnetic force lines, causing greater ionization and consequent luminescence near the magnetic poles. The "hot-spot" theory holds that ions from the earth's own atmosphere, having been "blasted" to great heights by ultra-violet energy from the sun, fall back to earth generally along the magnetic force lines and form an ion cloud having its greatest density near the crossing of 67° magnetic latitude with the 9 p. m. line. Which of these theories more closely approaches the actual truth, only time and research can decide; it is probable that both causes are active.

**Sunspots and Radio Transmission**

Whatever their origin, the ions arriving near the magnetic poles would tend to migrate equatorward, spreading in time a diffused ionization over large areas. Changes in other

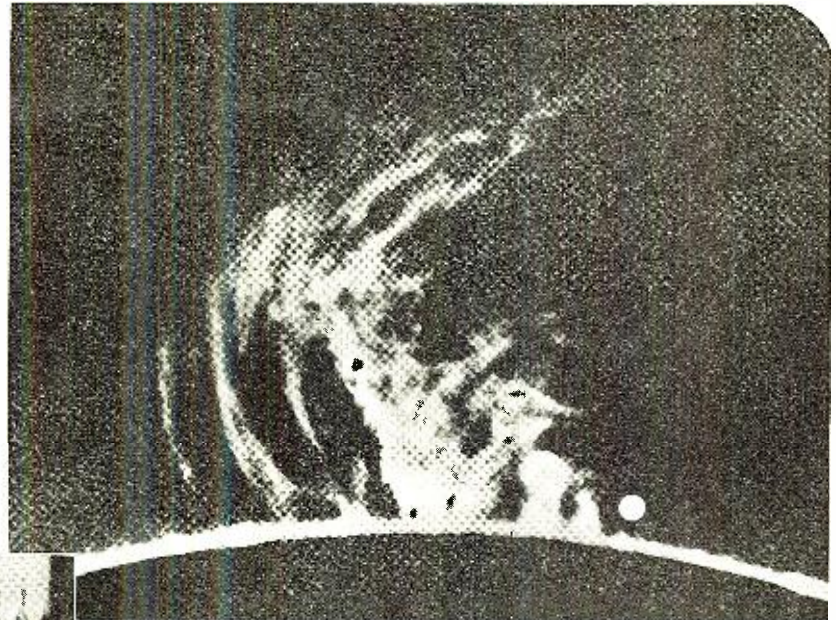

Photograph courtesy of Mt. Wilson Observatory



(Left) A display of "Northern Lights" which many observers have noted as having a direct bearing on radio reception. "The aurora has been explained as a great cloud of ions which can act as a radio screen; signals apparently reflecting back from it have been noted in England"

(Above) An eruptive prominence on the sun. This gigantic flame of calcium gas is about 140,000 miles high. The white disk represents the comparative size of the earth

kinds of solar radiation also affect general ionization and the height of the reflecting layer. The height and nature of this layer in turn profoundly influences radio transmission, as explained in our article in RADIO NEWS for February. The precise relations of cause and effect are imperfectly understood, but some of the practical results have been thoroughly charted.

A pioneer in this investigation is Pickard. He finds that broadcast reception recorded over long periods agrees closely with solar activity and magnetic activity. In general, increased solar activity (and more sunspots) means a decrease of night signals and some increase of day signals. As might be expected, the mean periods of signal variation are found to be 11.4 years, 15 months and 27 days, the last period marking successive earthward presentations of the same group. The 27-day interval of course changes phase when a new spot group arises in a different place on the sun. The day-to-day correlation of spot numbers and reception is very low, though it is much better if only spots in a central (earth-pointing) zone are counted. The meridian passage of a large spot group usually means: a magnetic storm reaching greatest intensity within one day and lasting one or two days; depressed night reception most marked after two days and lasting three or four days or more; slightly increased day reception over a similar period. Pickard finds that sometimes the effects may precede or follow the meridian passage of a group; in other words, the effects appear to come from ahead (west) of the spots or from behind them. On the long waves of 5,000 meters or more the effects are in the main similar, though night decreases may be less noticeable and day increases more noticeable.

The short-wave effects are complicated in the extreme, and the data available is insufficient. Here particu-

Sagging of the reflecting layer in an area of low atmospheric pressure. The lens-shaped sag of Kennelly-Heaviside may cause focusing effects, making better reception at certain stages of the low's passage

larly there seems to be an opportunity for the serious radio amateur. Pickard found some time ago that night short-wave reception increased during solar activity, but most observations indicate almost an opposite view. The present mean of opinion is that solar activity causes very low signal levels on short waves, both at night and in the daytime, with signals frequently disappearing completely. However, Maris and Hulbert find only daylight circuits affected during the early stages of a disturbance, and cite this as a proof that the true cause is an ultra-violet flash which heats and expands the upper atmosphere, causing the layer to rise. A great deal of research involving careful measurements is necessary before we can make many positive statements about the effect of solar disturbances on short waves.

Many observers have noted an apparent relation between the phase of the moon and radio reception. The general finding has been that reception is better at full moon, worse at new moon. Gravitation effects need scarcely be considered; but there are some possibilities in the idea that plane-polarized light, such as the moon reflects, may have an influence on radio waves. We advance the suggestion that, as the moon is roughly between the earth and the sun at new moon, it may have some effect on electron streams or other radiation coming from the sun. As the sun's rotation period nearly coincides with the lunar revolution period, however, it is probable that most supposed lunar effects can be traced to the sun.

**Weather and Radio Transmission**

Now we tread ever more warily among the fires of controversy. Some writers maintain that weather has no effect on radio; others say it is the greatest single factor. Some take pressure as the important element; others favor temperature. Reception and weather may be local (Continued on page 966)

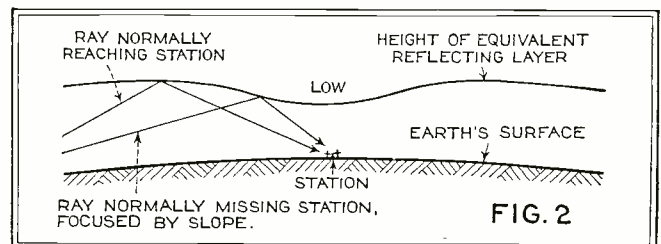



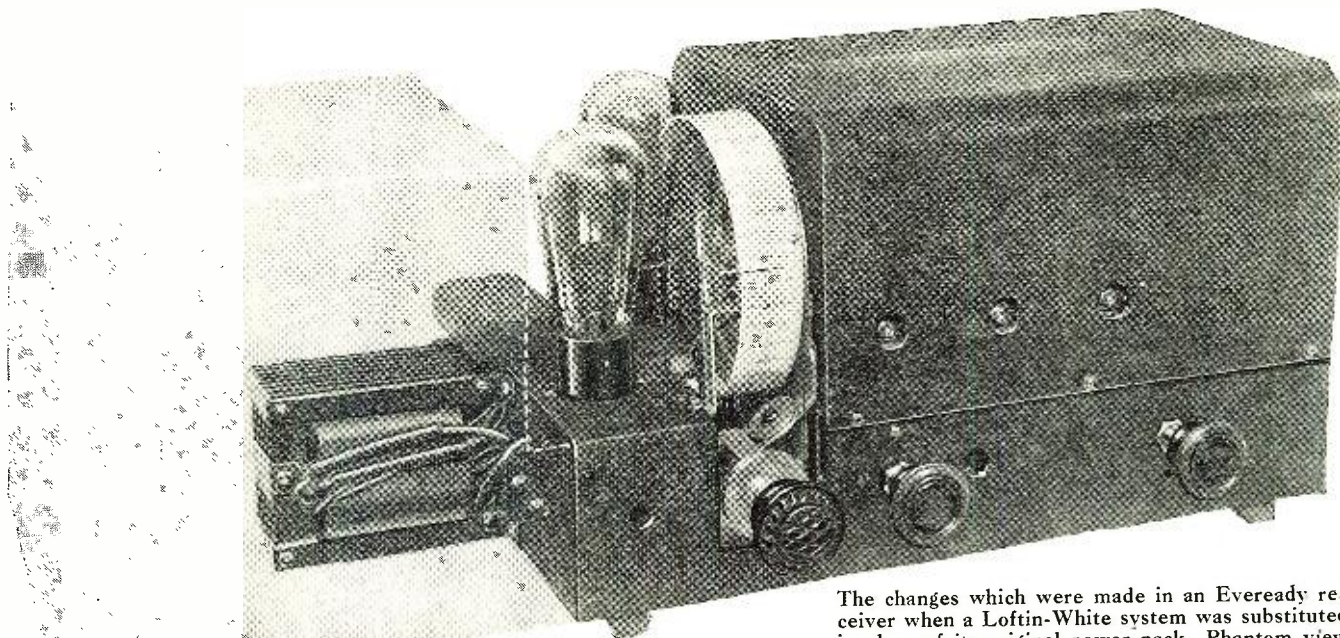

The changes which were made in an Eveready receiver when a Loftin-White system was substituted in place of its original power pack. Phantom view indicates the place occupied by power unit. In addition to the transformer, mounted at the end, the -45 tube in the forefront was added

# *Working the* Loftin-White

*Applying the new system to an already excellent receiver indicates the changes to be made as well as the manner in which any tuner may be employed*

By Commander E. H. Loftin and S. Young White

**D**EMANDS for additional data and requests for information as to how to include radio-frequency amplification again have interrupted our plan to proceed with theoretical and technical comments on direct-coupled systems. This article will tell how to substitute a two-tube direct-coupled system, using a -45 output tube, for the detector, two-stage audio amplifier and power unit of a standard broadcast receiver.

The consideration of detection at this time gives opportunity to correct a current erroneous impression that the direct-coupled cascaded tube systems which we have been describing are merely "amplifiers." The fact is that the extremely good and efficient amplification obtainable is only one of a number of capabilities of these systems. It is for this reason that we have made general reference to a "system" rather than to an "amplifier" in discussing direct coupling broadly.

Reference is first made to the wiring diagram of Fig. 1, inviting special attention to the exceptions to be pointed out later in detail. The system is exactly the same as the one described in our preceding article. The reference letters are the same as those used in the preceding article. This is intended to make it possible for those who may have constructed the pre-

viously outlined two-tube system to add radio-frequency amplification now, if they desire, without abandoning any of the apparatus acquired for the two-tube system.

We found the quality in the converted system to be decidedly improved over that of the original receiver—this in spite of the fact that the three stages of tuned screen-grid radio-frequency amplification were doing considerable side-band cutting for lack of broadness at the peaks, and we do not find that the elimination of push-pull has operated in any unsatisfactory manner. We did not need push-pull for hum elimination and suppression of generated harmonics, and we seem to have as much apparent output ability in the single -45 tube as was had in the original push-pull combination.

The hum, both modulation and direct, is practically inaudible in both cases, the original set having been extremely well filtered.

The tunable circuit TC is one addition, and includes a bypass condenser, C5, large enough not to affect greatly the capacity of the tuning condenser (not less than .02 microfarads) to avoid the effect of resistance R1a.

Any good radio frequency choke L1 and a condenser C4 of .0005 microfarads, connected as shown in the output of VT2,



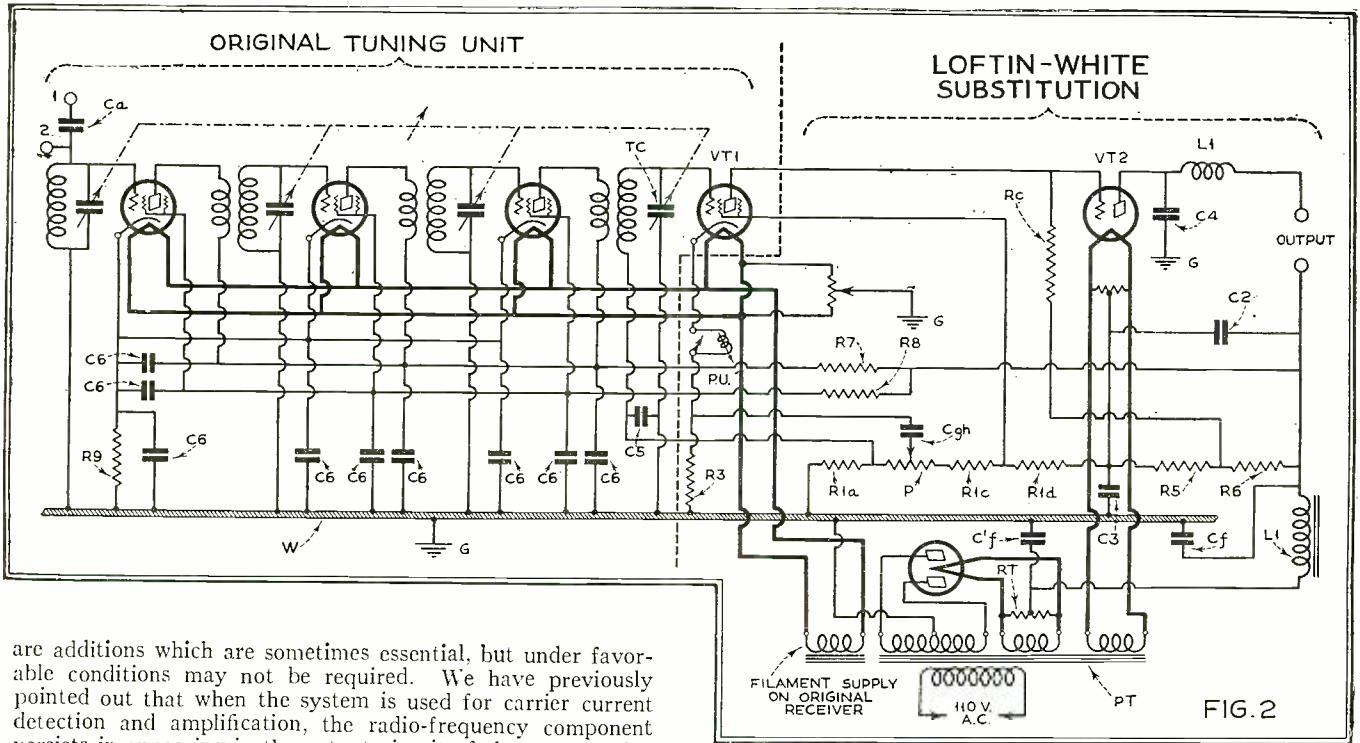

Diagram showing the changes which were made in a standard direct receiver in order to incorporate the Loftin-White direct-coupled amplifier system

are additions which are sometimes essential, but under favorable conditions may not be required. We have previously pointed out that when the system is used for carrier current detection and amplification, the radio-frequency component persists in appearing in the output circuit of the output tube. In other words, unless precaution is taken to prevent it, the output end of the system is alive with highly amplified radio-frequency energy.

The result of this fact is the possibility of a feed-back coupling between the antenna and some exposed part of the output system that is energized with radio-frequency currents that are sufficiently strong to cause oscillation. For example, in the case of the three-stage radio-frequency system preceding the two-tube direct-coupled system which we will later describe, there is enough coupling between the plate electrode of VT2 alone and the antenna in its usual connection to produce oscillation if VT2 is not shielded, or if nothing is done to reduce the radio-frequency potential in the output of VT2. Again, the coupling may be between exposed parts of some forms of dynamic speakers and the antenna, or between speaker leads and antenna. Reducing the matter to non-technical terms, if the antenna has a "clear view" of any part of the output system, troublesome regeneration is likely to occur.

Thus, under circumstances where the radio-frequency component in the output of VT2 has opportunity to cause a troublesome degree of feed-back, the radio-frequency choke L1 and condenser C4, connected as shown in Fig. 1, will reduce the radio-frequency potentials sufficiently to avoid trouble from this source, and no noticeable effect on operation results from the use of these elements.

The field coil of the dynamic speaker is used for the filter choke L, and is thus energized, and takes up a potential of 40 volts compared to the 10 volts in the filter choke L of our preceding article. This resulting loss of 30 volts in the filter output is not at all serious, the system not being critical to supply potential changes as previously stated. The loss can be partially compensated for by increasing the capacity of filter condenser Cf to 2 microfarads in order to increase the output of the -80 rectifier tube RT.

In Fig. 1 we show one way of making an addition of radio-frequency amplifiers to the system, and in Fig. 2 we extend the details to include the three stages of tuned, single-dial control, screen-grid radio-frequency amplification of the particular commercial receiver which we used.

In Fig. 1 V represents one or more tubes of a radio-frequency system having one or more tunable circuits TC1. The plate circuits of the radio-frequency tubes are energized from the filter through a potential-reducing resistance R7 of sufficient value to give the required current for all of the tubes, 25,000 ohms being the value we use for the three screen-grid tubes of Fig. 2. The value of R7 will of course be larger for a lesser number of radio-frequency tubes. The screen grids of the tubes are also energized from the filter through a resistance R8 of suitable (Continued on page 967)

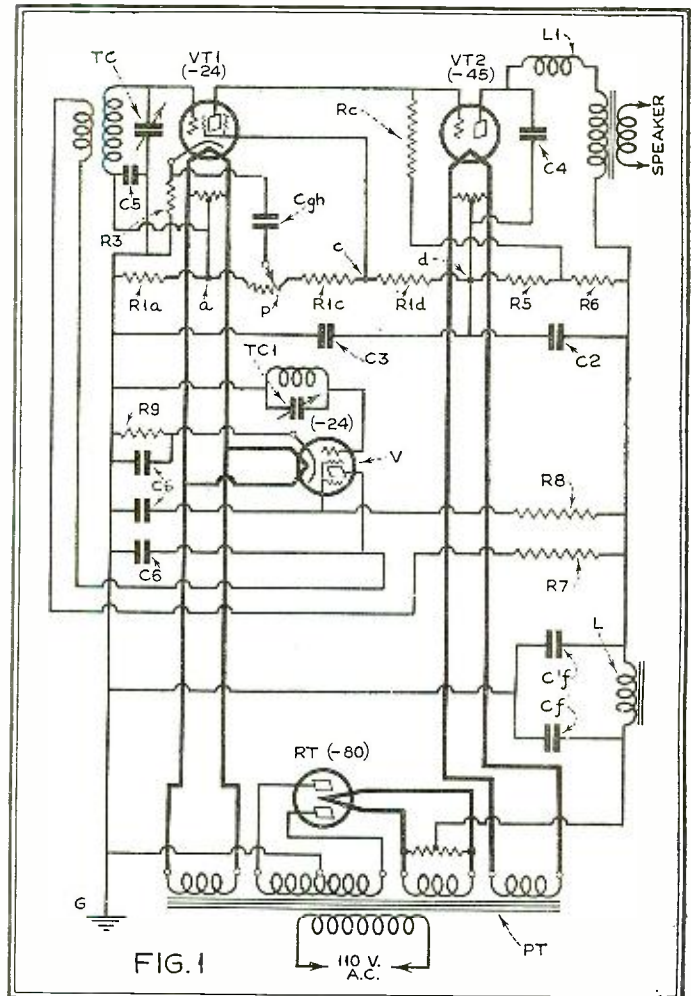

One method of adding two stages of radio frequency amplification to the Loftin-White system



# A TUBE *Every Second*

*Eveready Raytheon factory at Newton, Massachusetts, is now geared up to a production of 33,000 tubes every eight hours*

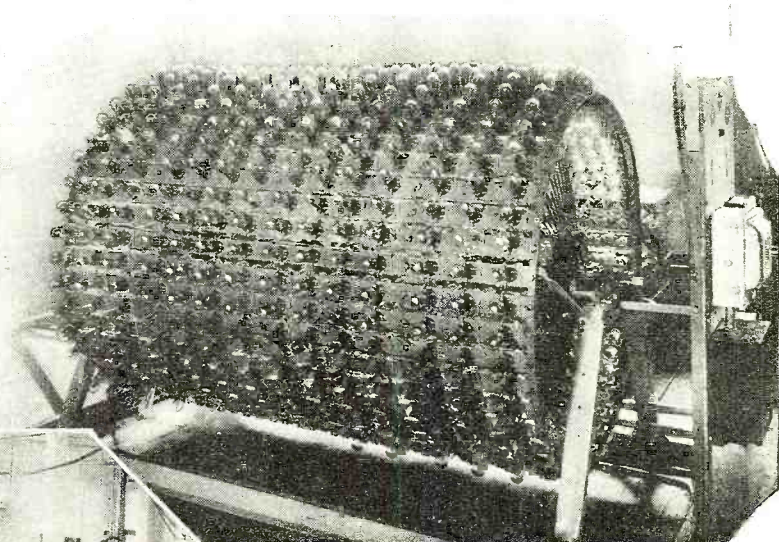

Above: A novel rotary machine, having a capacity of 600 tubes, in which the filaments are put through a process of activation. Left: Assembly tables in the factory. The highest order of precision is called for in the process of manufacture.

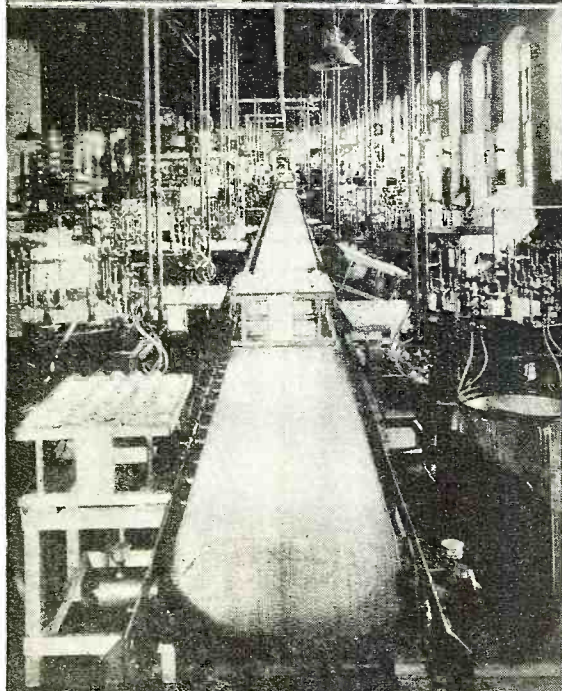
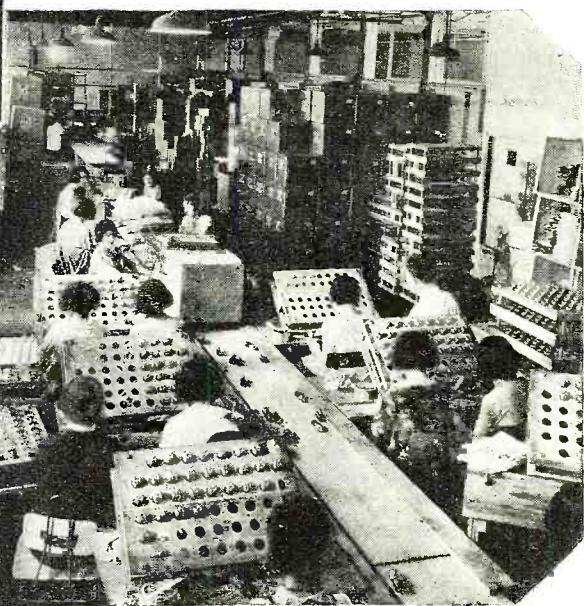
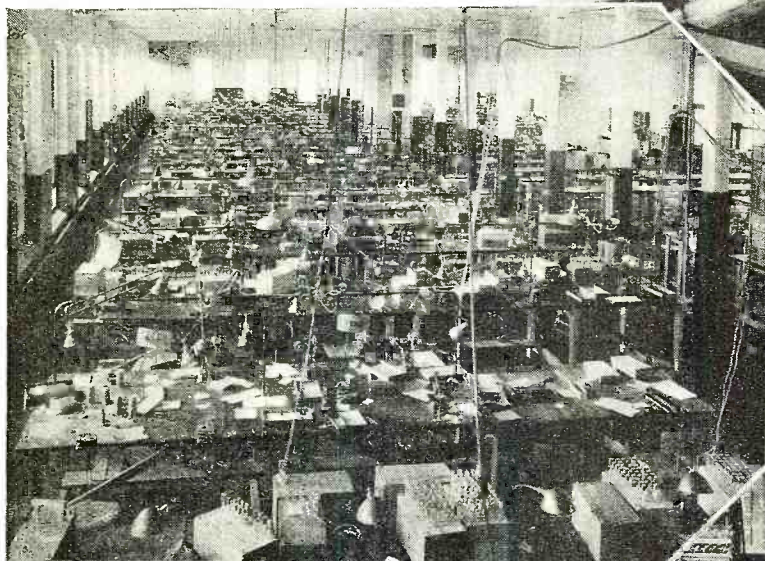

Two interior views of the factory, showing endless belts on which the tubes are conveyed from one testing station to another. Approximately five hundred minor inspections and two hundred minor tests are applied before the tubes are finally boxed for shipment.



# What of the Pentode?

*Unprecedented interest has been aroused by the announcement of a new five-element tube*

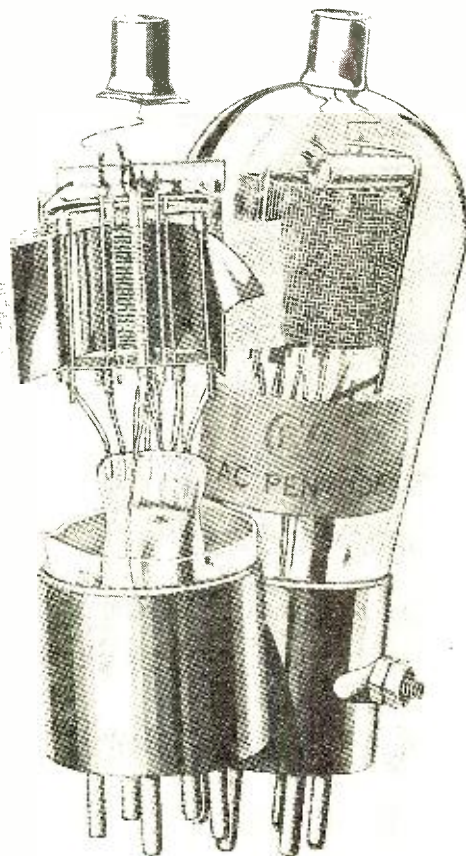

Two views of a pentode, or five-element, tube

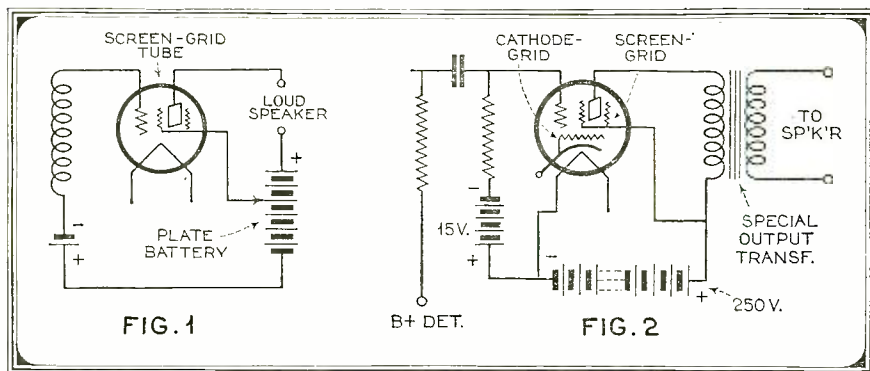

Fundamental circuits: Fig. 1, screen grid. Fig. 2, the pentode, resistance-coupled to the detector tube. The third grid is internally connected to the cathode

**EDITOR'S NOTE:** *This new tube is similar in many respects to the screen-grid type, except that it has an additional screen between the screen-grid and the plate. The insertion of this second screen, it is claimed, makes possible amplification several times greater than has heretofore been obtainable with the screen-grid type of tube.*

*The following viewpoints as expressed by three leading figures in the radio industry will shed some interesting light on this new subject:*

**By Ernest Kauer**

*President, CeCo Manufacturing Co.*

**T**HE public has been asking for receiving sets which employ fewer tubes. This new development makes it possible to build sets which will satisfy that demand. Bringing, as it is bound to, greater simplicity into radio receiver design, operation and maintenance, it will reduce manufacturing costs and therefore the cost to the consumer.

It will mean less tubes per family, but a great many more families will own receivers, and the probabilities are that tube sales will be greater than ever.

Summarizing, the principal features of the new pentode tube are as follows:

Three times as powerful as the screen-grid tube. Capable of being utilized to its fullest efficiency.

Cancels the necessity for multi-tube receivers.

Will lower manufacturing costs of sets.

Will decrease maintenance costs for set owners.

Thought savings possible, will enlarge the radio market.

**By Dr. Lee DeForest**

*DeForest Radio Company*

**T**HE air is filled with talk of the pentode, not the radio air, but that portion of the ether ruled over by Madame Rumor. Tracing the numerous rumors to their sources is most difficult. Suffice it to say that statements have appeared painting in glowing terms the features of the pentode, predicting for that tube a brilliant future, and for radio a startling improvement due to the latest vacuum tube. My own opinion is that such statements issue for the most part from the press bureaus of tube and set manufacturers who are looking for a new and revolutionary selling point. Improvements are not as radical nor as spectacular as formerly. The trade must do something about it. The pentode is the something.

The pentode is by no means new. As far back as 1915 I was working on such a five-element tube, and in 1916, 1917 and 1918 was granted patents on the pentode or circuits using such tubes. After the war I turned my attention to other matters pertaining to radio. The commercial demand was for the triode. More recently the screen-grid or four-element tube came into commercial existence. It was a vast improvement on the triode in many respects. Perhaps this fact has contributed to the belief that the pentode will be a similar improvement over the screen-grid.

Personally, I have grave doubts on the matter. True, the pentode has great undistorted (Continued on page 932)

**By George Lewis**

*Vice-President, Arcturus Radio Tube Co.*

**I**N the pentode we have something approaching the ideal vacuum tube wherein the maximum amount of plate power is controlled by a minimum amount of grid voltage fluctuation. It is a screen-grid tube adapted to power purposes for use in circuits where, with the four-element tube, the grid swing would be sufficient to introduce distortion through secondary emission.

Experimental models of the Arcturus pentodes indicate that a good commercial type will deliver about 2.5 watts of undistorted power output, dissipating about eight to ten watts on the plate, at a plate potential of 250 volts and with a grid swing not exceeding fifteen volts. Contrast this with the output of a -45 power tube which dissipates some eight watts and with a fifty-volt grid swing delivers 1.6 watts to the load or speaker circuit.

In other words, a good pentode, properly operated, will be about as effective as two -45 tubes in push-pull, for the same power employed (in power tubes) but possessing so high an amplification constant that it definitely eliminates the first audio stage, and probably, in many instances, will function both as detector and power amplifier, with obvious added economies. The elimination of previous stages automatically eliminates the hum and incidental distortion associated with the discarded tubes.

Fig. 1 shows a familiar fundamental screen-grid circuit. Fig. 2 shows a typical pentode (Continued on page 932)



# BUILD YOUR OWN

*Instructions for Assembling This Unique Kit Which Incorporates New and Distinctive Features and Is Adaptable to Any Car*

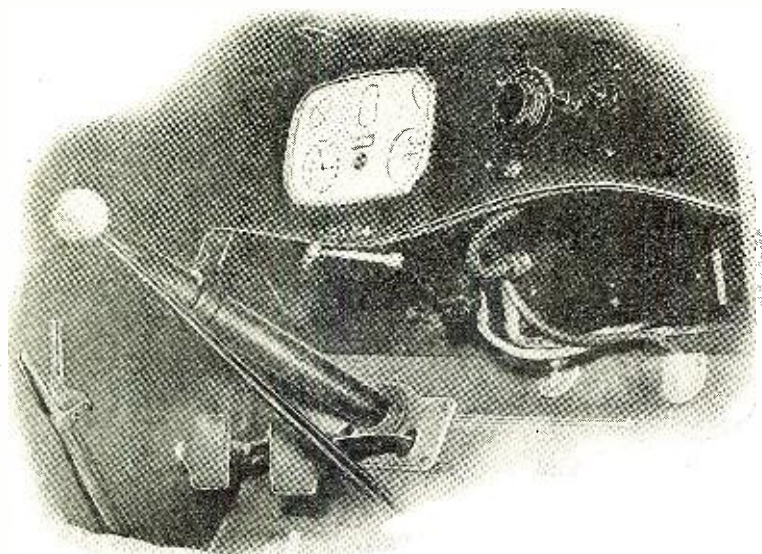

Tuning controls mounted on the dash operate the compactly built receiver conveniently located near the floor of the car

By Samuel Egert\*

WITH the coming of the new year a sudden demand for automobile radio receivers has broken through the surface of the radio market. This interest has grown through the general public's realization of the advantages of a radio set in an automobile. There is nothing as pleasant as hearing your favorite artist broadcasting over your favorite station, while you are covering many miles an hour. We still remember that first thrill of freshness that we got when we heard our radio set talking away in the car. It made the car seem alive. We tuned in WEAJ with enough force to break our ear-drums and buckle the window-panes. The tone was splendid, for the set was practically devoid of all ignition noises.

Next we tried tuning down the line for all the local stations. We met with great success, and we were mighty pleased with the results of our novel ride. We felt as though it was a good job finished. The small receiver took three whole months to develop. It was a matter of cut and try, add and try, cutting down on measurements, weight, method of control, and a hundred other small problems that insisted on some attention before they would succumb to reason.

This receiver offers the set builder a real article with which to work. Its ease of construction and installation and its method of tuning are striking examples of the rapid advance-

ments radio can make when a cry arises from the public; in fact, the competent engineers of the radio laboratories today are the minute men of the twentieth century.

Let us first consider the mechanical design of the receiver itself. As shown in one of the photographs, the set is completely encased in a metal box. This precaution was taken in order to prevent dust or any foreign substances, which might be picked up on the road, from entering the set and causing high resistance leakages, thereby diminishing the general efficiency of the receiver. All connections which must be made outside of the set protrude from the front of the metal box. There are pin jacks for loud speaker connections and a pin jack for the antenna. There are cables for the remote control which will be discussed later, and also cables for the battery connections. These cables are completely shielded. The shielding is a factor of the utmost importance for quiet operation. There is also a flexible shafting which extends to the

One coupling stage, three tuned r.f. stages and two audio stages are employed in this auto-radio receiver. Screen-grid tubes of the a.c. type, powered from a d.c. source, are used in the coupling stage, first and second tuned r.f. stages and in the first audio stage. Complete circuit details are shown below

\*Consulting Engineer, Continental Wireless Supply Corp.

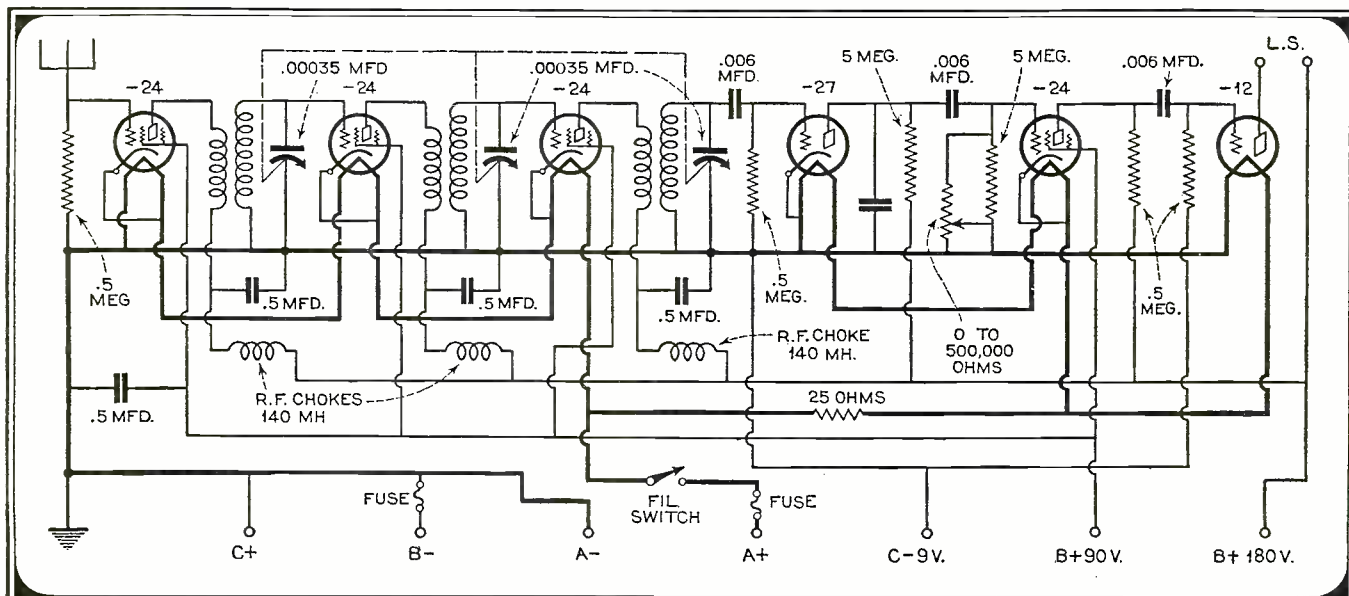



# AUTO RADIO RECEIVER

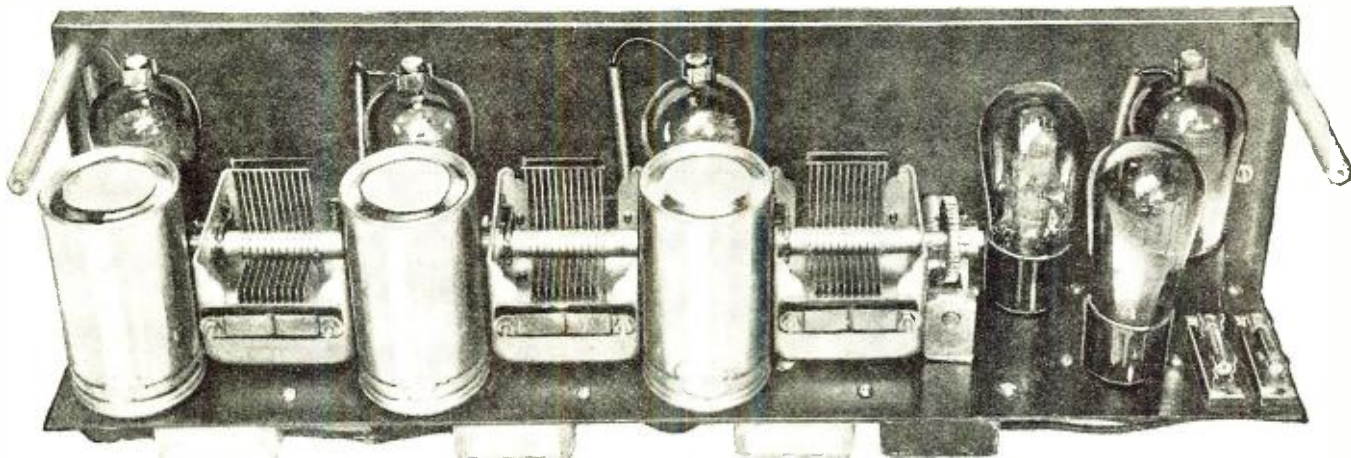

(Above) A rear view of the compact auto-radio receiver discloses the layout of the tubes, condensers and coil units

(Below) Here's the auto-radio receiver totally enclosed in a metal can, with its battery and flexible tuning cables and remote control ready for installation in the car

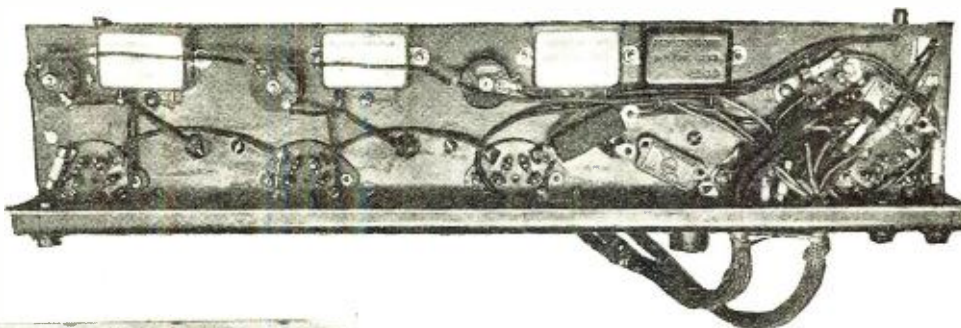

(Above) Below the metal sub-base are mounted the by-pass condensers and a complete resistance-coupled audio-frequency amplifier

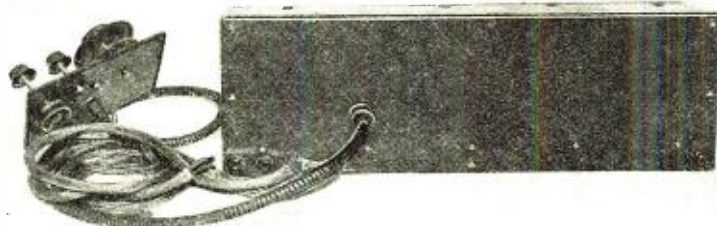

tuning knob on the dashboard. Next we remove the cover of the set, which is a strong steel shield. This is accomplished by means of removing only three screws which hold this metal cover to the main chassis by means of bolts screwed into the metal studs which are in turn mounted on the chassis.

Another photograph shows the neat and clean appearance of the receiver itself. The set immediately strikes the eye as being a factory-made job. Every inch of available space is used, while at the same time the parts are individually placed to assure an easy assembling and wiring job. Each stage is fixed so that the coil, condenser and socket are advantageously placed to obtain the shortest wiring leads possible. Aside from this, one can easily see how well one stage follows the other directly from the untuned stage of r.f. through the two tuned stages and the power detector, and finally into the two stages of resistance coupling. It can be seen that each coil stage is shielded by means of a neat, small metal can. The straight-line frequency condensers are of a fine, sturdy type in order to withstand the constant series of shocks which are impressed upon them by the jolting of the car. The sockets are of the manufacturers' type and are marked for their respective tubes, thereby adding to the general appearance of the set, and also avoiding error in the placement of the tubes in their respective sockets.

On the left side of the receiver, in the rear, are two fuses. These are extremely important and insure the wiring of the car. These fuses cover any defect which may arise in the wiring of the receiver. With this method, if there is a fault in the wiring of the set, the first thing that would break down

would be these fuses, whereas, if they were omitted, serious damage might result in the lighting or ignition lines of the car proper. A bottom view of the chassis shows the neat arrangement of parts.

The mounting and wiring of the receiver proper can be completed in two or three hours. The condensers and resistances used are small, but this does not in any way lessen their fine quality. Every part of the receiver has been selected for its quality, as well as for its usefulness. The chassis itself is constructed of steel. This ensures mechanical rigidity and takes away all fear which might be formed in the mind of the constructor as to its durability.

The length of the set is eighteen inches, the height six inches and the depth four inches. These dimensions are the smallest that could be obtained without hampering the mechanical and electrical design of the receiver.

The electrical design of the receiver presented no small problem. A receiver of extreme sensitivity was needed. This is necessary because most cars, being constructed of metal, act as a shield. This prevents the impressed signal voltage from getting to the aerial, which is usually placed on the inside of the car. Three stages of screen-grid radio-frequency amplification were chosen to obtain the desired sensitivity and the design completely swept aside any possibility of the use of suppressor resistors in the grid circuits. It therefore became necessary to choke and by-pass every possible place, in order to prevent stray radio-frequency currents from going where they should not go. The set is completely devoid of all oscillation if it is constructed exactly as shown in the diagrams.

Since it is necessary that we have only one tuning control, for the sake of simplicity we must obtain some method of coupling the antenna circuit so that a change in various lengths or types of antennae will have no effect on the tuning. There are two methods whereby this may be done. One is that of



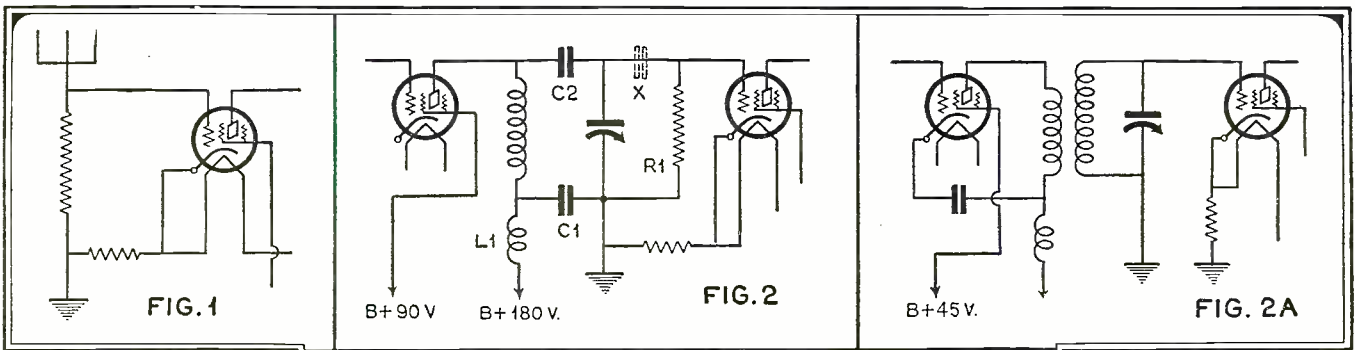

Fig. 1, circuit for coupling antenna to first r.f. stage. Fig. 2, impedance coupling circuit between r.f. stages, illustrating method of isolating plate potential from tuning condenser. Fig. 2A, a standard transformer-coupled r.f. circuit, finally employed

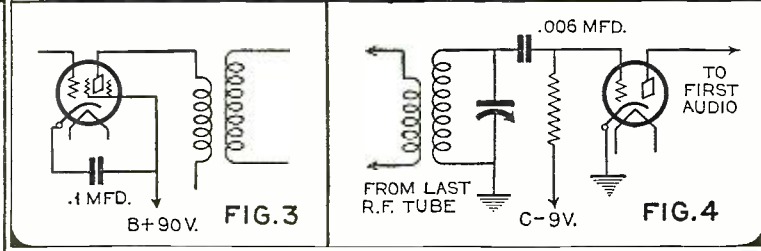

Fig. 3—The transformer-coupled r.f. circuit, employing only by-pass condensers in the screen-grid circuits. Sufficient stability was obtained to make unnecessary the inclusion of r.f. chokes. Fig. 4—Circuit details of the power detector stage

using a resistance in an untuned stage of radio frequency, as shown in Fig. 1, and another is the use of a choke that would replace the resistor as it is shown in Fig. 1. Both methods are equally effective. The resistance was chosen because it is the easier to connect in the circuit and because it takes up less space, an important factor.

In choosing the method of coupling between the stages of radio frequency, we first considered the impedance method shown in Fig. 2. This method necessitates the inserting of condensers C and C2 as they are shown in Fig. 2. These condensers prevent the plate current from entering into the tuning circuit of the radio-frequency stage. The condenser C2 may have been placed at position X, but by doing this we should have impressed a "B" voltage on the stator plates which would have made the latter "alive." If the condenser were to short circuit, the "B" batteries might easily be ruined. In order to obtain a grid bias on the grid of the radio-frequency stage, a resistor R1 must be placed in the circuit, as shown in Fig. 2. The choke coil L1 is inserted in the circuit in order to keep the high-frequency signal out of the "B" batteries, where it would probably feed into a preceding stage, causing the circuit to oscillate.

It can easily be seen that this means a plurality of by-passes and resistances, aside from adding to the weight and difficulty of wiring. The condensers and resistances always have high-frequency fields around them, making it almost impossible to shield the circuits. All this results in a highly critical set unsuited for anything but a laboratory. It was for this reason that we chose the transformer method, shown in Fig. 2A, as being the more sensitive, dependable and efficient.

It was not found necessary to place choke coils in the screen-grid leads to prevent oscillation, because the set is perfectly stable without anything more than a 1/10 microfarad condenser across the screen-grid supply line as indicated in Fig. 3.

The radio-frequency plate leads must be choked in order to prevent oscillation. This is done with a 140-millihenry choke coil in each battery lead to the radio-frequency coil, as shown in Fig. 2.

The next problem which confronts us is the type of detector that should be employed. The question here lies between the power detector and grid-leak-condenser arrangement. The power detector shown in Fig. 4 is far more suitable for our purpose than the grid-leak type. This is because it becomes necessary for our detector to handle the great gain which is built up in the three stages of screen-grid radio-fre-

quency amplification. The condenser and leak arrangement would overload if it was called upon to handle this gain. This in turn would cause the set to distort, giving a poor quality of reproduction in the speaker. The power detector will handle this great gain without distortion, and therefore becomes fixed in place. The DeForest 427 is chosen and it fits admirably in its place. The next problem was the choice of an audio system. Resistance-coupled amplification was chosen in this case. Resistance-coupled audio amplification will give us as faithful reproduction as the best designed audio-frequency transformer. The resistances are much lighter than the transformers. This fact alone is enough for us to appreciate the advantage of a resistance-coupled amplifier in the set. The resistances are tucked in nicely underneath the panel, shortening the leads considerably and facilitating the wiring to a great degree. A -24 screen-grid tube is employed in the first stage of the audio. This tube produces a high gain on an audio-frequency signal. A -12 is employed in the last stage.

As mentioned before, each part of the receiver was treated carefully, taking into account all the advantages and disadvantages, in reference to dependability, quality of reproduction and ease of assembly.

Finishing our electrical discussion, we arrive at the following conclusion:

The antenna feeds into a -24 tube through a 500,000-ohm resistance. The -24 tube feeds into a tuned transformer stage, supplying a second tuned transformer -24 stage, which in turn feeds the power detector 427 stage. The detector tube works into a -24 as a first audio, thence into a -12 as a power amplifier. The three radio-frequency tubes are connected in series across the 6-volt A battery. While this means that the tubes operate on but 2 volts each, that is all that is necessary to make them function with full efficiency. The detector is in series with the first audio tube and also with a 1/4-ohm resistance. This will allow 2 1/2 volts on both the detector and first audio. The output tube is connected across the low side of the 1/4-ohm

filament resistor, and therefore has 5 volts impressed on its filament.

A remote control which is very easy to put together has been designed for the constructor. It employs a flexible shafting which extends from the receiver to the control on the dashboard. At the receiver end a worm meshes with a flat gear giving a gear ratio of 50 to 1. On the control panel at the dashboard a compound system of gears, of a 50 to 1 ratio, reverses the vernier motion on the (Continued on page 965)

Below are shown the knock-down remote tuning and volume control mechanism and the flexible coupling shaft

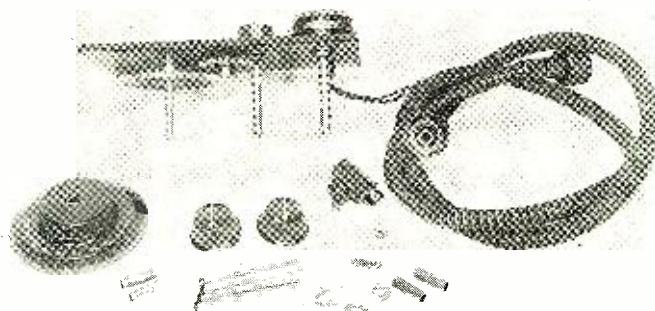



# Amos

'n'

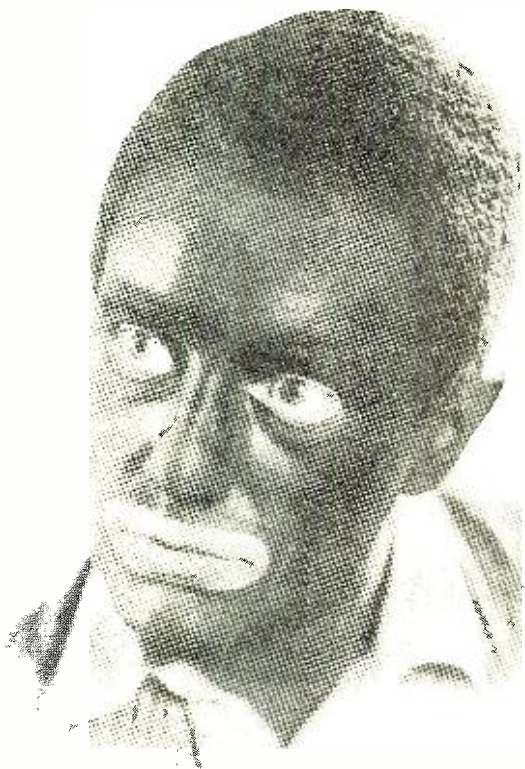

# Andy

Being the Biographies of  
Two Bumptious Black-  
faced Broadcasters who  
Bring Bliss to Billions

By H. P. W. Dixon

**A**MOS 'n' Andy are two of the best known radio characters in America, and in the last six months—the time they have been on the National Broadcasting Company networks—they have made radio history in broadcasting at least 150 times, which is the equivalent of three years on the air for an ordinary weekly program.

The story of the program can be told in a paragraph. Amos 'n' Andy, two colored men, operate the Open Air Taxicab Company in Harlem. Each night a microphone picks up the highlights of their day as revealed in their discussions with their associates. Their business ventures, their amusements, even their affairs of the heart, are told in their conversations. The story goes on and on, and it has been asserted that if you listen in three nights in succession, you'll be an Amos 'n' Andy fan. The program is the first daily "comic strip" on the air.

Another paragraph will give all that is necessary of the history of the originators of Amos 'n' Andy. They are, in very private life, Freeman F. Gosden and Charles J. Correll. Gosden is Amos and Correll is Andy. Correll was born in Peoria, Illinois, and grew up with the ambition to become an actor. Gosden, a native of Virginia, was an actor when the

two men met in North Carolina almost eight years ago. They became partners and for a while traveled about staging amateur revues for Junior Leagues and other organizations. Then they teamed together in a theatrical company. In 1925 they appeared for the first time before the microphone. In 1926 they introduced "Sam 'n' Henry" to the radio audience. Two years later they created "Amos 'n' Andy," popularizing them throughout the Middle West. In 1929, the N. B. C., on the lookout for outstanding radio talent, signed them up and subsequently put them on the air under the sponsorship of the makers of Pepsodent toothpaste.

Not even the sponsors realized how popular they were until a strange thing happened. When Amos 'n' Andy changed from the Columbia Broadcasting System to the N. B. C. network, their program was scheduled for 11:00 o'clock, Eastern Standard Time. Parents and children protested. It was too late for the youngsters, and the youngsters who were Amos 'n' Andy fans were numbered in hundreds of thousands.

It was then arranged to present the pair at 7:00 o'clock in the evening (Eastern Standard Time), in order that youngsters might listen in. Then the squall broke. (Cont'd on page 951)



# Radio Becomes a "ALKIE" "PROP"

*The filming of some stupendous feature pictures would have been impossible without the connecting link of short-wave radio*

By Don Bennett\*

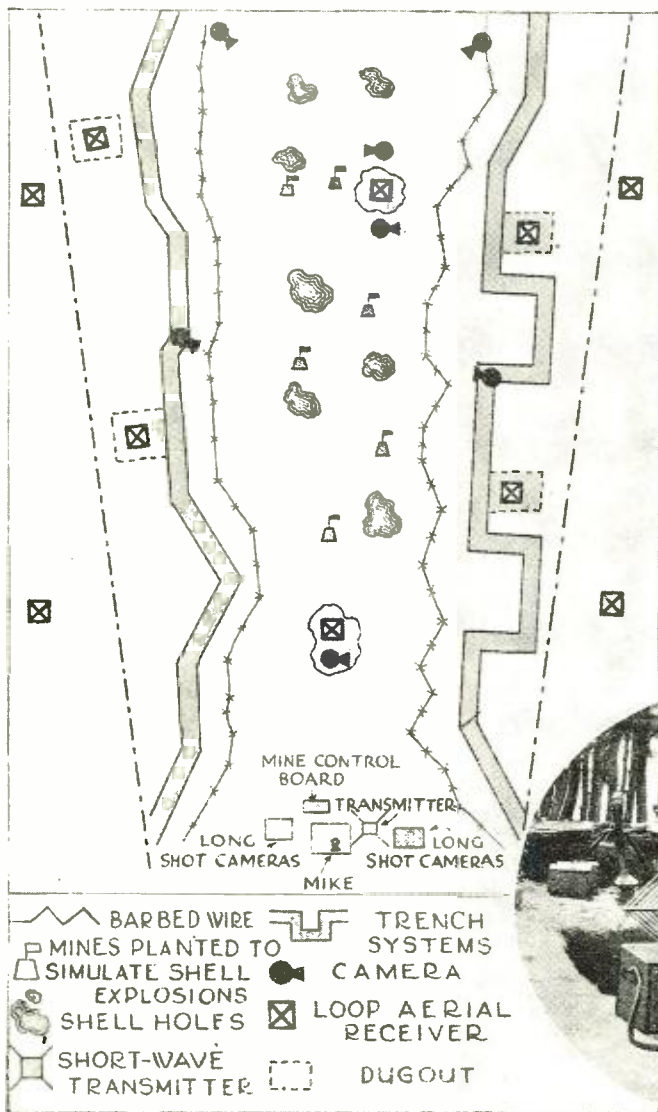

IT is a good many years since David Wark Griffith made "The Birth of a Nation." And it is only a few years since radio became popular. Few would associate the two, but the fact remains that Griffith used radio in directing the large battle scenes in this first of great motion pictures. The technique involved was the same as that employed by present-day directors of large motion pictures, but of course the speed with which Griffith's messages were relayed to his assistants at different points of the battle-field was much less because code transmission was employed, voice transmission at that time being only a laboratory toy. A man who assisted Griffith on that picture assures me that the handling of those large scenes would have been almost impossible without radio. Continuous rehearsals of the thousands of extras would have been necessary, production would have been slowed down, costs would have been greatly increased.

There is no record of radio being used during the intervening years up to 1926, when we find Victor Fleming using short-wave voice transmission to handle the big scenes in "The Rough Riders." If you recall this picture you will remember the sequence where a landing is being made in small boats from the transports a mile or more off-shore. The distance was too great for the human voice to cover, and the sea pre-

vented the stringing of telephone wires. Hence, short wave radio was enlisted in the work of directing, and a low-power short wave voice transmitter was constructed along with the required number of portable receivers. The transmitter was set up on a high point overlooking the beach, and receivers were scattered wherever needed: several on the beach, hidden behind bushes and shacks, several in the boats making the landing and on the transports to give the proper cue for the boats to start shoreward. Assistant directors were stationed at each receiver to relay the instructions and to direct particular phases of the activities. Telephone lines were strung to the cameras on shore, since they were in a fixed location and the wires would not appear in the scene. Radio also was used in some of the battle sequences at the storming of San Juan Hill, for handling the more distant forces. Radio had

Photos by Columbia Pictures

How portable radio receivers are distributed to control movements of large groups in a battle scene. The insert shows a dugout with camera and portable radio receiver used in the filming of a scene from "Flight"

\*Chief Technician, Stanley Film Adv. Co.



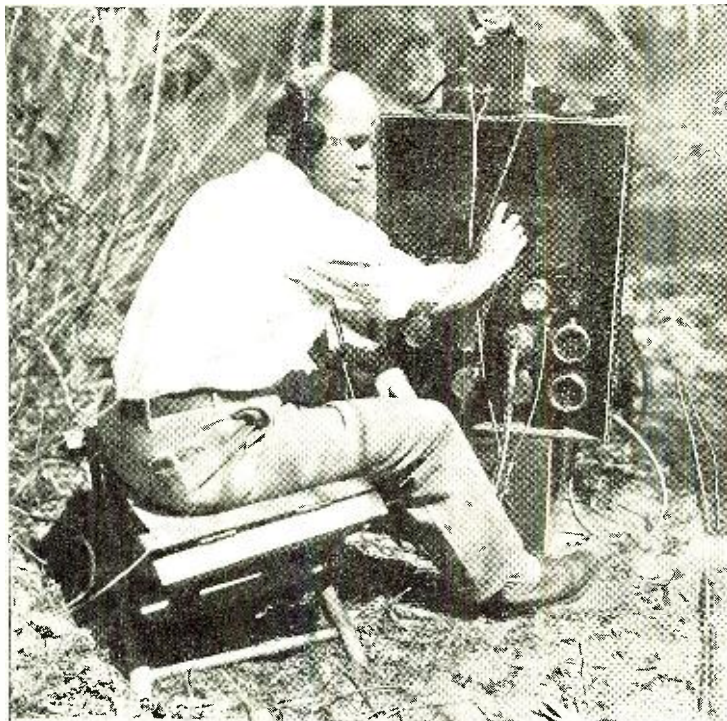

Field mixing panel where the pick-up from the various "mikes" is adjusted to the proper level before being passed along to the recording equipment housed in the truck. The voice signals from planes flying overhead are added to the ground noise before being fed into the recorder

the advantage over telephone lines of rapid change of scene. A portable radio receiver could be picked up and carried from place to place, whereas a telephone required the moving and laying of wires.

Jimmy Cruze was the next director to use radio when he made "Old Ironsides," a picture glorifying our early navy. The big scene in that picture was the attack on the fortifications by the "Constitution" and the accompanying dhows. The movement of all these vessels was governed entirely by radio. Radio again saved thousands of dollars by giving Cruze complete control at all times over the various units, and obviating the necessity of repeating these big scenes because someone timed their action wrong or went to the wrong place. As in "Rough Riders," a transmitter was set up near the director, and portable receivers were used on each of the vessels and in the castle on shore. As an example of the value of radio in regulating the effect, consider the cannonading in this scene. It was necessary for certain spars and masts on "Old Ironsides" to be shot away. It is almost impossible to time such things beforehand; there is an exact instant when these incidents should happen. It is that elusive thing known on the stage as "timing." The whole effect of an action or scene can be spoiled by incorrect timing. In motion pictures the director controls the timing of each of these little incidents in such a way that the effect of the whole sequence is smooth and harmonious, each incident fitting in with the others perfectly. Unless the director can himself control and judge during the filming of this timing, his hands are tied. Hence, in "Old Ironsides," when Cruze felt it necessary for the fore-to'-gallant mast to drop as a result of the cannon fire from the castle, he simply spoke into a microphone, and the mast, a thousand feet away, was released, and fell just as if an actual shell had struck it.

"Wings" was the next "big" picture to use radio. Here we went into a third element, the air, where rapid movement is the order of the minute. Radio was the only means of controlling these fast moving ships so essential to the story. In the battle scenes on the ground, planes were crisscrossing

overhead continually, observing, bombing and harassing with machine-gun fire. Their action had to be controlled. On the ground far-flung units covering more than five square miles needed to be unified in movement. Giant trumpet horns controlled those in the foreground—within a few hundred yards of the camera tower. Radio controlled those in the air and the ones farthest from the cameras. Radio started the planes from the flying field a few miles away so that they arrived on the scene of action at just the right moment; it told the stunt pilots just when they were to fall in flames; it held back the company that was creeping ahead of the line; it speeded up the retreat of the enemy. Film footage controlled this battle. Too slow movement means too much film, and a scene that is costing several hundred dollars every time the camera turns, must be made over. And a small box with a few dollars' worth of wire and aluminum and glass in it is the master of the situation, relaying the director's crisp commands in a fraction of a second. Wellman, who directed "Wings" and its sister picture,

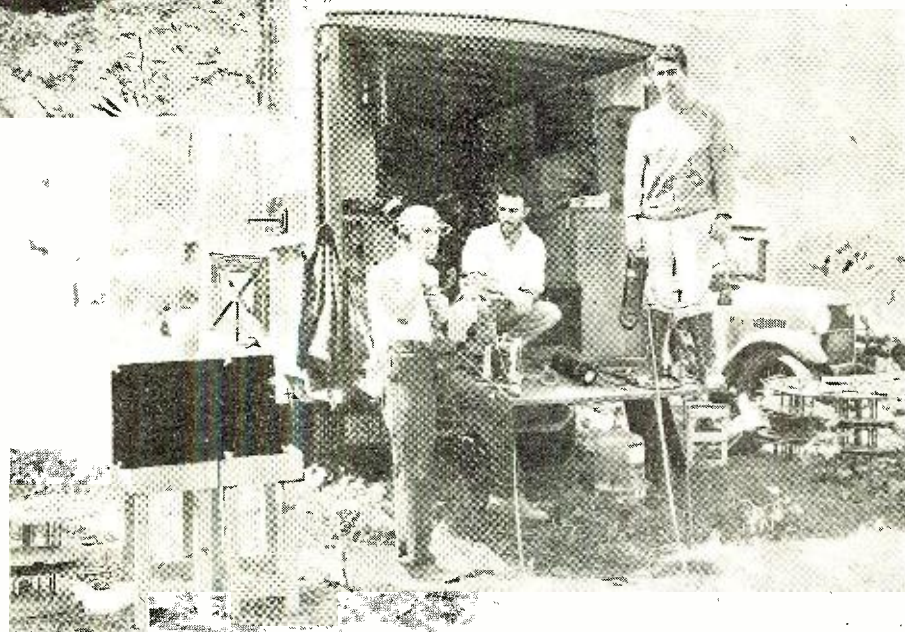

"The Legion of the Condemned," feels that radio is his greatest aid in handling these large scenes.

So does Frank Capra, who directed "Submarine" and "Flight." He used radio in making some of the scenes in "Submarine" but first found its true value when he filmed "Flight." He says: "Radio is an indispensable aid in the direction of pictures where the scene of action takes place over a large territory, or thousands of feet in the air."

In making "Flight," Capra had the full cooperation of the Marine Corps flying base at San Diego. The Marine Corps loaned him a radio truck equipped with transmitters and receivers, which he used to communicate with the air base forty miles away (there was no telephone within ten miles of the location), and with the planes in flight during the filming of the picture. The flying field at the location was too small to take care of the large fleet of planes used in the picture, and the ships worked almost entirely from the Marine Corps base. When preparations were complete for shooting, they were ordered into the air and, upon arriving over the scene of action, their movement was controlled to blend with the action on the ground.

Several new things were accomplished through the use of radio in this picture. For the first time recording was accomplished by radio from an airplane. Carefully adjusted cameras were installed on the planes and the principal actors wore a special type of microphone into the air with them. You are no doubt familiar with the fact that if you hold a telephone transmitter against your throat or chest, the listener at the





Victor Fleming, Paramount's director, uses short-wave radio to direct the big landing scene in "Rough Riders." Co-ordination of the movements of the small boats was effected by using loop receivers placed in key boats of each group of boats to pick up Fleming's orders

A short-wave transmitter placed near the director and cameras conveyed Fleming's orders for the movement of the attacking party to each boat

other end can hear you as clearly as if you spoke into the mouthpiece. This was taken advantage of and special small microphones were fastened to the throats of the actors, being covered with scarves so that they would not show in the picture. The regular phone transmitter with which all Marine planes are equipped was used to transmit to the ground, where the portable receiver picked up the signals and fed them into the recording apparatus. The use of the throat type microphone prevented engine noises from intruding on the voice, but in order to add realism and give the proper background to the voice, a certain amount of noise was introduced at the recording end. Jack Holt, the leading actor in this film, is a licensed pilot and the only thing new to him in the making of the picture was the use of radio.

Capra also used radio for directing the ground units in this film. The story calls for an attack by natives on a group of Marines. The Marines were sheltered by a log wall which, during the fighting, is surrounded by the natives. Capra was far in the background where he could obtain a general view of the scene, the natives, the compound sheltering the Marines, and finally the planes that arrived in the nick of time to shelter the beleaguered sea-soldiers. Twelve hundred feet above the scene of action, on a mountain peak, were several cameras getting a bird's-eye view. Each unit had portable receivers scattered around, with an assistant director listening in. Loud speakers were out of the question, as the sensitive microphones would pick up the director's voice. Radio was the only medium that made it possible for Capra to handle all of the units in a smooth way.

Radio has enjoyed another novel use in motion picture production, that of enabling production units thousands of miles away from the home studio to keep in constant communication with home. When "White Shadows in the South Seas" was being filmed in the Marquesan Islands, five thousand miles from Hollywood, W. S. Van Dyke, the director, was in constant communication with the home studio, reporting progress, ordering supplies—as near, through radio, as though he were just a telephone call away. Nearer, in fact—and there were no wrong numbers. The amateur station 6BZ.N handled the California end of the hook-up at Culver City. Van Dyke took radio with him to Africa when he filmed the "natural" shots of "Trader Horn." He says: "Short-wave radio was of invaluable assistance to me while making 'White Shadows' and 'Trader Horn.' Through its use we were enabled to keep in direct touch with the home studio although we were thousands

of miles away. A telephone could not have been more convenient. While making 'Trader Horn' we were constantly on the move and short-wave equipment, compact and easily portable, was the only solution to our communications problem."

The equipment for this expedition was built by Ralph Heintz, who also built the sets carried by the "Southern Cross" on her trans-Pacific flight, and by Wilkins on his trip to the South Pole. Clyde Da Vinna, W6OJ, was operator of the expedition's radio equipment, as well as chief cameraman. While in Africa he operated under the call of FK6CR. Upon his recent return to America he related several amusing and interesting stories of the trip. At Murchison Falls in Uganda, soon after pitching camp, the unit was visited by a cloudburst. As the transmitter had just been set up, it was treated to a most thorough washing, which called for several hours' patient work before it was dry enough to operate. One evening, while



Photos by Paramount Pictures

"CQ-ing," he was answered by WFA (the Byrd Antarctic Expedition). He gave his location and was told to stand by. A few minutes later a message came from Joe Ganald, addressed to his parents, who were traveling in Uganda. Da Vinna accepted the message, and it was forwarded by native runner, who returned next day with an answer. South Pole to Uganda and return, two days!



Old Ironsides was also equipped with a short-wave receiver which picked up the signal to drop the upper spars and masts to give the effect of their having been shot away. Only through the use of radio could perfect timing been possible



It is highly probable that radio has been put to more unique uses in connection with the production of motion pictures than we have been able to show in this article. Since Griffith produced "The Birth of a Nation" radio has made rapid strides. While an exact record of the equipment he used is not available we can assume that it consisted of a large aerial erected on high poles near his directing stand. Large helices, unknown in this day of small parts, formed his transmitting inductances, and a huge "coffin" transformer supplied the thousands of volts necessary for the old spark "rock-crusher." The receiving stations required clever work to conceal the antennae, because in those days the rule was, the more wire in the air, the more stations you copy. The re-

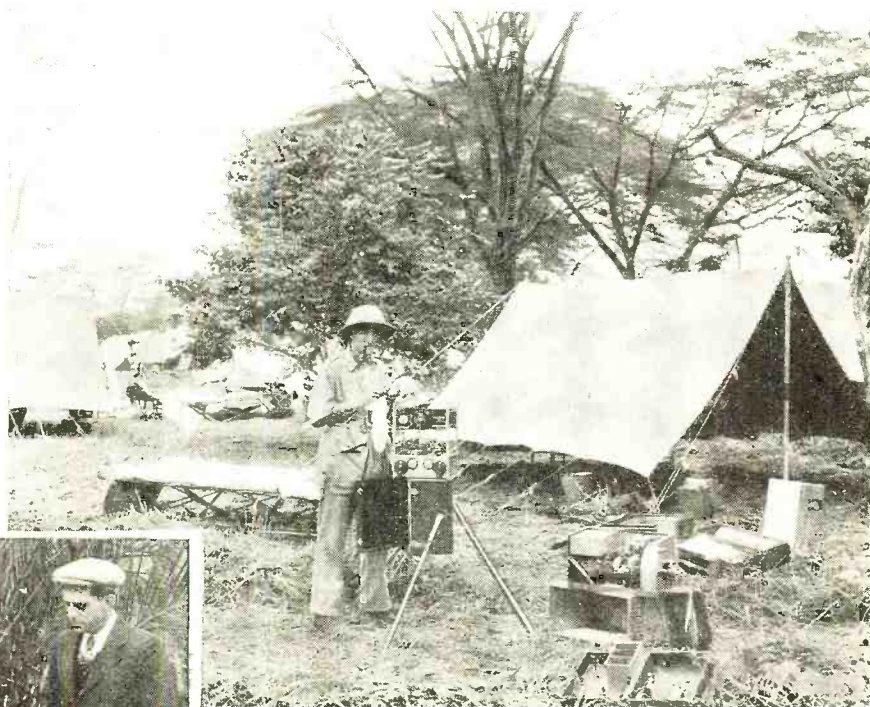

Photo by M-G-M

Above: Clyde DeVinna, W6OJ, drying his short-wave equipment after a cloudburst in Uganda, Africa. Generator set, foreground right, supplied high voltages to the transmitter. This equipment operated in Africa under the call FK6CR

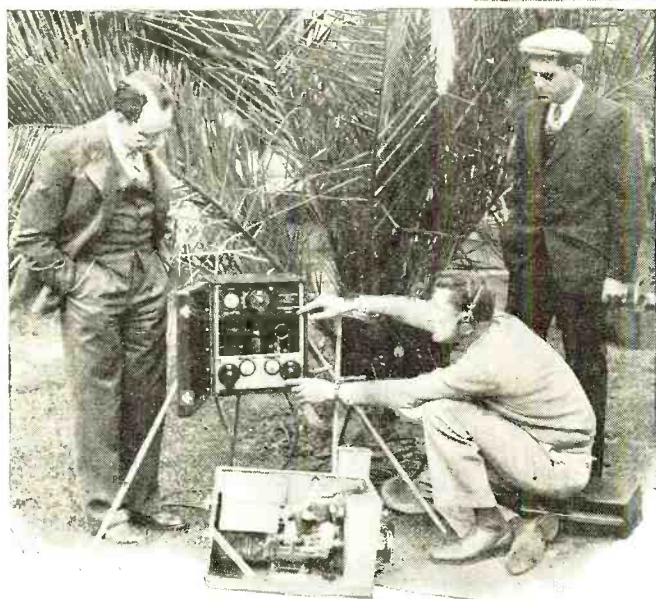

Photo by M-G-M

Left: Clyde DeVinna and W. S. Van Dyk, chief cameraman and director, respectively, inspecting the portable short-wave transmitter and receiver which they carried with them in Africa

ceiving operator had to copy the message in it's code form, write it out and send it to the assistant director resulting in a delay of minutes before the director's instructions had reached the point where they could be executed.

It is really too soon to tell what will result from Capra's experiments in recording by means of radio. Unlimited possibilities open before us in applications of these principles. We all know that "Flight"

was enjoyed by everyone who saw it, which is proof that his experiments were successful, and it may be that from this will develop the idea of central recording points for location recording. At the present time, recording within the studio is handled in a central location, wires running to the various stages connecting them to the recorders. Is it too far-fetched to assume that companies on locations within several hundred miles of the studio will not carry recording equipment with them but will rely on short-wave radio with a synchronizing

note on another wave, such as is used in some systems of facsimile transmission?

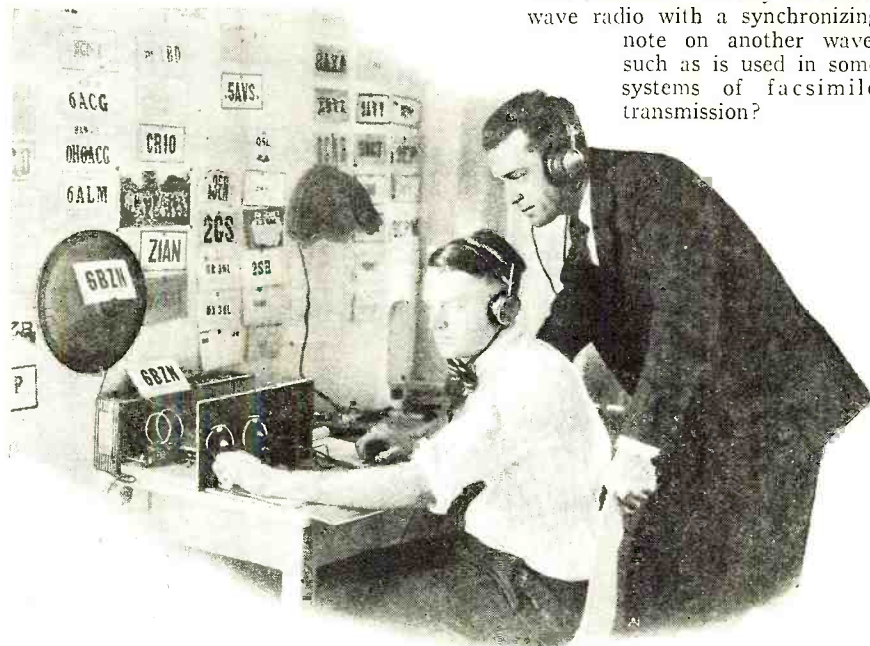

Above: W. S. Van Dyk, director, inspects the station of George Bandbridge, 6BZM, which kept him in touch with his studio in Hollywood while filming "Shadows" 5,000 miles away in the Marquesas Islands

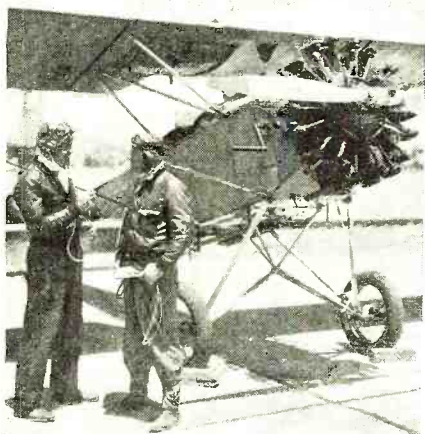

Photo by M-G-M

Left: Underneath the mufflers worn by the flyers are special throat microphones which pick up their voices, excluding the roar of the motors



# Eliminating the

By

Benjamin F. Miessner

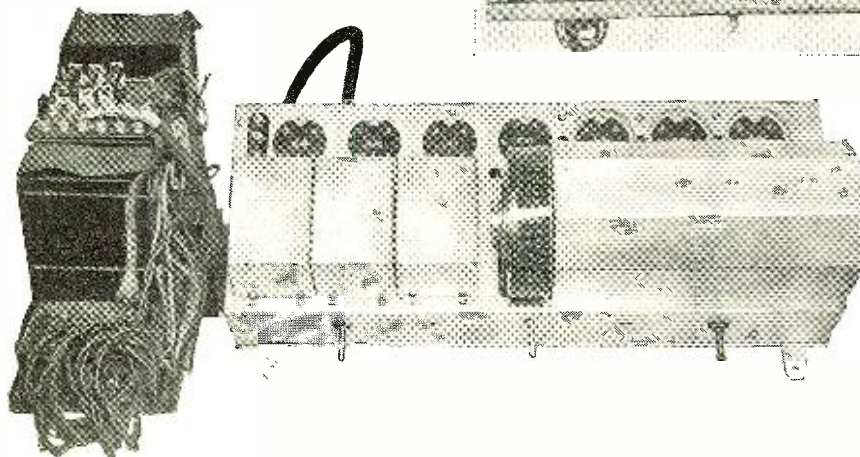

(Left)—A standard manufactured chassis with its power pack at the left. (Above)—Underside view of the same chassis after the entire original power pack had been eliminated. The two black boxes contain all of the apparatus required—utilizing the Miessner system — to give even better performance

**I**N my last instalment of this series, appearing in the April number of RADIO NEWS, the evolution of the a.c. powered, B-C supply system from the old "brute-force" type to the more modern types was described.

The first step in this evolution, characteristic of the old B-C eliminator antedating the self-contained electric sets, completed the filtering equally for all tubes, before division of the total output voltage into the various portions required for B and C voltages of the different tubes.

The second step differed from the first only in that each tube or group of similarly operated tubes, such as the radio-frequency and first audio-frequency group, produced its own bias by the flow of its plate current in a bias resistor.

The astonishing thing about these circuits is the wastefulness of filter apparatus. In the first place, the current for the power tube or tubes, taking from one-half to three-fourths of the total rectified current, is filtered just as well as that for the detector tube, notwithstanding the fact that the detector current requires from one hundred to five hundred times the filtering because of the succeeding amplification or, to put it in another way, if the detector current is filtered sufficiently well to eliminate its hum, then the power tube current has been filtered from one hundred to five hundred times too well!

Viewed from another angle, our astonishment grows apace. In a modern set with -45 power tubes in push-pull, the total

load may be 100 milliamperes, of which the -45's take about 60 milliamperes, the radio-frequency and first audio-frequency tubes about 18 milliamperes, the detector tube only 2 milliamperes, and the voltage divider about 20 milliamperes. Here only two per cent. of the total load requires a high degree of filtering, eighteen per cent. a medium degree and sixty per cent. a low degree, whereas the twenty per cent. taken by the voltage divider really requires none, since it is wasted. Here ninety-eight per cent. of the current is filtered to the very high degree required by the detector's two per cent. when it need only be 1/200th as good! And the eighty per cent. taken by power tubes and loss resistor is filtered as well as the eighteen per cent. taken by radio-frequency and first audio-frequency tubes, when it need only be about 1/10th as good! And yet one can hardly find a radio magazine today which does not print diagrams of this very type as used or recommended by companies or engineers, or technical writers.

The first step in my system was directed at this wasteful use of filter apparatus. In Fig. 2 I show the essential details of my circuit arrangement embodying what I call "proportioned filtration." The voltage-dividing resistor, that waster of our costly filtered current, is replaced by series resistors (or chokes, if desired) in which the filtered current loss is reduced to a minimum. They perform the double function of voltage regulators and filter devices. Here we note three filter stages in series: one, for the power tube stage, which is no better than necessary for it; two, for the radio-frequency and first audio-frequency tube group, which adds the required increased filtering to that of the first stage for these intermediate tubes; and three, for the

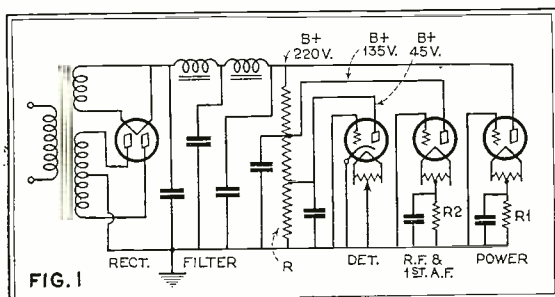

Fig. 1—A modern fundamental filter circuit

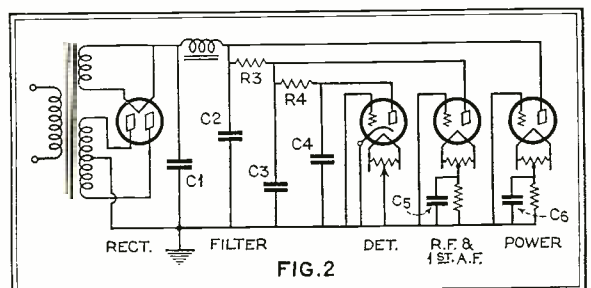

Fig. 2—These changes effect an improvement over the circuit shown in Fig. 1



# Hum

## How the Bad Features of the Old Power Supply Systems Were Eliminated and a Greatly Improved Circuit Substituted\*

detector, wherein the additional filter stage R4 C4 adds just enough filtration to that of the preceding two stages to clear the detector of hum. It may be noted here that the resistance values used are determined by the operating B and C voltages of the tubes they supply, and the filtering is regulated by proper choice of capacity. Further, the amount of filtering required for the power tube is determined by adjustment of filter elements while its grid input is short circuited. When this adjustment is completed the short circuit is removed and placed across the input to the first audio-frequency tube to keep out detector hum. Then the filter elements R3 C3 are adjusted for the first audio-frequency tube hum, amplified by the second audio-frequency tube or tubes. It may here be remarked that if the radio-frequency tubes have the same degree of filtration as the first audio-frequency tube, and the latter does not hum, then no difficulty with "B" ripple as a cause of carrier modulation hum in the radio-frequency tubes should be expected.

Finally, the first audio grid input short circuit is removed and placed across the detector grid input, while the third filter stage constants are adjusted for operating voltage and hum.

This series filter system has many advantages over the earlier "brute force" types previously discussed, and is much more efficient and economical.

It will be noted that this circuit eliminates all loss current, provides proper voltages for all tubes, regulates the filtering for given tubes to a degree determined by succeeding application, and eliminates the couplings between grid and plate circuits of different tubes previously noted.

With a circuit of this type it is ordinarily possible to produce better results with about one-third the amount of filter apparatus required by the first type, and with about one-half the amount required by the second.

If this last arrangement has filter elements so proportioned that hums from all tubes due to filter ripple are equally low and unobjectionable in a loud speaker, we may proceed further

\*Reprinted through courtesy of the Institute of Radio Engineers.



Benjamin F. Miessner standing beside an Oscilloscope which is employed in studying hum phenomena. The note books contain more than two thousand pages of notations, photographs and curves of this inventor's discoveries

to reduce the required amount of apparatus. This may be accomplished by reducing inductance or capacity in the first filter section so that the power tube develops a hum having a magnitude five or ten times the tolerable limit; that is to say, about one volt, if the predominant frequency, as usual, is 120 cycles. This is done also in the second filter stage, feeding the first audio tube, so that this produces a one-volt hum in the plate circuit of the power tube. If now the phases of these two hums be reversed 180° in the plate circuit of the power tube, by properly poling the second audio primary and by regulating the resistance R3 and condenser C3, these two hums may be neutralized. I call this type of neutralization "inter-stage hum bucking."

Hum may likewise be introduced in the detector stage by filter reduction and neutralized in either the second audio or power stages; or it may be added to or subtracted from the first audio hum, and the residual neutralized in the power stage.

If, as is usual, the radio tubes obtain their grid and plate voltages from the same points supplying the first audio tube, the best plan is to provide sufficient filter apparatus in the

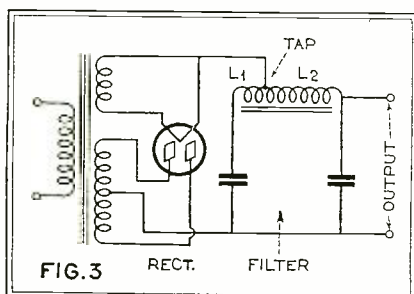
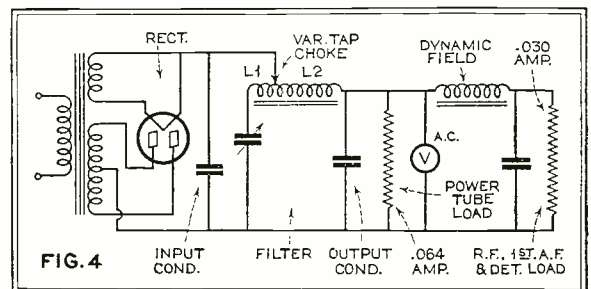

Fig. 3—Much smaller filter element values are made possible by the Miessner "tapped-choke filter"

Fig. 4—The circuit employed in measuring filter ripple and from which the curves in Fig. 5 were made





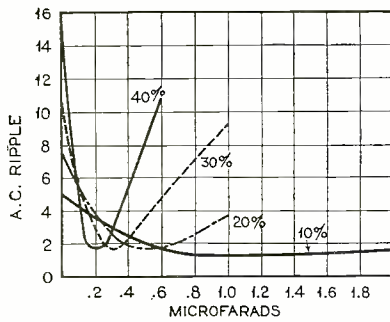

Fig. 5—Ripple measurement curves made with circuit shown in Fig. 4. The ordinates are arbitrary measures of ripple and the abscissæ are variable condenser capacities

appear when a carrier, whether modulated or unmodulated, is tuned in at the transmitter. The disadvantage of this scheme is that unless the audio hum be adjustable, the neutralization is complete only when the carrier input to the detector tube has a particular amplitude. This, as before mentioned, results from the fact that the carrier modulation amplitude is governed both by the receiver modulating influence and the strength of the carrier in the receiver itself.

In resistance-coupled amplifiers, such, for example, as the new Loftin-White circuit, the interstage coupling is of correct phase to produce this interstage bucking. It is necessary in amplifiers of this type only to regulate correctly the amplitudes of the hums by filter design to get neutralization. I am informed by Mr. Loftin that the low hum output of their amplifier is due largely to this and another of my bucking schemes, to be described later as "hum feedback," wherein the normal grid voltage ripple produced by the plate current ripple in a bias resistor, by the B supply is increased to a point where it neutralizes the plate ripple.

This is done by means of a condenser, or condensers and resistance, connected in series between B+ and the cathode of a given tube or group of tubes, so as to develop a ripple current in the bias resistor from B+ to B. When the phase of the ripple voltage across this bias resistor is correct and its amplitude, multiplied by the amplification factor of the tube, is equal to the plate ripple, neutralization occurs, and no ripple current flows through the tube, which behaves as if only the decomponent of plate and grid voltages were present. This will be described in detail later.

Another form of interstage bucking occurs in most receivers with one or more filament potentiometers. Assuming that fixed mid-point potentiometers or filament windings are used for power tube and first audio and r.f. tubes, and that an adjustable potentiometer is used for the detector heater, it is observed that a fixed mid-tap will provide minimum hum with only a small proportion of tubes, so that for most tubes it is somewhat out of adjustment, thus causing a 60-cycle voltage to be introduced in the grid of the particular tube or tubes which it serves. An adjustable detector heater circuit mid-tap may be made to neutralize the hum so introduced, by setting up the same type of hum in the detector stage. This, when amplified into the grid circuit of the first audio tube, will, if correct in phase, wave form and amplitude, neutralize the first-mentioned hum. The detector hum phase may be reversed and its amplitude regulated merely by adjustment of this detector potentiometer. The same effect may

second filter stage to prevent the introduction of hum by all of these tubes, and then to neutralize the power stage hum by that of the detector stage. Otherwise modulation hum may appear.

A purely audio hum without r.f. carrier can also be neutralized by carrier modulation, caused by insufficient filtration of the radio tube current. In this case the receiver may possess a strong hum when no carrier is received, which will dis-

be secured by using the adjustable potentiometer in the first audio stage instead of the detector. Sixty-cycle induction hum can also be neutralized to some extent in this manner.

### Tapped Choke Filter

Another method of considerably increasing the effectiveness of a given amount of filter apparatus, or of reducing the amount of apparatus required for a given output ripple, is what I call a "tapped choke filter."

This circuit is illustrated in Fig. 3. Here the rectifier is connected to the filter choke at some point near one end, the filter condensers being connected to the ends of the choke winding. An input condenser may also be connected across the rectifier if desired. This circuit ordinarily will reduce the ripple output by a factor of five to ten over that obtained with the same choke and condensers connected in the usual manner. Or, conversely, it will provide just as good a filter with considerably smaller values of the filter elements.

The increased filter action is due to a neutralizing effect between the a.c. components of the two portions of the choke. That is, a rather strong a.c. current component flows through the portion marked L1, the coupling of which to L2 neutralizes to a large degree the a.c. voltage component therein, so that the output a.c. component is reduced.

Curves showing the performance of this circuit accompany this article. These curves were made by Mr. Arthur B. McCullah of the Gulbransen Radio Corporation of Chicago and are here included by his kind permission. The circuit arrangement used is shown in Fig. 4. It will be noted that an input condenser is connected directly across the rectifier, that the vacuum-tube voltmeter for measuring the filter ripple is connected across the power tube load, and that the d.c. current in the filter is 94 milliamperes. You will note further that the condenser connected to the beginning end of the choke is variable.

Fig. 5 shows, for several tap-points on the choke coil, the effect of changing the variable condenser. The per cent. designations refer to the percentage of total turns in the input side of the choke coil. The ordinates are arbitrary measures of ripple, and the abscissæ are capacities of the variable condenser in microfarads.

You will note that while low ripple levels may be obtained with capacities as low as two or three-tenths of a microfarad, not much variation from the best value can be tolerated without increasing the ripples.

As the tap percentage increases the capacity increases and becomes much less critical. A 20% tap appears to be quite effective without critical condenser value.

In Fig. 6 is shown a family of curves indicating that the adjustment of the neutralizing condenser is not affected by change of input or output capacities.

Further tests have shown that if the full choke coil be used in a normal filter circuit, more than twice as much filter capacity is required to reduce the ripple to a given level.

This type of filter stage may of course (Continued on page 957)

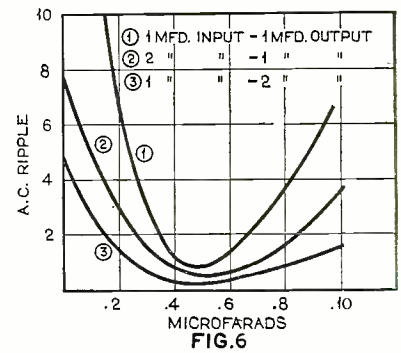

Fig. 6—These curves indicate that changes in input and output capacities do not affect the adjustment of the neutralizing condenser

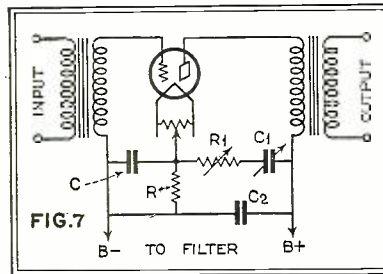

Fig. 7—This form of hum neutralization in a receiver circuit, instead of in the filter, is capable of surprising results, and is applicable to a single tube or a group of tubes obtaining their plate and grid-bias voltages from a common point

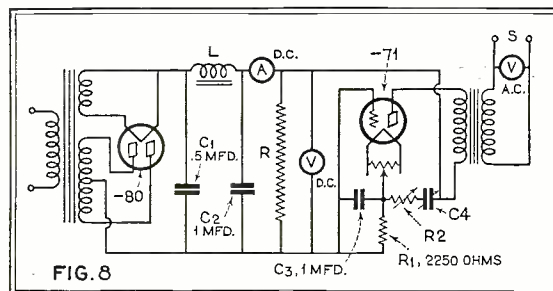

Fig. 8—The alternating ripple voltages are applied to both the grid and plate, but since they are neutralized at every instant no a.c. current can flow through the tube. Curves illustrating the performance of this arrangement appear in Figs. 9 and 10



# TELEVISION *Through a* CRYSTAL GLOBE

New Cone-shaped Tube Reproduces 4 x 5-Inch Picture, Is Quiet in Operation and Does Away With Need of Mechanical Parts in Home Receiver

By V. Zworykin

*Reprinted by courtesy of the Institute of Radio Engineers*

THE problem of television has interested humanity since early times. One of the first pioneers in this field, P. Nipkow, disclosed a patent application in 1884 describing a scanning of the object and picture, for which purpose the familiar perforated disk was employed and at present the rotating disk is giving excellent results within the mechanical possibilities of our time. The cathode-ray tube, however, presents a number of distinct advantages over all other receiving devices. There is, for example, an absence of moving mechanical parts with consequent noiseless operation, a simplification of synchronization permitting operation even over a single carrier channel, an ample amount of light for plain visibility of the image, and indeed quite a number of other advantages of lesser importance. One very valuable feature of the cathode-ray tube in its application to television is the persistence of fluorescence of the screen, which acts together with persistence of vision of the eye and permits reduction of the number of pictures per second without noticeable flickering. This optical phenomenon allows a greater number of lines and consequently better details of the picture without increasing the width of the frequency band.

This paper will be limited to a description of an apparatus developed in Westinghouse Research Laboratories for transmission by radio of moving pictures using the cathode-ray tube for reception.

In the author's opinion, if a receiver is to be developed for practical use in private homes, it should be designed without any mechanically moving parts. The operation of such a receiver should not require great mechanical skill. This does not apply to the transmitter, since there is no commercial difficulty in providing a highly trained operator for handling the transmitter, which consists of a modified standard moving (Continued on page 949)

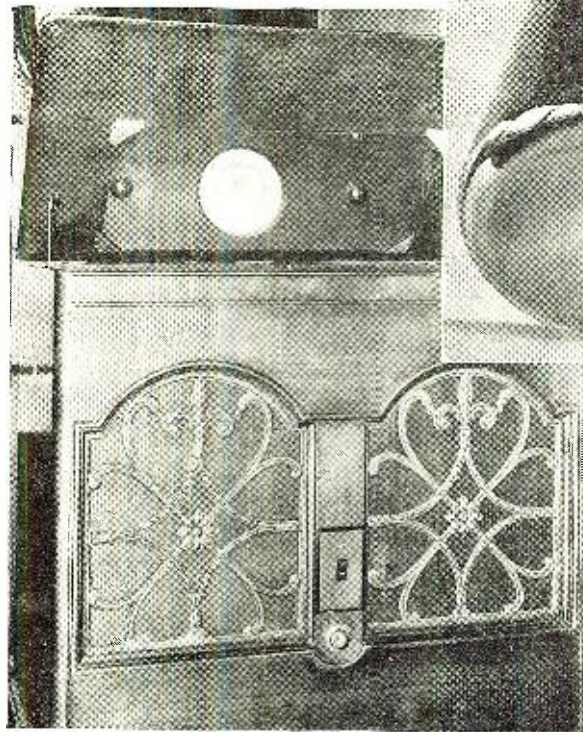
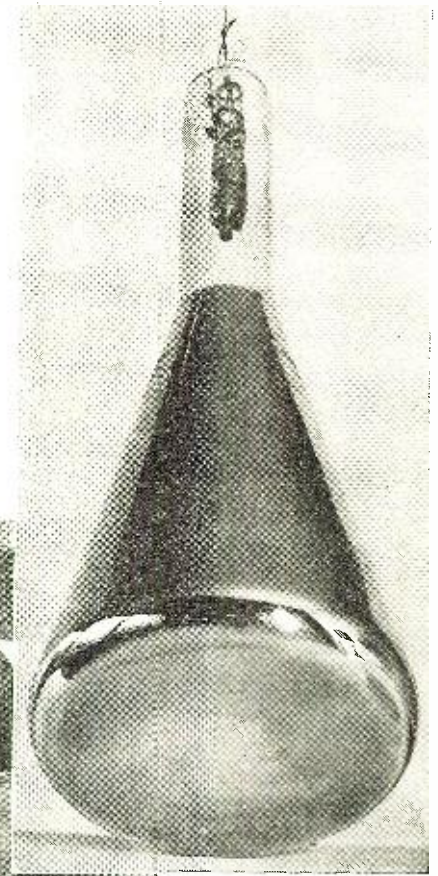

Fig. 1 (above)—A cathode-ray tube—the heart of the Zworykin receiver. Fig. 2 (left)—One type of cabinet receiver housing the Zworykin apparatus

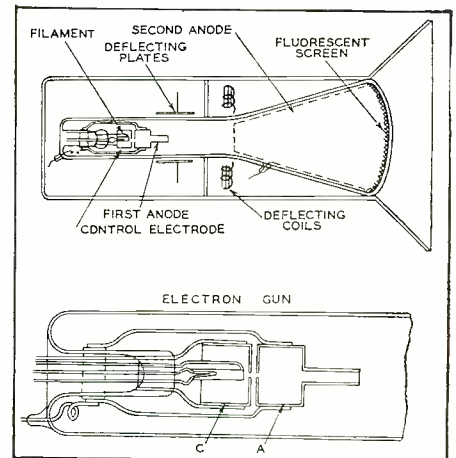
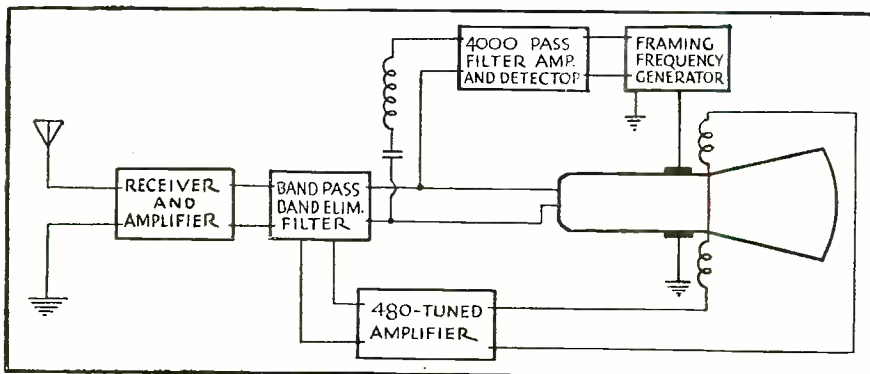

Fig. 3 (above)—Cross-sectional view of cathode-ray tube, including an enlarged drawing of the electron gun. Fig. 4 (left)—Diagram of the band-pass filter which divides the local receiver output into the picture and synchronizing frequencies





By J. E. Smith\*

**T**HE establishment of radio aids to navigation along the 10,000 miles of airways in the United States will entail an expenditure of approximately \$1,000,000 of government funds during the next eighteen months. These

ground facilities for guiding aircraft by virtue of invisible radio waves in fog, darkness, or in other obscure conditions of flight will include directive and marker radio beacons, radio-telephone transmitting equipment for broadcasting weather reports, and apparatus for the transmission of guiding signals which may be received on board flying craft either aurally or visually. One manufacturer of radio equipment, for example, is now marketing airplane receiving outfits which are capable of intercepting either aural or visual radio beacon signals.

A division of opinion has arisen among government administrative officials as to the inherent comparative values of visual and aural aircraft beacon systems. In recognition of this lack of agreement, an experimental visual type of beacon transmitting system is to parallel the present and older ear method of signals already in operation on several civilian airways. The Airways Division of the Department of Commerce is now constructing seven visual-indicator transmitting sets at the shops of the Lighthouse Service in Detroit. These government-built units are to be augmented by approximately twenty-five visual transmitting beacons, to be manufactured by commercial concerns, at an expenditure of approximately \$250,000. This development would seem to suggest a gradual shift from the aural to the visual beacon system.

Paralleling this apparent transition from the ear to the eye

\*President, National Radio Institute.

method of guiding aircraft beacon signals, however, is the recent decision of the Airways Division of the Department of Commerce to build fifty new directive aircraft radio beacons of the aural type. These transmitting stations, involving an

**T**HE Airways Division of the Department of Commerce recently decided to build fifty new directive aircraft radio beacons of the aural type, involving an expenditure of approximately \$400,000.

Marker beacons are to be established as auxiliary radio aids to air navigation, augmenting the services of the directive or guiding type of beacon.

When the aviator is flying on his appointed course he will receive almost constantly invariable signals, but if he wanders from the airway there will at once be an inequality of the radio signals.

It is steps such as this that point the way to a safer, finer future for aerial navigation.

These transmitting stations, involving an expenditure of approximately \$400,000, will have been constructed and in operation in twelve months. Eleven of these fifty beacon stations will be located on the Los Angeles-Seattle Airway, five on the Atlanta-New York Airway, and others will be installed on airways from Wichita, Kansas, to Chicago, and from Omaha, Nebraska, to the Pacific Coast. The eleven beacon stations authorized for the Los Angeles-Seattle Airway are the first government radio installations of the kind in the far west and likewise the five stations in contemplation for the Atlanta-New York Airways are the first units of this character installed on the southern flying route.

When the fifty new aural beacons are completed there will be a total of fifty-nine such stations in operation. The nine existing units are located at the following points: Cicero, Illinois; Boston, Massachusetts; Key West, Florida; Des Moines, Iowa; Sterling, Illinois; Goshen, Indiana; Cleveland, Ohio; Bellefonte, Pennsylvania; and New Brunswick, New Jersey. The radio transmitting set at New Brunswick serves airplanes flying the New York-Hartford and New York-Washington

Airways, as well as planes operating between Bellefonte and New Brunswick. These so-called radio range or directive beacons will have a power rating of 2,000 watts and the radio transmitter and auxiliary equipment will be of standard design. H. J. Walls, in charge of aircraft radio for the Airways Division, on a recent western inspection tour discovered that the



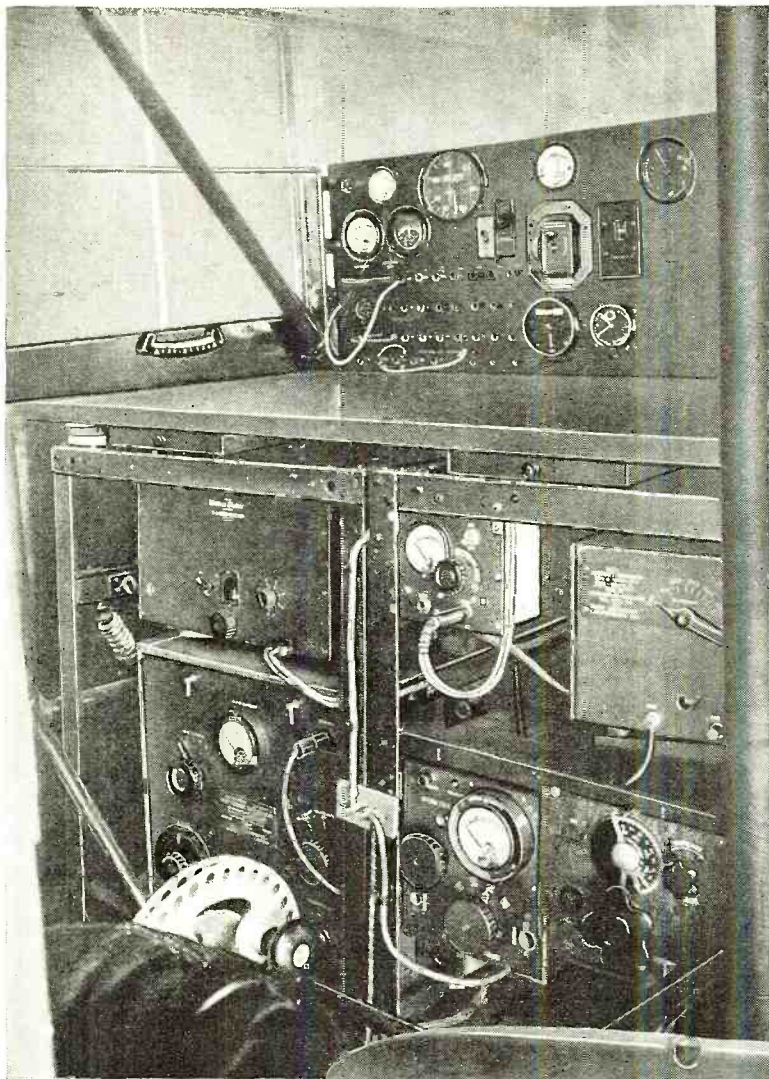

The Department of Commerce airplane used in airway charting. In the exterior view the vertical aerial may be seen above the cabin. The apparatus below the table within the cabin are: W.E. 8-A broadcast band receiver, Signal Corps plane transmitter for C.W. phone, and I.C.W. The counterpoise reel is also visible

marked difference in terrain requires the establishment of these beacon stations at irregular intervals—some 200 miles apart and others at 50-mile intervals. In fact, the character of the terrain, rather than the vagaries of radio waves, will be the determining factor in the distances at which the stations are separated.

The aural or ear beacon system, as the term implies, signifies that the pilot must wear head-telephones in order to intercept the dots and dashes as a means of directing his course of flight. Only a simple receiving set is necessary in order to utilize radio guidance—together with a battery supply weighing about eighteen pounds. The ignition system of the airplane engine is shielded to prevent interference with radio reception. The receiver is uni-controlled, having one tuning knob mounted on the instrument board and an adjustment whereby the signal intensity can be varied by manipulation of a knob on the control panel. The trailing-wire antenna may be displaced by an experimental six-foot vertical rod

devised by the radio laboratory of the Bureau of Standards. The pilot receives the signals by means of headphones incorporated in his helmet. If the airplane wanders from its appointed course either to the right or left the signal from the directive radio beacon increases in intensity on one side and decreases in strength on the other side so that it is necessary only to alter the flying course.

The ground facilities for charting airplane courses may be described by observing examples of the directive radio beacons in operation. For instance, there are three beacons of the aural type on the Cleveland-New York Airway—sending on frequencies in the 285 to 315-kilocycle band. The antenna system is supported by a vertical pole—equivalent in arrangement to two giant loops spaced 120° apart. The pattern of the signal of each loop is the figure eight. The loops intersect at 120° and, consequently, the patterns overlap. The radio transmitting set emits a signal through each loop in sequence, and in such a way that the overlapping pattern interlocks. The result is a prolonged dash at the points of equal intensity, by combining two signals. A goniometer or direction-focusing instrument is employed at the beacon station for shifting the pattern of each signal around the horizon, thus radio-charting the airways. Usually there are four interlocking signals. At Hadley Field, New Jersey, the giant coil antennæ are positioned in a 90° relationship to each other, and three of the interlocking courses may be adjusted so as to chart the airways leading to Hartford, Connecticut; Bellefonte, Pennsylvania; and Washington, District of Columbia. At Bellefonte the pattern of the signal has been changed by use of a vertical antenna in conjunction with the giant coils of wire. This serves, in effect at

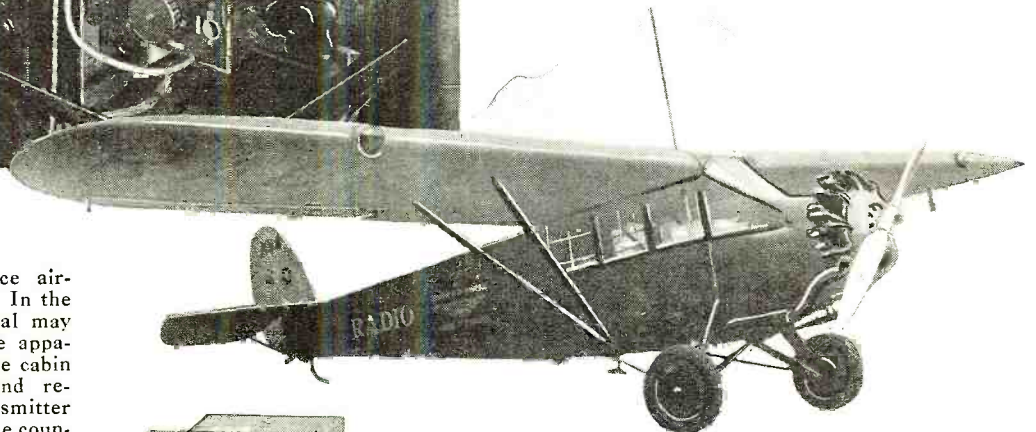

(Left) Two types of vibrating reed visual indicators which show the pilot whether he is on or off his course

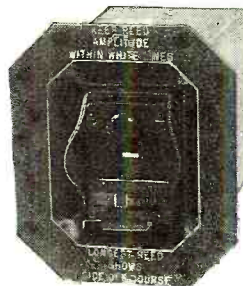

least, to bend the airway at the beacon station to coincide with the flying routes leading eastward to Hadley, New Jersey, and westward to Cleveland, Ohio.

To give further flexibility to the beacon system—affording guidance over twelve, instead of from one to four, airplane courses—a multi-course beacon has been developed. An officer directing traffic at the intersection of a dozen streets, vehicles going in all twelve directions at the same time without interruption, is an imaginary illustration analogous to the new method of directing airplanes along twelve different highways of the air by radio. The twelve-course aircraft radio beacon, designed by Harry Diamond, in charge of the Bureau of Standards' program for the development of radio aids to air navigation, is a modification of the present double-modulation directional beam system. This, briefly, consists of a radio transmitting station whose output



(Below) The goniometer, a form of radio compass, is used in the allocation of guiding radio signals over a dozen airways at the same time

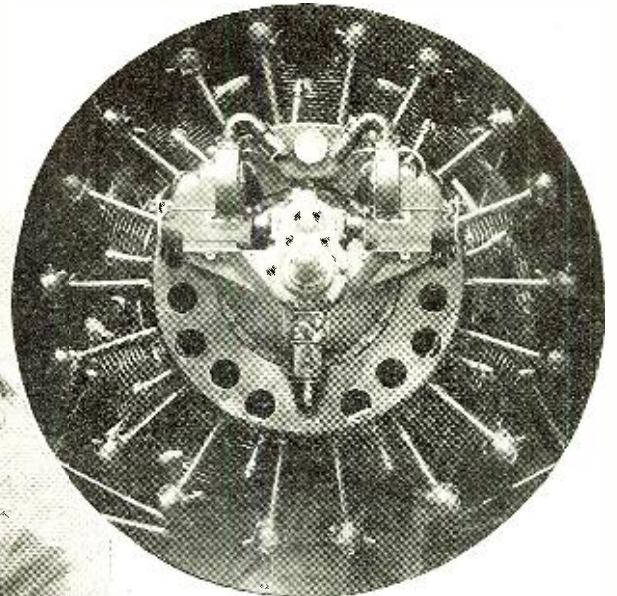
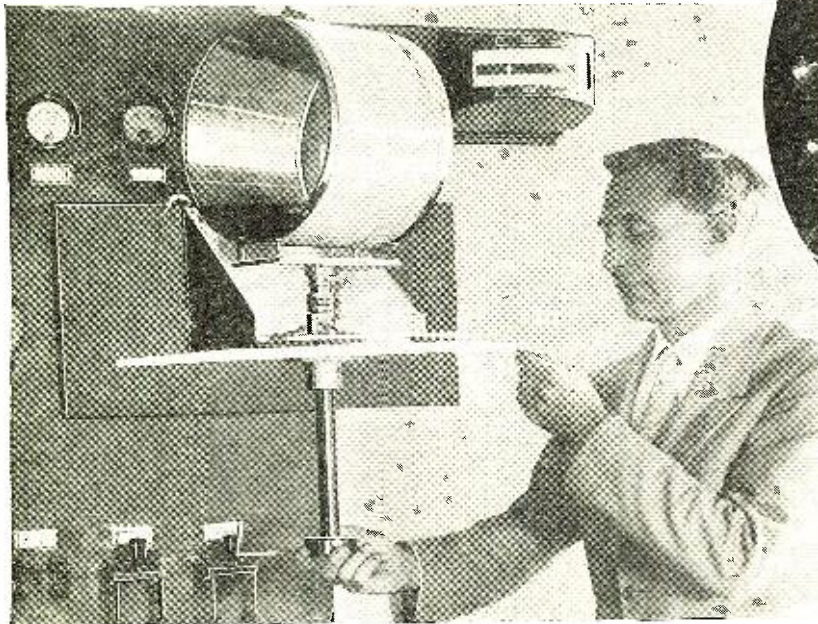

(Above) Shielding applied to an airplane engine in order to suppress interference, thereby making radio reception possible

feeds separately into two giant coil antennæ crossed at an angle of 90°. One of these emits a 290-kilocycle wave, modulated to 65 cycles, while the other radiates an identical wave frequency, but is modulated at 86.7 cycles. In the twelve-course beacon the same crossed-loop antenna system is employed, and the circuit arrangement has not been radically modified—in fact, only three radio amplifier units are added and three, instead of two, modulation frequencies are used. These are 65, 86.7 and 108.3 cycles, respectively.

A special goniometer (an instrument for measuring angles) is essential, however, when a traffic officer, for example, is imparting orderly system to dispensation of guiding radio signals over a dozen airways at the same time. This device, employed to orient the beacon course in any desired direction, involves the use of three stator coils when twelve airways are to be served with guiding wireless signals. One stator coil is associated with each vacuum tube used as a power amplifier. These stator coils are positions at 120° with each other, but these angles are subject to deviation to suit changing conditions. The rotor element of the specially designed goniometer is identical with that used when only one or two airways are to be

served. The multi-course beacon, it is contemplated, will be operative in cities where a number of airways converge. Like railway engines racing back and forth on myriad tracks at a switching yard and guided by vari-colored signals, the passengers and cargoes of the air will travel their appointed courses—figuratively riding invisible radio rays. An experimental installation of the twelve-course beacon has been made by the Bureau of Standards at College Park, Maryland.

The twelve-course beacon is designed to be responsive to the visual type of directive beacon—requiring the use of three steel reeds on the airplane instrument board instead of two, as in the simpler type of transmitting beacon. The visual indicator, as the term implies, permits the pilot to dispense with head-telephones in the reception of guiding radio signals, and it is necessary for him only to consult the instrument board occasionally to determine if he is flying on the appointed course. Developed by Francis W. Dunmore of the radio laboratory of the Bureau of Standards, the eye system of receiving airplane-guiding radio signals consists of two or more abbreviated steel strips or reeds. These vibrate in harmony with the modulated frequencies from the directive beacon transmitting station. The device is employed in conjunction with the radio receiver on the flying craft; the indicator being plugged into the jack of the receiving set where ordinarily the head telephones or loud speaker are connected. The audio-frequency currents of the airplane radio receiver pass through

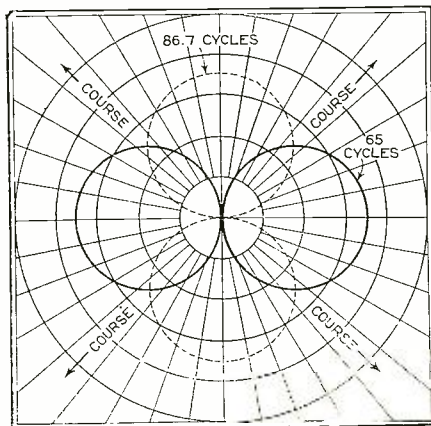

The map above indicates the pattern of the signal for each loop, which takes the form of a figure eight  
Right: Fundamental circuit of transmitter used in transmitting beacon signals

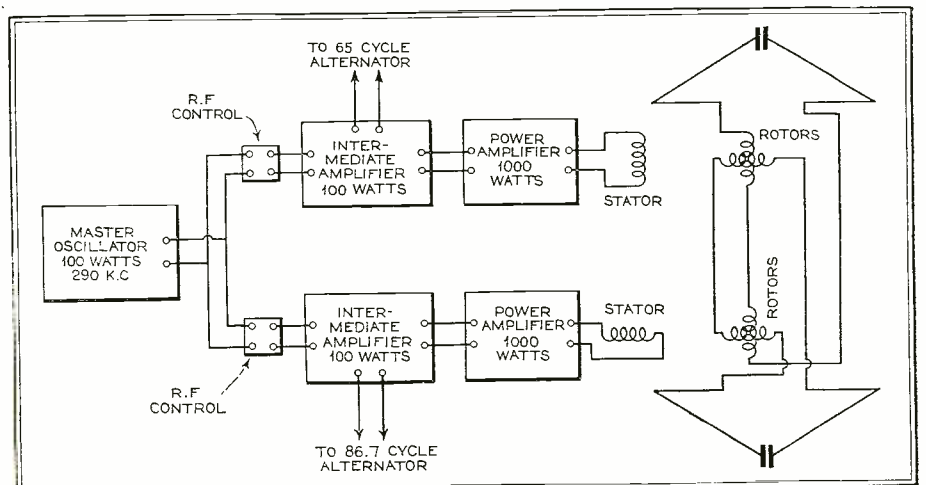



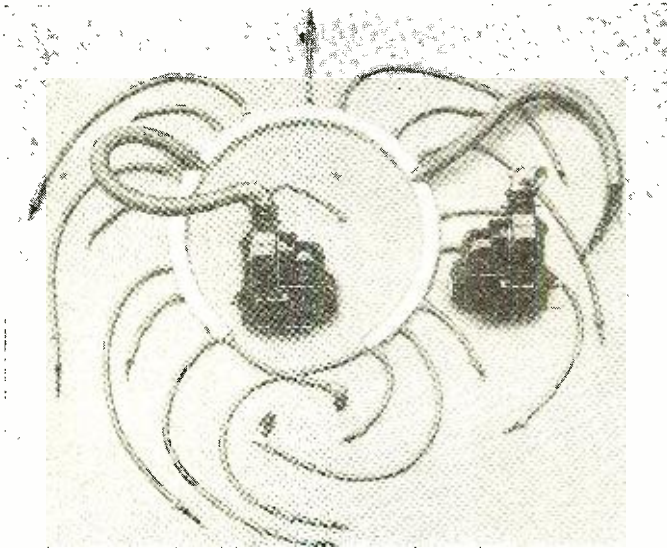

The entire ignition system of an airplane must be shielded in order to make radio reception possible. Photograph above shows the armored cables with housing spark plug leads removed

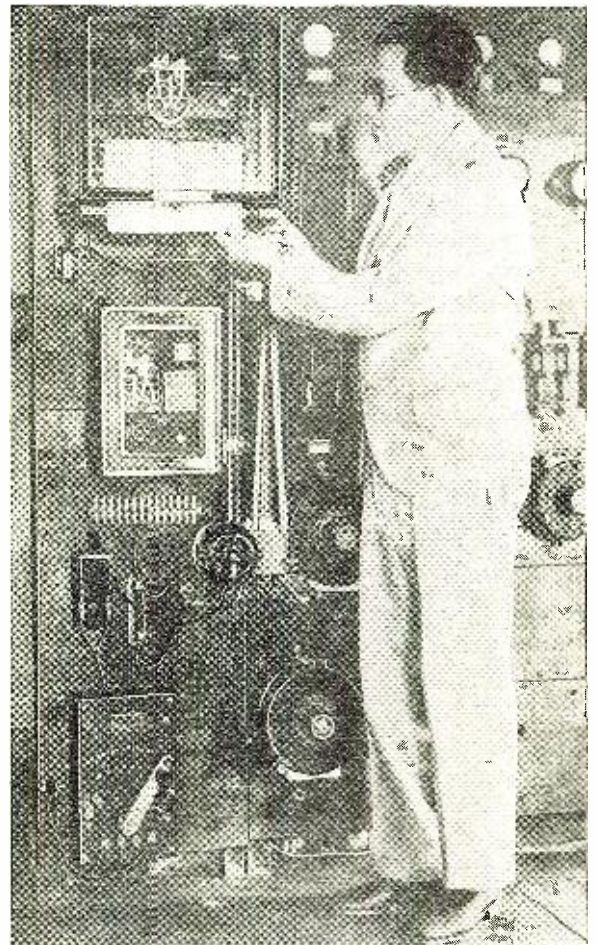

Harry Diamond, designer of a twelve-course aircraft radio beacon, who is in charge of the Bureau of Standards program for the development of radio aids to air navigation. He is standing before weather-recording instruments

a set of coils, the current actuating the steel reeds. If the signals from the beacon transmitting station on the ground actuate these two reeds with equal strength, the pilot is so informed on the instrument board—and this may be accepted as an indication that the airplane is flying true to its well-defined path. The tips of these steel reeds appear as vertical lines, charting the course of flying craft as though by means of chalk marks. If the two white lines develop an inequality of length, this may be accepted as an indication that the airplane has swerved from its course, the direction to be determined by noting which reed has shortened.

Marker beacons—popularly described as milestones on the highways of the air—are to be established as auxiliary radio aids to air navigation, augmenting the services of the directive or guiding type of beacon. The marker beacons are to be sandwiched freely between the radio range or directive beacon—two or three for one of the latter. Costing approximately \$1,000 each, the marker beacons are to be so situated as to define the end of different airplane courses and mark high elevations along the route. They will be sources of weather information by radio-telephone to the pilot, as well as indicators of the location of his plane with respect to ground positions. Marker beacons will utilize only a few watts of power—thus avoiding possibility of interference with other radio services—and will emit a characteristic signal, capable of interception by the pilot for a period of one or two minutes. This non-inductive type of radio beacon will not only prove useful in flying routes which deviate from a straight line, but

will be a source of information, supplying the pilot with wind velocity and direction.

The Airways Division, in co-operation with the Weather Bureau, maintains approximately thirty radio stations for the exchange of weather reports and for the dispatch of airplanes—and this list of stations is cumulative. The telephone and teletype augment the radio broadcasting weather reporting services.

Returning to the broadcasting stations, there are three in operation—at Hadley Field, New Jersey; Bellefonte, Pennsylvania; (Continued on page 969)

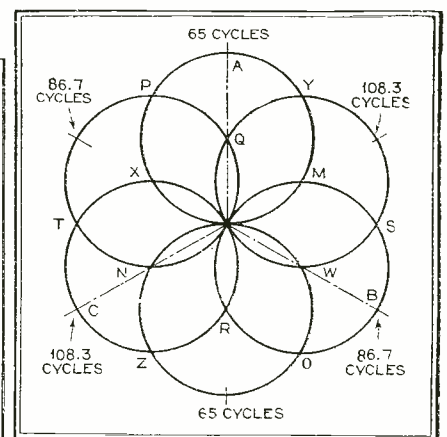
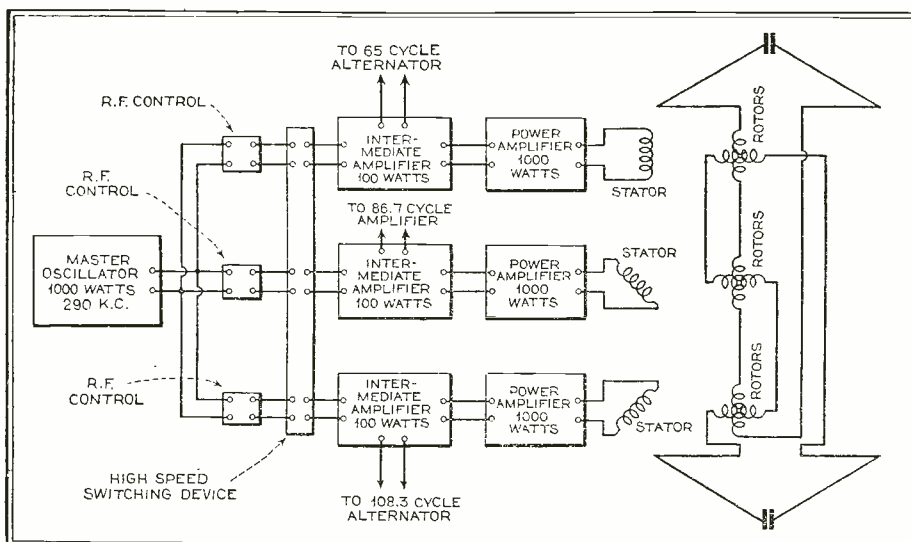

The map above shows a pattern of the loop signals when three are transmitted by the same station (Left) The fundamental circuit for the transmission of three signals of differing frequencies from a single master-oscillator source



# An 1930

By  
Robert Hertzberg\*

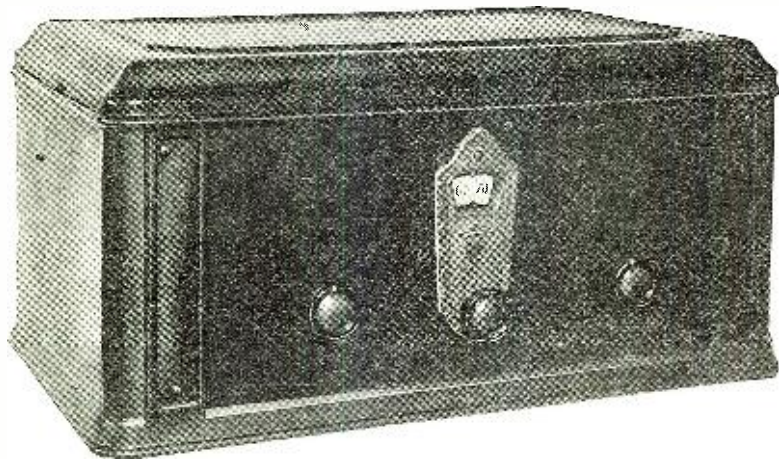

(Above) The completed receiver has all the appearance of a factory product. The knob on the left is the power switch, the one on the right the volume control. All tuning is done by the single vernier dial

(Right) The cabinet with cover removed. In the center is the triple tuning condenser; at the right the shielded plug-in coils and the screen-grid tubes; at the left the components of the audio system. The power pack is mounted against the back of the cabinet by means of a heavy U-shaped bracket, supplied with the kit

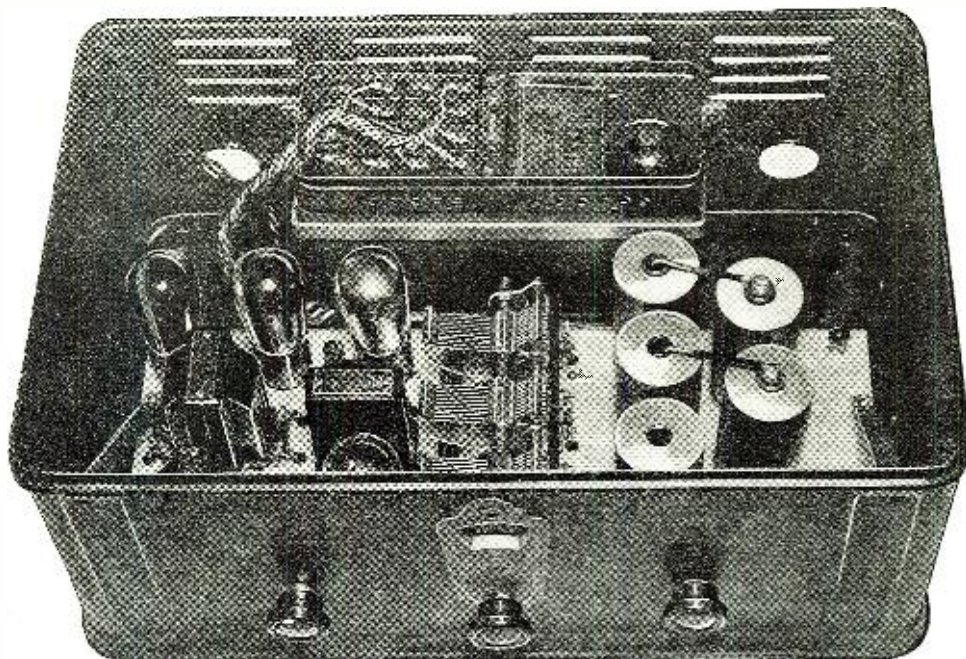

FROM their sometimes disappointing experiences with ordinary tuned r.f. circuits in which they have attempted to use screen-grid tubes without considering the unusual characteristics of the latter, many radio set constructors have come to the conclusion that selectivity in a screen-grid receiver is obtainable only with the aid of "band-pass" tuners or other technical tricks. This is not altogether true, although the band-pass idea is a very good one. A screen-grid receiver can be made selective enough to meet present-day reception conditions if the antenna transformer or "coupler" is properly designed, and if an aerial of the correct dimensions is used.

With very loose coupling between the antenna circuit and the input circuit of the first screen-grid amplifier, and with a very small aerial (ten or fifteen feet of wire in New York), a screen-grid receiver of very simple and inexpensive design can be made to separate the local stations quite cleanly, and even leave enough room in between to allow a DX station or two to be tuned in. The tremendous amplification afforded by screen-grid tubes compensates for the small pick-up system, and the set can and will deliver signals of considerable strength. As the size of the antenna is increased, the signals naturally increase in number and in volume, but the selectivity also goes down, although not as much as one might expect. In an upper Bronx apartment house, for instance, an eight-foot length of No. 24 copper wire, hidden beneath a rug, brings in all the local stations with enough volume actually to hurt the ears, and with two-degree selectivity. It also brings in, with comfortable loud speaker intensity, the more powerful stations in Hartford, Pittsburgh, Cincinnati and Chicago. A 95-foot outside aerial overloads the r.f. tubes, but still the local stations can be separated.

So successful were the experiments conducted with a screen-grid receiver embodying the foregoing ideas that it was decided to market such an outfit in kit form. The new kit contains all the necessary parts in fully prepared form and can be assembled by people who have had little or no technical experience. The receiver is an excellent "first" set for the grown-up radio fan

or for his young son. It makes a marvelous gift for a boy, although, like most mechanical instruments, it usually provides the father with more fun than it does the son. It is by no means a toy, but an honest-to-goodness broadcast receiver that will work fully as well as many factory-built sets costing considerably more.

Known generally as the Pilot "P. E. 6," the new receiver is available in three forms. The components of the six-tube circuit are the same in all three kits, but in the first, the K-122, a plain front panel, without cabinet or power pack, is supplied. This "chassis" model may be installed in any standard 7 by 13 cabinet or console, the panel being 7 inches high and 18 inches long, and the sub-panel  $7\frac{1}{2}$  inches deep. The second kit, the K-123, has the same sub-panel, but is supplied with a decorative steel cabinet finished in walnut. The front of this cabinet is drilled for the tuning dial, switch, and volume control, the sub-panel being mounted directly against it. This kit does not include a power pack, the latter being furnished with the third kit. The pack is a standard -71A unit, and is not supplied with the first two kits because many people may have packs that are perfectly satisfactory. The pack supplied with the third kit, the K-124, fits nicely inside the cabinet, behind the receiver sub-panel, a suitable mounting bracket being furnished.

A study of the diagram of the receiver, Fig. 1, will show that two stages of tuned r.f. amplification are used, with screen-grid tubes. These are followed by a non-regenerative detector, one stage of straight transformer-coupled audio, and one stage of push-pull audio, using -71A tubes. The use of -71A's may be criticized by some, but it is justified. They can handle more power than most persons of normal hearing can possibly

\*Pilot Radio and Tube Corporation.



# Inexpensive Broadcast Receiver

*Here's a new kit job, easy to assemble and wire, which will perform with amazing distance-getting and tone quality ability.*

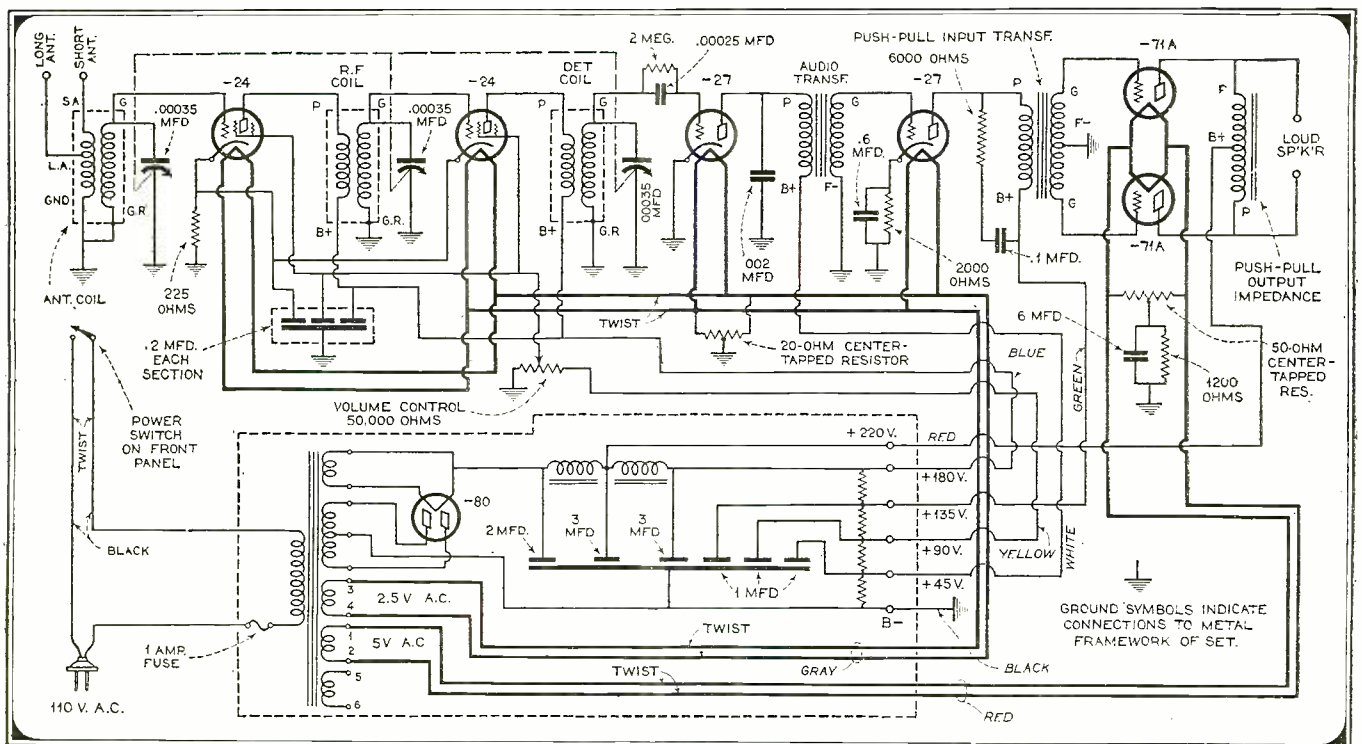

Two a.c. screen-grid tubes are used in the tuned r.f. stages, a -27 in the detector and the first audio stage, and a pair of -71A's in the push-pull audio amplifier. Above are shown the circuit details for the receiver and power supply units

stand, and incidentally they lower the price of the set because a -71A power pack is considerably cheaper than a -45 pack. However, -45's

Under view of the set, with the bottom unscrewed. Notice how really little wiring there is and how comfortably all the parts are spaced

can be used if the builder desires, the only necessary change being in the biasing resistor. The 1,200-ohm resistor, which connects to the midpoint of the resistor shunted across the filaments of the push-pull tubes, should be replaced by another of 750 ohms resistance, and, of course, a -45 power pack installed.

The antenna coupler, the interstage r.f. transformer, and the detector r.f. transformer take the form of shielded plug-in coils which fit in standard tube sockets. The primary of the antenna coupler consists of only ten turns, as compared with 127 on the secondary, and those ten are tapped at the seventh turn so that either seven or ten may be used, depending on the size of the antenna. A short antenna allows the use of the full winding; a longer one requires the smaller section. Two antenna binding posts are provided, so that the individual owner can suit the coupling to meet his local conditions. In or around New York an outside antenna is altogether unnecessary, as ten, fifteen, twenty or thirty feet of wire tacked along the edge of the floor will deliver satisfactory signals.

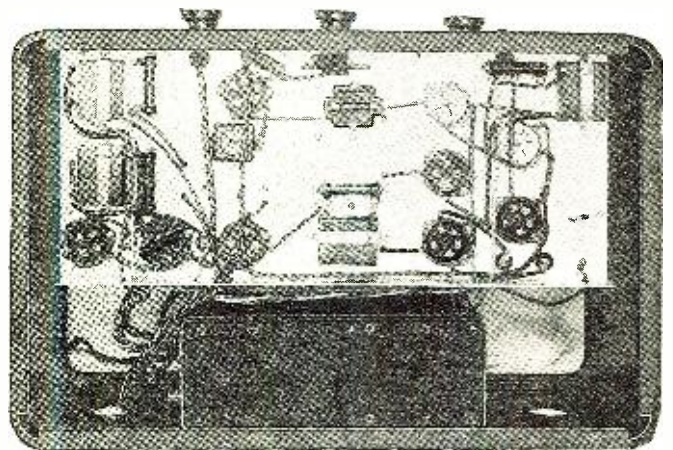

The interstage and detector coils have very large primaries (50 turns), wound directly over the filament end of the secondaries. The cathode, screen and plate circuits of the screen-grid tubes are adequately by-passed by a three-section, non-inductive filter condenser. The volume is controlled by a 50,000-ohm potentiometer which regulates the screen-grid voltage. This is the simplest method of control in a screen-grid set, and a very smooth and effective one. The r.f. circuits are tuned by a triple-gang variable (Continued on page 966)



# Building and AUTO-RADIO

*Many new factors determine automobile receivers. Here be of assistance regardless of*

By Philip

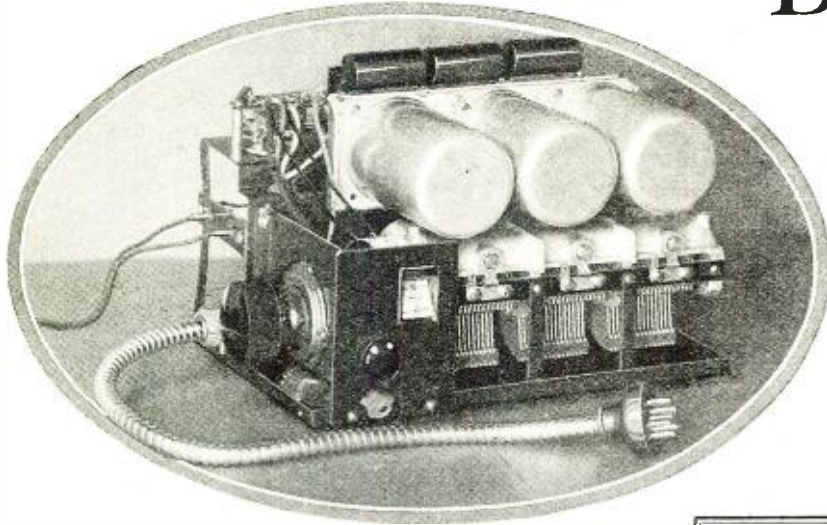

Compactness is the order of the day in the design of auto-radio receivers. Above, the front view of the National job. Note the absence of remote tuning controls, tuning being accomplished by a vernier knob, as in any other type of radio receiver

**R**ADIO for the Ford presents a few problems not encountered with other makes of cars. In most all other automobiles ample space is available directly behind the dash or instrument board for a compact receiver such as shown in some of the accompanying illustrations. The gasoline tank, however, takes up all such available space in the different Ford models. Of course, the set may be located in a protective metal box under the floor, or in the case of roadsters and coupés, in the luggage compartment in the rear. Such practice, however, requires the use of remote tuning control, which, while something many manufacturers are trying to perfect, so far has not yet made its appearance in practical commercial form at a reasonable price.

The receiver described here is so compact that it may be suspended from two small brackets mounted on the front of the dash, the rear of the front seat or any other such place that may be preferred. The electrical connections are made by inserting the connector plug at the end of the shielded cable into the socket on the side of the small outlet box which is permanently mounted in the car and connected to the various battery terminals. To complete the installation, the antenna and the loud-speaker leads are plugged into the tip-jacks provided for that purpose on the end of the receiver case. The outlet box also serves the additional purpose of making possible the use of a standard receiver in any make of car regardless of whether the positive or the negative side of the storage battery is grounded, without changing any connections in the set itself. This versatility is achieved through the internal connections of the outlet box.

Aside from permitting the quick installation and removal of the radio set from the car, simplifying the original installation work, providing readily accessible fuses, and eliminating wiring changes for different makes of cars, the use of this system of installation greatly increases the usefulness of the set itself. By merely obtaining additional outlet boxes and sets of batteries, the car radio becomes available on short notice for use

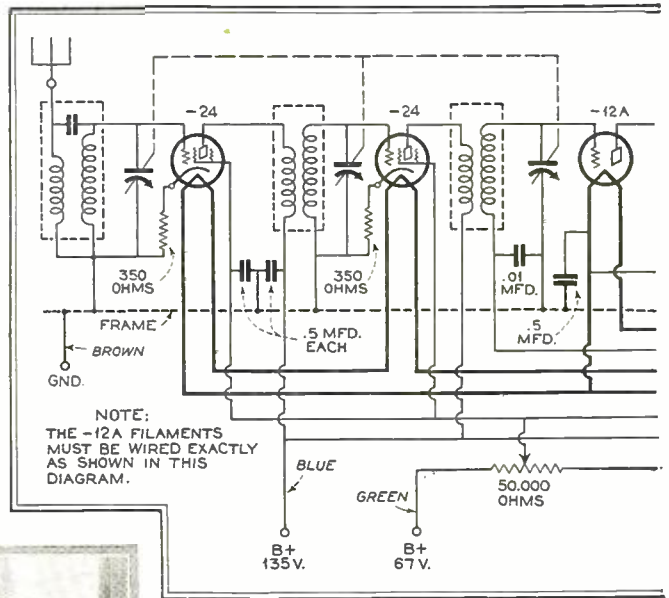

To the left is shown the novel manner in which the dash. Thus it is near enough to the driver's shaft remote tuning control. Above is the Note the special precautions in wiring which out of the receiver, fuse box, battery container are connected to the set. Use of the fuse block tically any

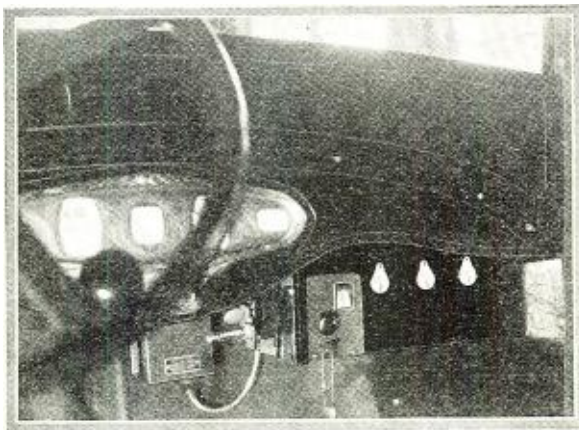

in the summer camp or on the boat. It will be found in such instances that the automobile type of radio receiver will give particularly fine results as it will not then be operating under the handicap of an antenna with practically no pick-up, as in the case of automobile installations wherein antenna space is limited.

The tremendous improvement in results obtained with an automobile receiver when used with a long antenna in place of the built-in car antenna suggests the use of an auxiliary antenna which should prove quite useful on trips to the country or districts where signal strength is otherwise too weak for satisfactory operation using the inside car antenna. It could be arranged on a small reel built right into the receiver case, or perhaps mounted on the dash in the same manner as an electric cigarette lighter. A simpler, though somewhat less convenient method would be to carry a small coil of flexible wire with a clip on each end in one of the door pockets of the car. When needed, one end could be clipped onto the antenna terminal of the set and the other to a fence, branch of a tree or any other convenient support. In either case, however, about twenty-five feet of wire will prove adequate.



# Installing An RECEIVER

*design and construction of are presented data which will the type of car to be radio-ized*

A. Eyrick\*

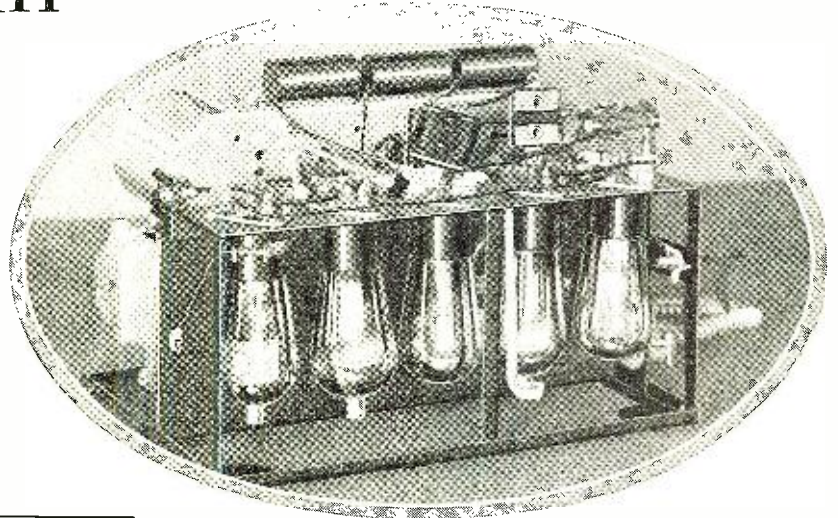

A rear view of the National receiver. Above the tube rack is placed the complete audio resistance-coupled channel of the receiver. Here's a set for car, boat or plane

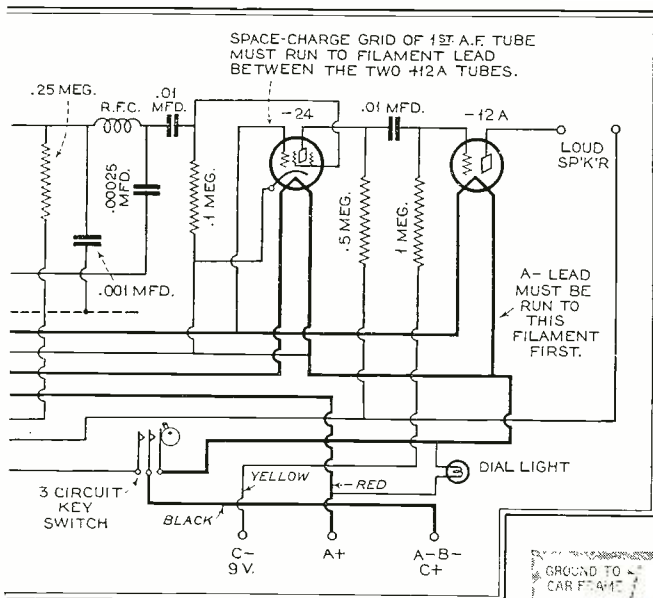

the receiver is slung from underneath and behind hands to make unnecessary the use of a flexible circuit employed in the design of the receiver. must be observed. To the right, a picture lay-and loud speaker, showing how these elements allows the employment of the receiver in prac-make of car

Another problem encountered in the installation of a radio receiver in a car is the choice of a loud speaker. During the past two years there has been an almost 100 percent shift on the part of broadcast receiver manufacturers from the horn to the cone type loud speaker in an attempt to improve tone quality. In the case of the automobile receiver, however, it would seem that best results are generally obtained from a special type of horn speaker—one which might not give particularly good results when used with a home radio set—or for that matter with the auto receiver when it is used in a camp or on a boat.

The reason for the frequently better performance of the short air column type of horn speaker in motor car use is most evident in cloth-upholstered sedan installations. In such instances reproduction from a good cone type speaker is quite muffled and distorted. This poor quality results from the greater absorption of the higher frequencies than of the lower frequencies by the upholstery and in addition to the resonant effects of the closed car body. A very interesting demonstration of the peculiarities of automobile radio acoustics may be

had by using a cone speaker with a cord long enough to reach to any part of the car. It will be found that while most positions of the speaker can give disappointingly poor results, there are at least two positions which are quite good. Unfortunately both of the good positions are about eighteen inches out diagonally from the two rear corners—and about half way between the top of the seat and the ceiling. The horn speaker, if made with a very short air column and small mouth, gives good response on the upper frequencies and particularly poor response on the lower frequencies—which tends to compensate for the reverse acoustical properties of the car interior, and the over-all result is quite pleasing, even though the speaker be placed out of the way behind the dash.

The specially designed cast aluminum horn speaker shown in the illustrations has an air column length of approximately 8 inches and a mouth opening of 2 inches in diameter. It is fitted with a balanced armature type unit totally enclosed in a dust- and water-tight case. The mouth of the horn is provided with a flange and mounting holes so that it may be fastened if desired behind a small round hole

cut in the dashboard. This opening may then be covered with a fine-meshed screen in order to give a more finished appearance to the installation. When it is undesirable to cut an opening in the dash the speaker may be mounted with a small metal strap or clamp behind the dash, over the windshield, or in the back of the car.

The frequency characteristics of the speaker just described are such that ignition noises are very much less troublesome than when using the cone type of speaker.

Moreover, because of its compactness and, incidentally, its low price in comparison to a 6-volt dynamic or magnetic type of cone loud speaker, it is possible to employ several of them, all connected to the receiver and placed in different parts of the automobile so that even on weak signals enough volume will be obtained to comfortably fill the car.

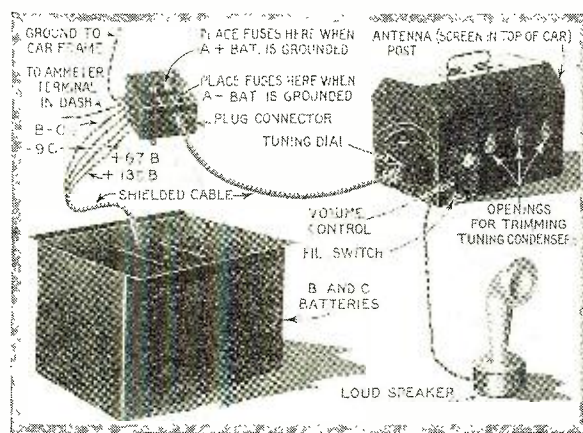

\*Radio Engineer, National Company.



# How to Adjust and Use a Beat-Frequency Oscillator

**T**HE beat-frequency oscillator consists of four 201A tubes, two oscillators, a detector, and an amplifier. The copper sheet panel serves as a supporting nucleus around which the entire unit is built. The large dial at the left in Fig. 1\* is the main tuning device, which is vernier controlled, and manipulates the three-plate variable condenser, C2. To the lower right is a mounted bakelite block which supports the filament rheostat R1 and six binding posts. The pair to the right form connections for the "B" battery B2, and the pair to the left are for the "A" battery B1, while those at the bottom are the output posts. The meter at the right top is an 0-8 Weston d.c. voltmeter M, for filament readings. The small knob at the left top controls variable condenser C1, which after all is not a variable condenser, inasmuch as it is a permanent fixture once it is set, being held in place by a set-screw.

Fig. 2 gives a fair idea of the interior arrangement. Again referring to the copper panel, one may see in turn the rear view of the meter M, the rheostat R1, and the two variable condensers C1 and C2. To the extreme right, and next to the panel, is the fixed condenser C6. The vacuum tube, V1, at the extreme right, works into the oscillatory circuit comprising the three adjoining honeycomb coils, L1, L2 and L3; the tube V2, immediately to the left of V1, works into its adjoining honeycomb coils, L1', L2' and L3'. The tube immediately under the meter is the detector, V3, and the left-hand tube is the amplifier, V4. The amplifying transformer T is in the central foreground.

The first r.f. oscillator, centering around V1, forms the familiar tickler coil regenerative circuit. C1, an ordinary three-plate variable condenser, varies the capacity across the inductance L2, which is a 1,500-turn honeycomb coil. L1 is a 500-turn honeycomb tickler coil which forms with L2 the means of oscillation. The grid condenser C3 is .00025 mfd. and the grid leak R2 is 5 megohms. The values of R2, R3 and R4 are by no means premature. Each must be determined by experiment, since it depends on the tube used and the coils.

The oscillating circuit centering around V2 is identical with that around V1, with the exception of R4, which is .25 megohms in this case.

It cannot be emphasized too strongly that these two oscillator circuits must be dealt with separately in the matter of securing the radio-frequency oscillations. At this stage forget coils L3 and L3'. First deal with the circuit of V1. When

\*Figure and parts numbers refer to illustrations in the first article on this subject in the March issue.

## Concluding Data on an Instrument for Which the Experimenter Will Find Many Uses

By John E. Fetzer

this is connected as shown in the diagram, insert a pair of headphones temporarily in series with the plate circuit next to the battery side of L2. While listening with this headset it is necessary to go through the usual procedure to secure oscillations, by varying C1 and the coupling between L1 and L2, as well as the value of R2. It may be necessary to reverse the connections leading to either L1 or L2 or both, before oscillations are secured. The familiar click in the headphones indicates oscillation, and with a little patience entire stability of the circuit may be secured.

### Complete List of Parts\*

- R1—1.5 ohms
- R2—5 megohms
- R3—2 megohms
- R4—¼ megohm
- R5—12.00 ohms
- M—0.8 d.c. voltmeter
- B1—6 volts
- B2—135 volts "B"
- T—Audio transformer or double impedance coupler
- L1, L1'—500-turn honeycomb coils
- L2, L2'—1,500-turn honeycomb coils
- L3, L3'—200-turn honeycomb coils
- V1, V2, V3, V4—201A tubes
- C1, C2—Three-plate variable condensers
- C3—.00025 mfd.
- C4—.00025 mfd.
- C5—.00025 mfd.
- C6—1 mfd.

The circuit of V2 may be brought into oscillation in the same manner. Deal with only one circuit at a time during this first adjusting process, taking care that the tube of the opposite circuit is not functioning, by disconnecting its plate supply. When these two circuits are working properly they will oscillate perfectly over the entire range of the variable condensers C1 and C2.

Our next step is to pick up a low-voltage from each oscillator by means of the series connected coils L3 and L3'. These are both 200-turn honeycomb coils used with the grid condenser C4 of .00025 mfd. and R3, a 2 megohm grid leak. It is evident that this pick-up voltage ex-

cites the grid of the detector tube V3. To simplify the adjusting procedure, omit, for the time being, the one-stage amplifier. Simply connect B2, a 135-volt "B" battery, to the plates of V1, V2 and V3. Insert the headphones in series with the plate circuit of V3 next to the anode connection. Condenser C6 is at least 1 mfd. capacity and is used to by-pass r.f. around the "B" battery—and don't forget that this condenser is important.

The three tubes V1, V2 and V3 should now be put into operation in what we may consider the most important step in the tuning process. After everything is set, bring both C1 and C2 to approximately the same setting or capacity. The chances are you will immediately hear the resultant beat-note in the headphones. Now permit C1 to remain stationary, and by varying C2 you will probably take in a considerable portion of the beat-note frequency range. When C1 is set properly, the entire range, from 20 cycles up, can be had by swinging the dial of C2 from the low to the high side. C1 may be a fixed condenser, but it is highly advantageous to use a variable condenser, inasmuch as the tuning changes slightly when the unit is moved in or out of the shielded cabinet. If the unit is tuned when out of the cabinet, it becomes necessary to make slight readjustments when it is placed inside. If C1 were fixed it would place a needless handicap on the constructor. Of course a strong set-screw on C1 may prevent longing hands from ruining a perfectly good adjustment. It also should be noted that some juggling of the number of plates in the condensers C1 and C2 is necessary in order to make the frequency range fit the dial. In the case of the apparatus under consideration, 20 cycles show up around 20°, and the frequency rises progressively to 90° or more.

The resistance R5 was not used with this oscillator but should be incorporated where variation in output is desired without changing the frequency. Do not attempt to vary the output by changing the filament rheostat. A slight change in this resistance will cause a considerable deviation in frequency. For this reason the voltmeter M should always read exactly five volts if constancy is desired.

Once the tubes are in use they should not be disturbed. In case the tubes are shifted in the sockets or a burnt-out tube is replaced it may be necessary to use new values of grid leaks as well as different coupling between the coils. If these changes are effected, a new adjustment of C1 becomes necessary, in order to keep the proper scale reading on the dial of C2.

If a standard oscillator is available for comparison, it ought to be relatively easy to calibrate the instrument.



USUALLY when short waves are mentioned experimenters think of the 20 or 40-meter bands. But these are considered as "long waves," so to speak, by the "hams" who have delved into the mysteries and vagaries of the 3/4 or 5-meter bands.

Mr. Binneweg, long associated with the progress of short-wave development, here recounts some of his highly interesting experiments in this unexplored realm of short waves. Other "hams" will be interested in attempting to duplicate his achievements.

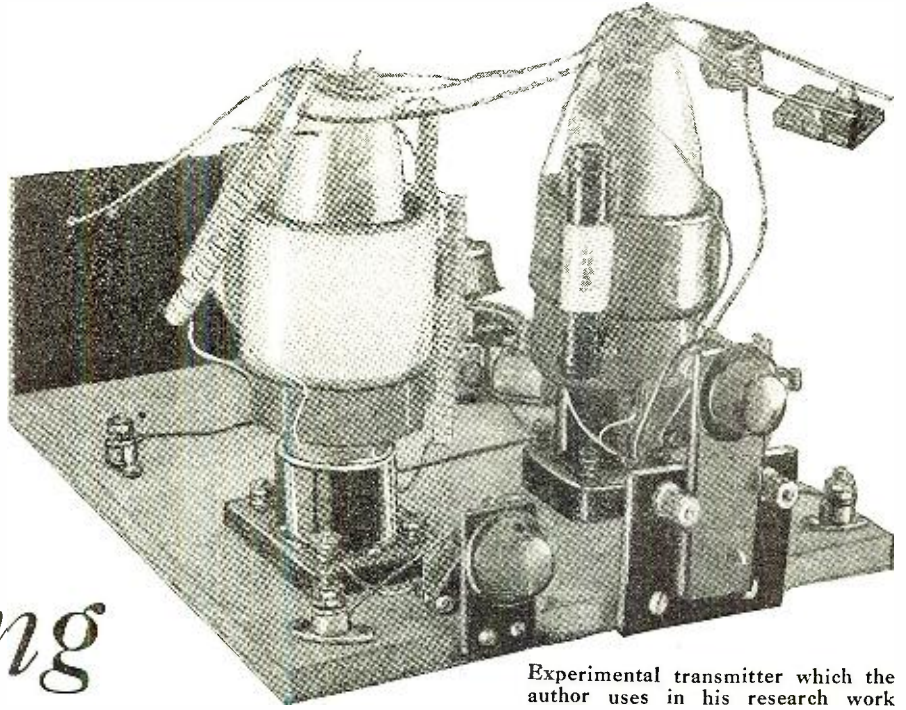

Experimental transmitter which the author uses in his research work

# Exploring the Ultra-Short Waves

*How to duplicate W6BX's 3/4, 5 and 10-meter transmitters with which some remarkable results have been obtained.*

By A. Binneweg, Jr.

OF unusual interest to experimenters are the ultra-high frequencies available to amateurs for experimenting in the higher frequency bands. Although at the present time they are practically unexplored, they will yield unusual results in the way of unexpected phenomena not apparent at the lower frequencies, but under the exaggerated effects at short wavelengths they can be made the subject for very interesting exploration and experiment. Some unusual effects have been noticed in working at these frequencies with apparatus easily constructed and economical in cost. The purpose of this article is to describe the practical details of apparatus which has been used, and which can easily be duplicated, as well as to outline the interesting effects that have been noted. It is interesting to contrast the apparatus described with that used at lower frequencies, and to duplicate the results obtained. There is much yet to be done.

Receivers for 60-megacycle (5-meter) use need special design and construction for proper operation, since effects perhaps negli-

gible in a 7.5-mc. (40-meter) receiver, for example, are exaggerated at the ultra-high frequencies. But there is no special reason why such requirements are similar to those for a 40-meter receiver in addition to those which result when the frequency is multiplied by 8 wherein the special features enter. Following are some practical details on the design and construction of receivers for use at these frequencies.

In general, due to greater losses, a 5-meter receiver will require higher plate voltages for proper oscillation. These losses are not readily apparent, but if the frequency and the distributed capacity effects are considered they become real. In one 10-meter low-power transmitter layout, for example, a simple test with a parallel-plate condenser and radio-frequency galvanometer showed that as much as 50 milliamperes (loss) of current would flow through a capacity as small as 1 1/2 mmfd. Calculations will also remove any doubt as to the effect of small capacities. Distributed effects can easily mount up to 1 1/2 mmfd.—and more. Thus when an attempt is made to

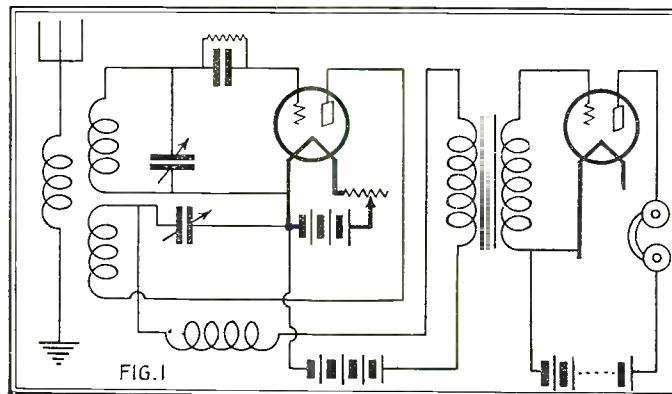
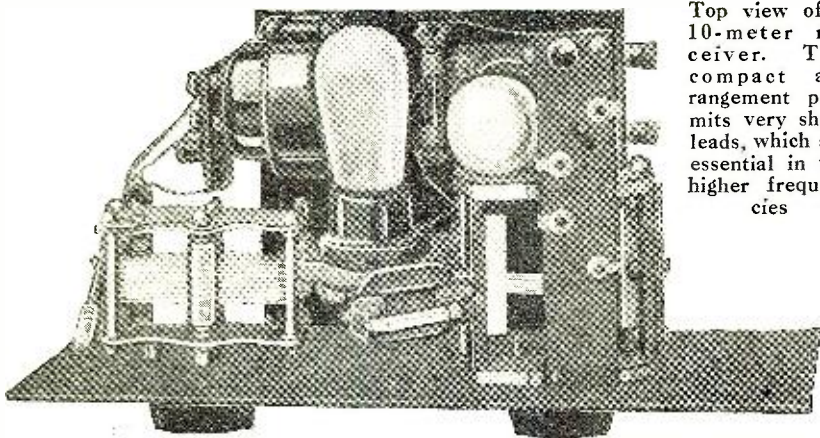
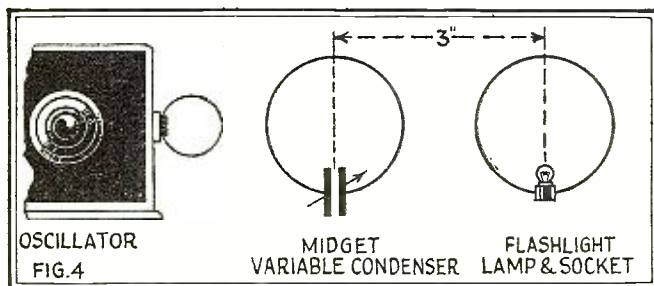
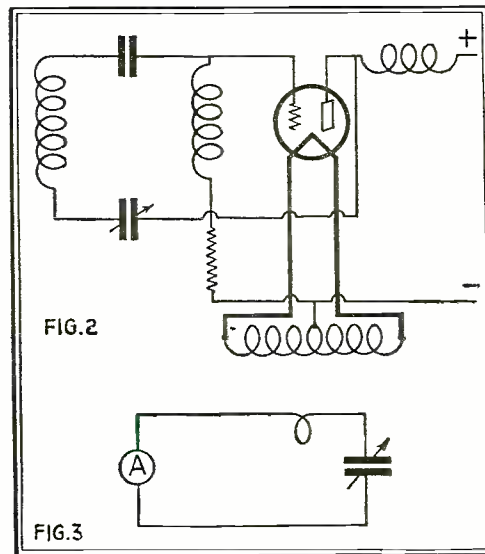

Fig. 1—A conventional short-wave receiver circuit which, with slight changes, can be used at exceedingly high frequencies





Top view of a 10-meter receiver. The compact arrangement permits very short leads, which are essential in the higher frequencies



OSCILLATOR  
FIG. 4

MIDGET  
VARIABLE CONDENSER

FLASHLIGHT  
LAMP & SOCKET

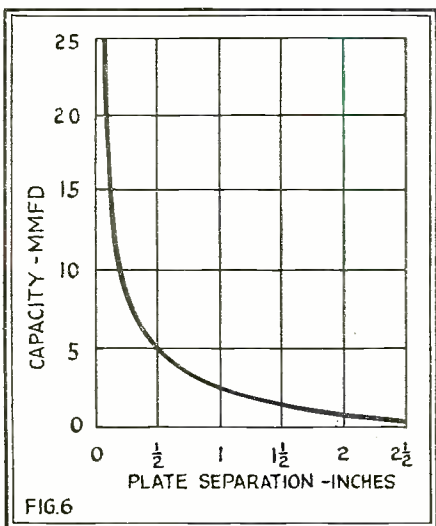

Fig. 4—This 5-meter wavemeter consists of two coils 4 inches in diameter

Fig. 6—This curve illustrates the rapid drop in capacity as the plates of a 4-inch condenser are separated

get a receiver operating with parts close together (to obtain short leads), it will not operate at all. Large variable condensers, with metal end-plates cut down to size, should not be used. A "midget" variable condenser of the proper size (about 2 or 3 plates with greater spacing, giving a maximum capacity of about 10 mmfds.) for the tuning condenser aids greatly.

Aside from the losses described, and certain dielectric losses, a tuned circuit consisting of a small midget-type condenser and a coil has low losses. If a coil of large diameter is used every movement of the body will influence regeneration. The field is large in extent, and changing the circuit losses changes the required feed-back for proper oscillation. "Hand capacity," as such, is nothing to worry about, but if an extremely small tuning condenser is used it may cause trouble.

Another important consideration is mechanical vibration. It is important that no part of the tuned circuit or its leads should vibrate. A vibrating lead can do plenty of tuning itself, when the total circuit constants are already small. If copper tubing is used it can be heated first and then dropped into water; this reduces any such tendency. The detector tube should be cushioned well; otherwise its elements will vibrate, giving the effect of bells for an indefinite period. The usual procedure

with a rubber bath-sponge aids greatly. It follows that flexible leads (say of No. 36 wire) should connect with the tube where possible.

Fig. 2—A transmitter circuit for use in the neighborhood of 60 megacycles  
Fig. 3—A circuit for measuring transmitter output. It employs an antenna ammeter, a single-turn coil and a midget variable condenser

Thirty-megacycle (10-meter) operation should appeal especially to experimenters looking for the unusual, as the equipment is easier to get working. The amateur band here is comparatively wide, and the apparatus is easy to assemble—and often cheaper than that used at lower frequencies. Reflectors are also of convenient size. Apparatus designed for the lower frequencies can be modified easily for operation at 10 meters. In designing a receiver for 10-meter use it is well to remember that the total inductance in the tuned circuit is also small, so the leads should be short. Tubes of high internal capacity should not be used, as they "load" up the oscillating circuit, reducing the L/C ratio, the input voltage and the signal strength. In one receiver several new -99's were tried, and only two oscillated over the same range. It is usually best to select a certain tube and to design the receiver around it. In some cases it may be advantageous not to use a tube socket. The usual purpose of a socket is to provide a convenient means for changing tubes, but at these frequencies different tubes change things so much that very little, if anything, is learned by trying various tubes.

The tube can be mounted near the tuning circuit, and the leads are soldered to the ends of the pins. Holes of the proper sizes, drilled in a bakelite sub-base, can also be used for a "socket." A push-pull receiver employing screen-grid tubes can be used if desired. This arrangement, however, is more complicated and quite expensive in comparison.

If a short-wave receiver which will also operate at 60 mc. is contemplated, it is necessary to design the set for this frequency. If a receiver operates well at 60 mc. results are usually better at the lower frequencies also, as all unnecessary loading effects have been removed. The -12 tube oscillates easily at the highest frequencies, but its internal constants are greater than those of the -99 tube, for example, and correspondingly smaller constants can be used in the tuned circuit. The regenerative circuit employing capacitative control of regeneration, shown in Fig. 1, can be used.

A special receiving antenna for 60 mc. use is not necessary, as has been shown by field tests. The usual amateur antenna of 100 feet or so will serve, although the coupling should be considerably less. A regenerative receiver should be adjusted well removed from the antenna first, and finally coupled to it by means of a turn of No. 14 wire about two inches in diameter. More coupling will prevent proper control of oscillations. For distance work a horizontal antenna will probably operate more effectively, as the polarization of high-frequency waves increases with the frequency; but 5-meter waves, in this respect, are beyond our present knowledge.

The signals from a 5-meter transmitter seem to be somewhat more powerful than those from a similar low-frequency set.



The low-power transmitter shown below was used by Mr. Binneweg in his short-wave experiments. Some of the earliest work on 5 and 10 meters was done at 6BX, the author's station

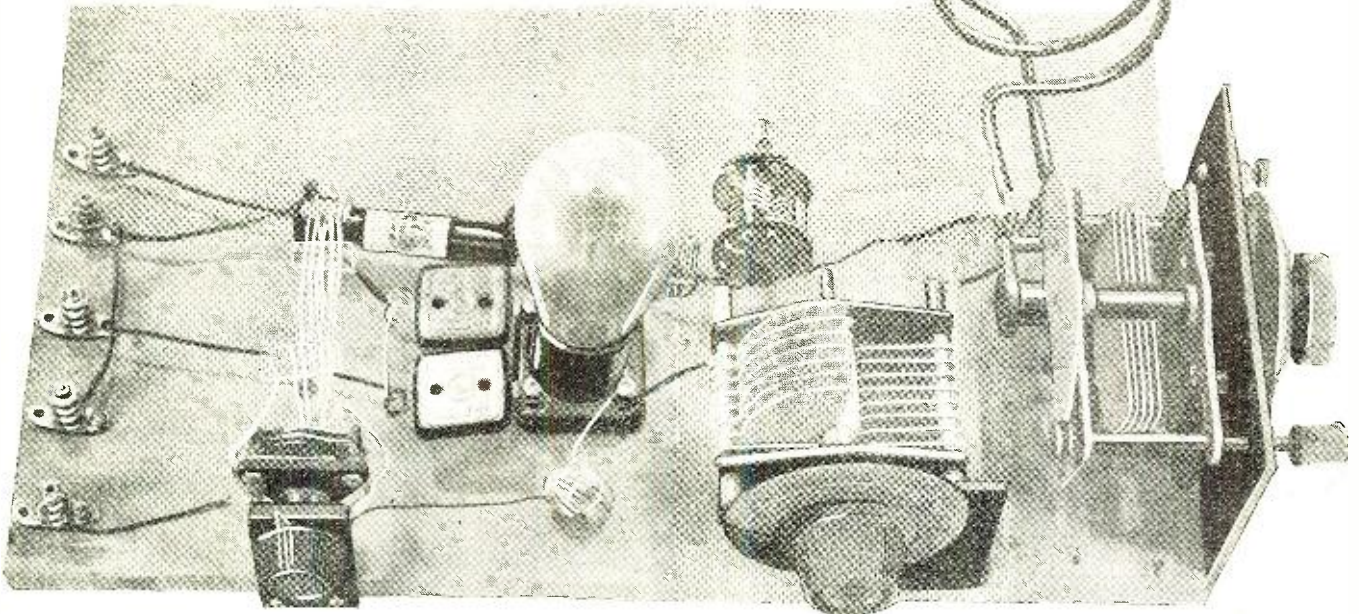

If the detector is provided with a plate milliammeter of the proper range, the wavelength of the transmitter can be determined by tuning the receiver for minimum plate current, if the oscillator is powerful and near the receiver. It is also interesting to see a shorted r.f. ammeter, on a table perhaps twenty or thirty feet from the transmitter, give a half-scale deflection for apparently no reason at all. With its distributed capacity and its inductance, it is probably "tuned" to near 5 meters. The importance of the inductance of such instruments is not noticed until one attempts to connect one of them in series with the antenna. If a "zeppelin" type is used, it is possible to throw it out of proper balance. To tune for resonance it is best to note maximum plate current or minimum grid current in the transmitter.

Another interesting effect noticed in field tests is the definite "shadows" cast by certain objects. An ordinary home, or a small hill, give "not a sound" behind them, whereas the signals just to one side may be all that can be expected. Elaborate transmitting and receiving apparatus is not necessary to study these effects in the field. A simple detector and one stage of audio, mounted on the rear seat of the car, with the batteries on the floor, is the "portable laboratory." An antenna is not especially necessary on either the transmitter or the receiver for distances up to about ten miles, and possibly further.

In certain tests a simple transmitter employing a lone  $7\frac{1}{2}$ -watt tube in the circuit of Fig. 2, without any antenna, gave some interesting results. Every hill, no matter how small, cast a definite radio shadow. Whenever the receiver was in a direct line with the transmitter, and there were no trees or houses intervening, signals were good, but anything in the way "blotted" them out. Of course, the power was small, but the same results were obtained with a 500-watt set, which used a transmitting aerial. The aerial was above the transmitter, and more power was used, so that one would expect the "shadows" to fill in somewhat, which they did. The signals were studied for distances up to 100 miles from the station. Sometimes we heard them, and at other times we did not. In all probability the signals were coming down in some distant land with very good strength, but how were we to tell?

On one occasion a strong 5-meter signal was heard, which upon investigation proved to be only a harmonic of a 40-meter amateur transmitter located about half a mile from the receiver. Harmonics from amateur transmitters operating in other bands are often confusing (to say nothing of the more powerful ones from modern broadcast stations), but a ninth harmonic for a  $7\frac{1}{2}$ -watt set at this very high frequency is unusual. The transmitter was very poorly adjusted, or there were strong parasitic oscillations present. A properly adjusted 250-watt set in the same location gave extremely weak harmonics. It is very im-

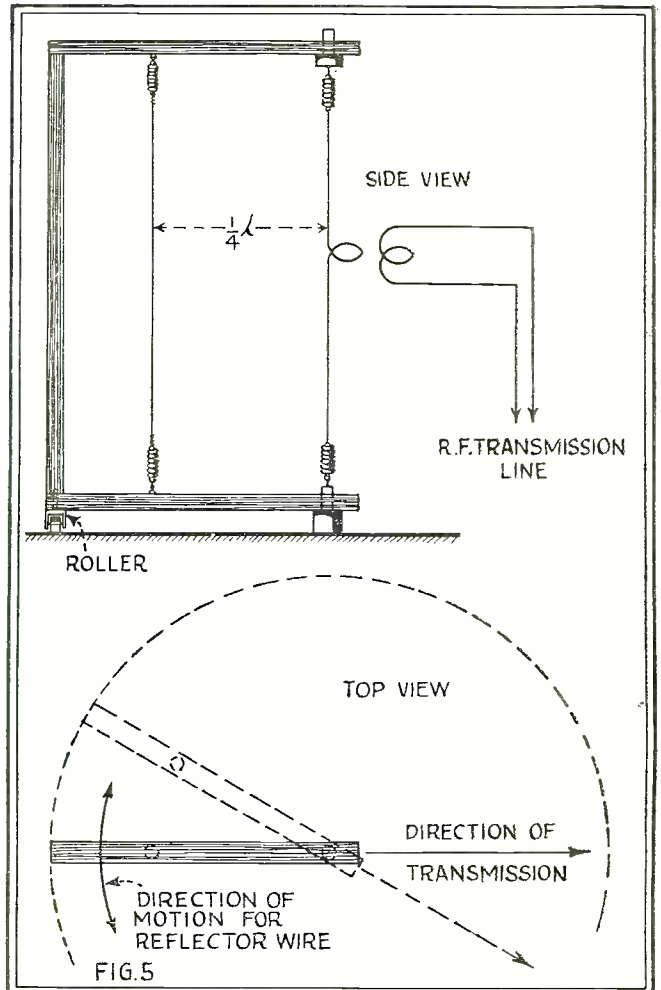
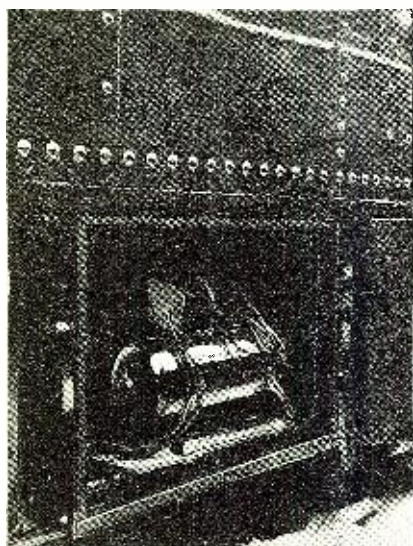
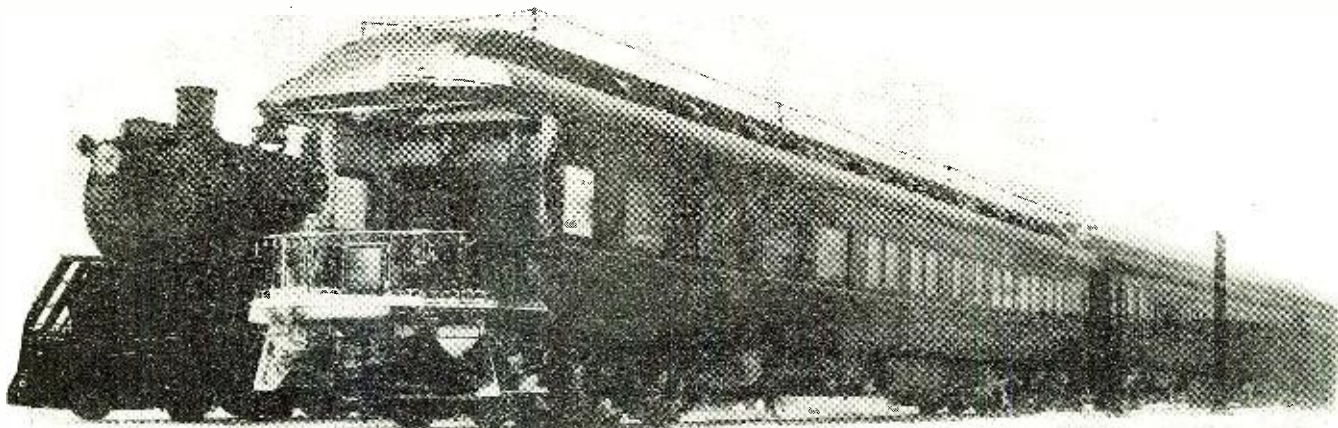

Fig. 5—A practical directional antenna. A single reflector wire is pivoted so that it can be rotated around the transmitting aerial for directional transmission or reception

portant to use a small tuning condenser, otherwise tuning will be extremely sharp and signals (especially d.c. notes) difficult to find and hold. (Continued on page 950)



The roof antenna of a Canadian National Railways pullman



# TUNE IN as You Travel

A motor-generator, slung underneath the coach, supplies current for operating the radio receiver

By W. D. Robb\*

*In 1923 the Canadian National Railways began its pioneer work in the installation of radio for its patrons. Today all its most important trains are equipped with receivers, and a series of broadcasting stations has been erected throughout Canada for the especial purpose of transmitting programs to the trains. The editors believe that this is a most significant development, and have arranged for a series of articles, of which this is the first, detailing the progress of radio in this field, both in Canada and abroad.*

**T**HE recent announcement by the radio department of the Canadian National Railways that a new radio circuit has been put into operation between Edmonton and Vancouver in the west, completing the transcontinental network of the Canadian National System and bringing eastern Canadian programs over the barrier of the Rocky Mountains to Canada's Pacific coast, draws attention once again to the enterprise of this railway in providing radio receiving apparatus as standard equipment on all its through trains and in maintaining thirteen broadcasting stations from one end of Canada to the other. The telegraphic department of the road, working in conjunction with the radio department by carrying programs on its newly installed "carrier current" system, makes possible the broadcasting of programs from the Atlantic to the Pacific without regard for natural obstacles, such as the Canadian Rockies, which are a frequent bar to consistently good reception.

The Canadian National is the only radio hook-up in the world which traverses five time zones—a program broadcast from its most eastern station, CNRA at Moncton, New Brunswick, on its journey westward across the continent to the most western station, CNRV at Vancouver, British Columbia, fring-

\*Vice President in charge of radio, Canadian National Railways.

ing up the Atlantic, Eastern, Central, Mountain and Pacific time areas, and reaching its ultimate destination at the Pacific Coast city four hours before the standard time at which it was sent. In its passage across Canada this program would be picked up in the various parlor and observation cars en route over Canadian National lines. It is estimated that during 1928 these radio-equipped cars traveled a total of 6,100,000 miles in the United States and Canada, providing 63,000 hours of entertainment. Radio has been introduced on the lines of the System operating in the United States, both the Central Vermont and the Grand Trunk carrying parlor and observation cars with the usual loud speaker and alternative headphone equipment, along with a uniformed attendant to operate the set. Only a short time has elapsed since it was announced that the Chicago and New York expresses operated over the Lehigh Valley and Grand Trunk lines between Chicago and New York would be fitted with this same provision in the interest of the traveling public.

With the co-operation of Station WWJ in Detroit many programs of the Canadian National Railways have been transmitted into the United States. Similarly tie-ins with British circuits have enabled the Canadian listener-in to receive over the air such events as the last Cenotaph ceremony on November 11, 1929.

Radio development on the Canadian National Railways had its genesis in the summer of 1923 when a party of Brooklyn newspaper men was making an excursion across Canada on a special train. As a novelty, the railway undertook to broadcast them a message of welcome from the Dominion. The experiment was successful. The Brooklyn journalists received what was probably the first broadcast to a moving train.

A great amount of experimental work was done, however, before the Canadian National Railways reached the position which it holds in the radio world today. As a matter of radio



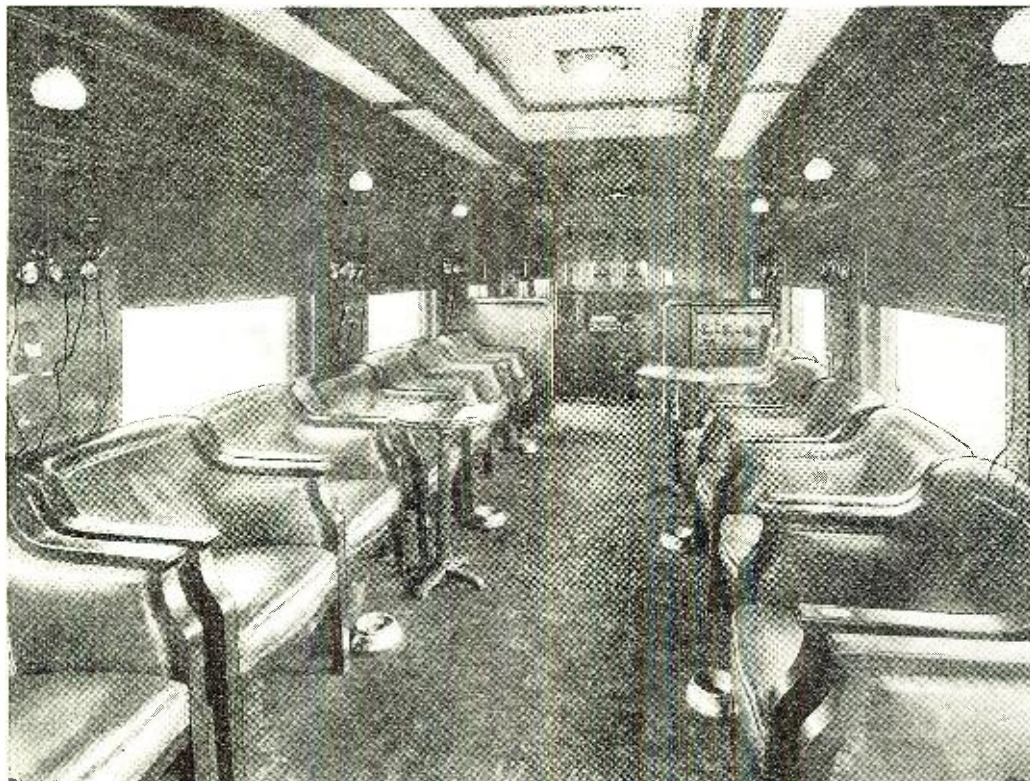

Interior view of a Canadian National Railways car, showing the radio installation. Headphones are available when operation of the loud speaker (above the book case) might disturb others

Another type of installation. A phono-radio combination ensures entertainment for passengers at all times

## *Canadian National Railways keeps abreast of the times by providing radio entertainment for passengers*

history, as far back as October 13, 1902. Sir Ernest Rutherford, a professor at McGill University, transmitted signals by radio to a special train on the Grand Trunk Railway System while it was speeding toward Montreal with the members of the American Association of General Passenger and Ticket Agents. The Grand Trunk System is now part of the Canadian National Railways.

After the experiment with the Brooklyn newspapermen in 1923 Sir Henry Thornton, the American-born president of the Canadian National, gave me the job of developing the new radio department. I gathered about me capable engineers and formulated the general line of policy. We had two main plans on which to work. One was to equip all the trains of the system with receiving sets and the other was to establish broadcasting stations. This was the first time in the history of railroading that radio was made part of the service offered to the traveling public.

On New Year's Eve, 1923, the first regular broadcast of the Canadian National Railways was sent out from a station belonging to another company in Montreal. The next step was the erection of a broadcasting station at Ottawa, Ontario. Their radio chain now includes stations at Moncton, Quebec, Montreal, Ottawa, Toronto (2), London (Ont.), Winnipeg, Regina, Saskatoon, Calgary, Edmonton, Red Deer and Vancouver.

When the question of call letters for the Canadian National stations came up it was found that the letters CNR had been allotted to Morocco. The Canadian Government enlisted the aid of the British Foreign Office, which appealed to the French Government and after some diplomatic correspondence Morocco relinquished the call letters CNR in favor of the Canadian National Railways. These call letters are now CNR with the initial of the city in which the station is situated added.

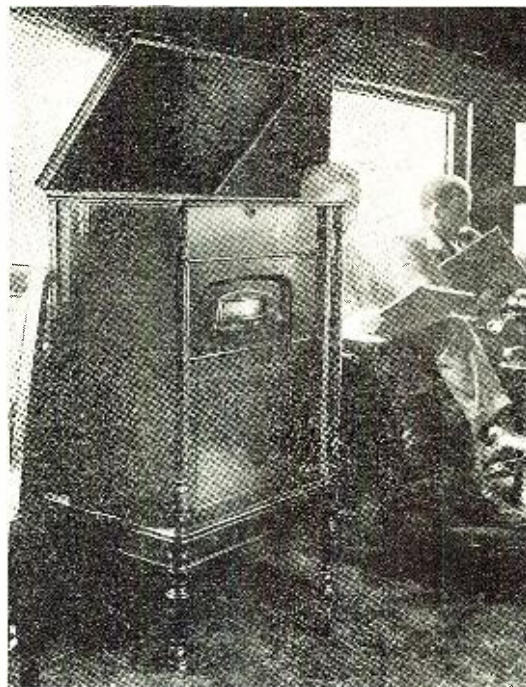

Thus, CNRM is the system's broadcasting station at Montreal. The station at Moncton, its call letters being CNRA, and CNRX, a new addition to the chain at Toronto, are the only exceptions.

While the work of establishing broadcasting stations went on the trains were not being neglected. The radio engineers had trouble at first in securing the types of sets necessary for successfully receiving concerts on board a moving train, but this difficulty has been overcome and to date all of the important trains of the system, such as the Continental Limited, have been equipped with radio. The Canadian National are now installing on all radio-equipped cars the latest type of a.c. receivers with dynamic loud speakers. The transcontinental service and on the runs between Montreal-Boston, Montreal-Halifax and Toronto-Winnipeg they are installing combination radio and phonograph, so that radio programs can be supplemented with recorded entertainment at points along the right-of-way where it is not possible (*Continued on page 949*)



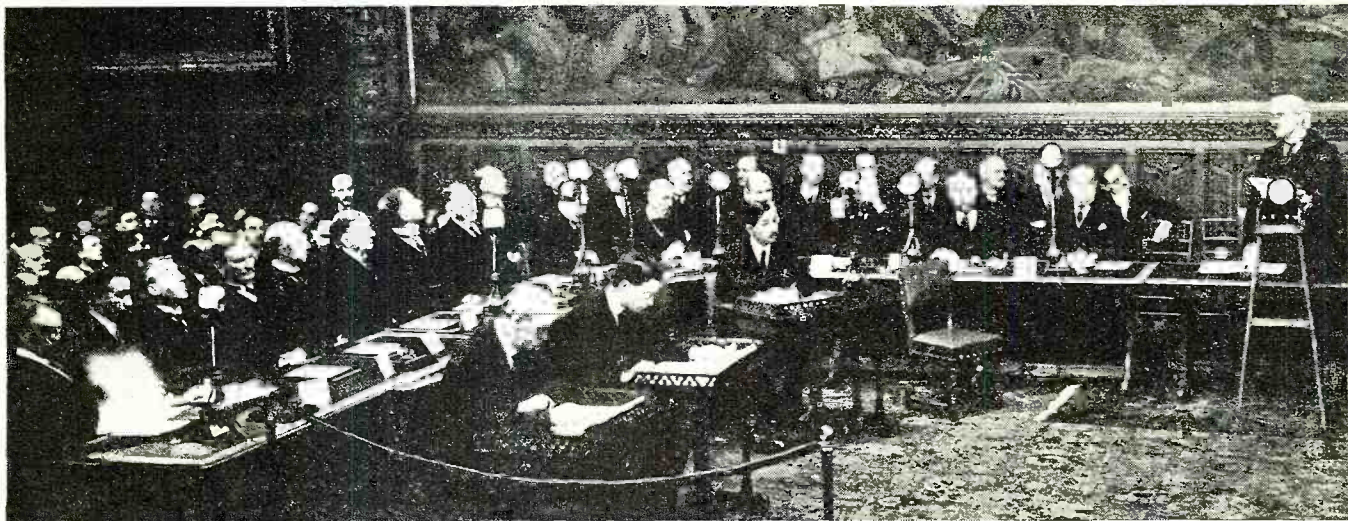

Premier Ramsay MacDonald speaking into a microphone in the Royal Gallery of the House of Lords, on the opening day of the Five-Power Naval Conference. His address was heard 'round the world

# Current

By STUART C.

ONE of the greatest and most significant triumphs in the history of radio occurred on the morning of January 21st when the address of King George V of England, opening the Five-Power Naval Conference in London, was carried to the world at large over a globe-girdling network of air waves and wires—a crowning achievement, majestic in scope and epochal in the linking together of nations in a manner hitherto impossible.

In this erasure of space strange tricks were played with man-made time. Tokio tuned in at 8 p. m., while New Yorkers arose at 6 a. m. to listen simultaneously to words spoken in London at 11 a. m. The mariner approaching the international date line might have heard King George's well modulated accents on the evening before they were uttered, and six minutes later listened to the conclusion of the speech on the evening after. But the scientific feat of the greatest of all international broadcasts, to date, inspiring as it is, is merged in the hope which it suggests of carrying the spirit of friendship across the boundaries of land and sea, from nation to nation, by bringing whole populations in audible presence at the seat of peaceful council.

Pickup of the proceedings at the conference was arranged by the British Broadcasting Corporation, which also put them on the air from the G5SW station. The National Broadcasting Company picked up the signals at its Riverhead, Long Island receiving station, whence they were transmitted by telephone wire to the control-room in New York City. From this point they were distributed to fifty-nine stations throughout the country.

The Columbia Broadcasting System received its program

through the shortwave Transatlantic telephone station of the British Post Office, at Rugby, England. It was picked up in the United States by the low-wave station at Netcong, N. J., otherwise used for the trans-oceanic telephone circuit by the American Telephone and Telegraph Company. Telephone wires brought the messages to the New York studios where they were distributed to the network stations.

Undoubtedly this event brought together the greatest audience ever assembled to listen to the same program, a fact alone that makes January 21st red-letter day in the history of radio.

## Home Radio Talkies

Home radio talkies, or synchronized sight and sound broadcasting, left the laboratory in commercial form only a short time ago and for the first time have been demonstrated before the public.

That the exhibition was not so much a technical advance as it was a practical exhibition, was emphasized by D. E. Replogle of the Jenkins Television Corporation.

The radio-talkie program for this demonstration was broadcast simultaneously through two stations; W2XCR

which, transmitted from sound films, and W2XCD which broadcast the silent films run through the television pick-up apparatus.

At the receiving end, two separate and distinct radio

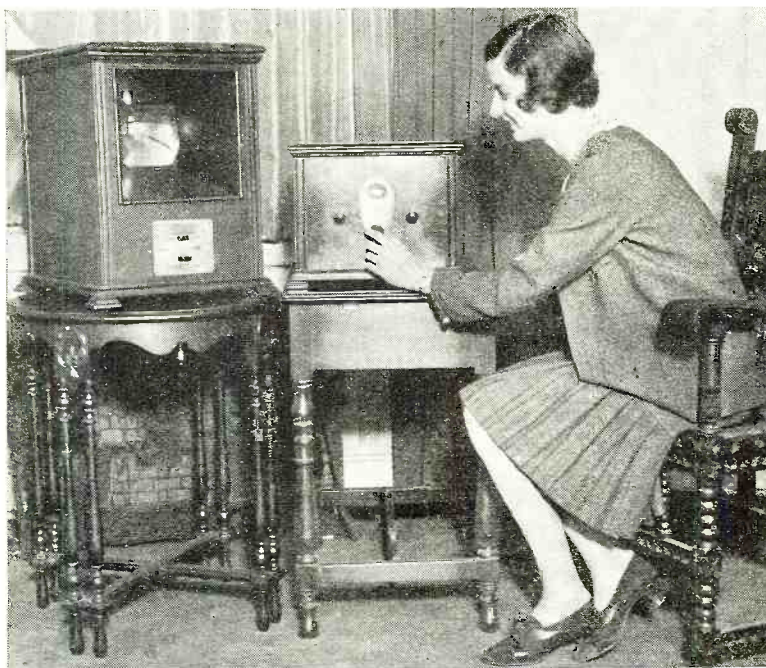

The first commercial home television receiver for tuning in talking motion pictures. Much developmental work remains to be done, but public demonstrations of this apparatus indicate that much may be expected of it in the future





Fourteen microphones were provided for the twenty-eight delegates to the Conference, while fourteen loud speakers in the conference chamber insured even distribution of the speaker's voice

# Comment

MAHANAY

receivers were employed. One, a special broadcast receiver to tune in the signals of Station W2XCD on 187 meters and a Jenkins short-wave receiver, covering the 100-150 meter band. The latter, tuned in the signals of W2XCR.

The Jenkins officials made clear that better pictures have already been shown to the public and press by highly developed laboratory equipment of a very special character, but this first demonstration was made under typical, everyday conditions, with equipment that can be bought for the average home in those areas served by the same electric power system.

## Bungling Boston

There recently appeared in the *Boston Post* an announcement that George A. Parker, Registrar of Motor Vehicles, was planning to issue regulations prohibiting the operation of motor vehicles on the highways of Massachusetts if such vehicles were equipped with radio receivers designed for broadcast reception. This announcement prompted the following letter, which is self-explanatory:

MACKINNON-FLY PUBLICATIONS, INC.

January 30, 1930.

Mr. George A. Parker,  
Registrar of Motor Vehicles,  
State House,  
Boston, Mass.

Dear Sir: One of our good friends has sent us a clipping from a Boston paper indicating your ruling concerning the use of radio receiving equipment in automobiles. You are quoted as making the following statement:

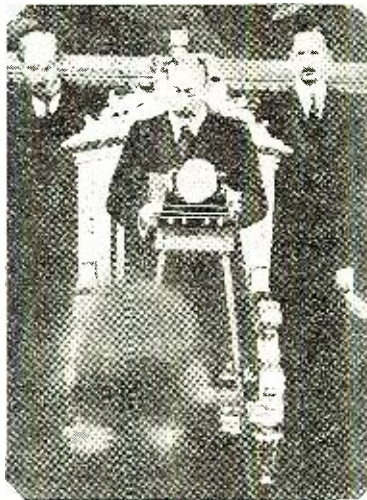

King George opened the Naval Conference with an address which radio carried to all parts of the earth. (Right) The special gold and silver cased microphone for the exclusive use of His Majesty



"Radio certainly does interfere with the operation of an automobile. I know, because I have ridden in a car with a radio in operation. It is clearly a mental interference and I will not permit them in this State."

There may be some folks in Massachusetts who will disagree with you. May I call your attention to the report of a meeting which I called in New York on November 14th, to discuss with the leaders in the automobile and radio manufacturing industries, the advisability of automobile radio receivers. That meeting was attended by a great many executives from all over the country and I call your attention in particular to the following list of names from corporations in your own fair State:

Mr. G. Frederick Petry, Sales Engineer, Mershon Condenser Division, Amrad Corporation, Medford Hillside, Mass.; Mr. F. W. Marsh, President of The Champion Radio Works, Danvers, Mass.; Mr. C. Howard Baker, Asst. Sales Manager of the Radio Division, American Bosch Magneto Corp., Springfield, Mass.; The National Company of Malden, Mass., was represented by Mr. A. E. Stevens, Manager of the National Company's New York sales office; The Radio Manufacturers' Association, of which Mr. H. B. Richmond, who is General Manager of the General Radio Corporation of Cambridge, Mass., also the President, was represented by Mr. Geddes, the New York Resident Manager and Vice-President of the Association.

I believe you will agree that this is rather a formidable group of folks coming from your own section of the country and that it is unlikely that representative people of this character would seriously contemplate engaging in any sort of a business enterprise which could, by the wildest stretch of the imagination, be considered to be injurious to the man in the street.

May I call to your attention the fact that several New England companies have spent a considerable amount of money and a great deal of time in the (Continued on page 949)



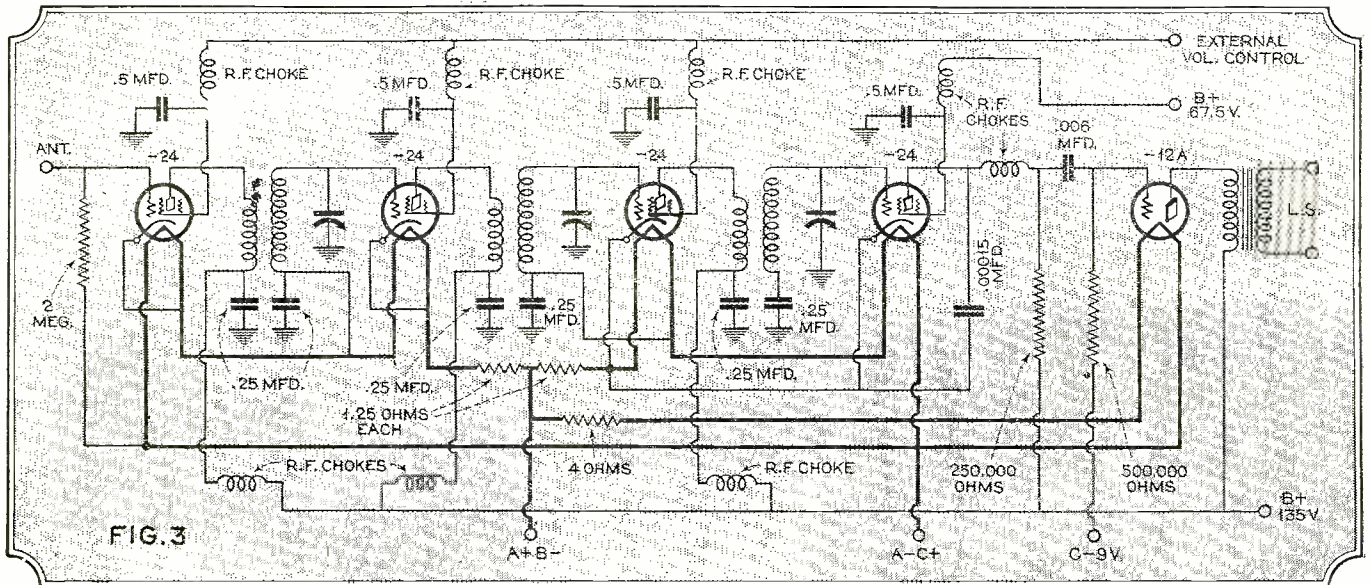

Like most auto-radio circuits, the one shown above makes use of -24 type tubes in a d.c. circuit for greater stability in operation, less noise being produced because of the sturdier construction and indirect heating features of the -24 tube. Note that only one audio stage is employed

# A Universal AUTO-RADIO Receiver

*A discussion of problems influencing the design of  
an outfit that may be installed in any car*

THE New York Automobile Show, held at Grand Central Palace in January, served,

By Walter H. Bullock

the ground, it might be a fair energy collector, but, since this effective or useful height is determined more by

among other things, to eliminate any doubt in the minds of skeptics as to the field for radio with the motorist. At that exhibition no less than six well-known automobile lines were displayed in which the cars were fitted for radio, with the instruments optionally supplied, at an additional cost of less than two hundred dollars. Not only was it significant to note the recognition of radio by the motor-car manufacturers themselves, but the interest shown by the visitors clearly indicated that the automobile manufacturers had struck a popular chord.

Since publishing some of our earlier articles on radio for the automobile, it has been our desire to develop a high-grade radio receiver that would be adaptable to any car regardless of make, quality or age. The matter has been the subject of considerable attention and study during the past few months, and we believe that we have now worked out an outfit that, when all things are considered, will be difficult to improve to any great extent, with the tubes and standard parts now available. Having as an aim the highest quality outfit for the purpose, it was necessary for us to discard tradition very largely, and to study the automobile and its operation most carefully before proceeding to lay out the set itself. In doing this, we naturally discovered a number of problems with which we do not ordinarily have to contend, and our methods of solving them have resulted in a radio receiver quite unlike those common to the radio broadcast field.

In the first place, the limited height of the automobile and the fact that the greater part of its body is of metallic construction meant that it would be impossible to employ an antenna with an effective height sufficient to obtain a very appreciable pick-up of radio energy. If the effective height of the automobile antenna were equivalent to its physical elevation from

the vertical distance between the antenna and the metallic body, its poor efficiency is not surprising. A loop antenna might possibly be employed, but due to the many disadvantages of an installation of this sort the coil antenna is not particularly appealing. It would not only be difficult to install, but its characteristics would vary for different installations; it would practically necessitate a two-dial receiver, and its directional characteristics would be objectionable. A loop in a horizontal plane in the top of the car or around the inside of the body has been suggested to eliminate the directional objection, but it would still be subject to practically all of the other objections, and would be less efficient than similar coils in vertical planes because of the less favorable angle at which the advancing electromagnetic wave would cut the conductors. Consequently, as far as we can see, the open type of antenna system is the most practicable arrangement to employ.

Obviously, the metal structure of the machine has to serve as a ground connection—or call it counterpoise, if you will—and the antenna will consist of a network of conductors insulated from the frame. There are comparatively few possible variations in an open type aerial, and in most cases it will start with a conductor running from the set, as nearly vertical as possible, to the highest point on the machine, where other conductors can be spread out horizontally. These conductors may be in the form of a copper mesh under the covering of the top, or they may consist of a number of wires running backward and forward or around the top, either inside the covering under the leather trimming tape or on the interior of the machine.

With this consideration of the antenna problem, we find that, because of the small effective height of the aerial, we cannot



An auto receiver must be compact. Space in a car is at a premium and receiver design must be governed by this predominant factor. Ruggedly constructed, the auto set described here follows closely this important design feature, as is well illustrated below

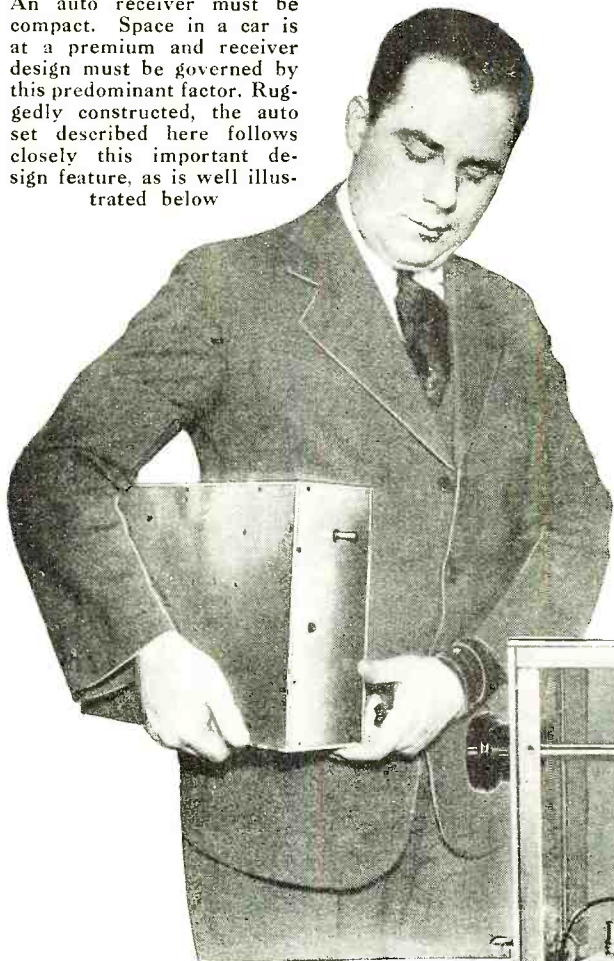

Inside view of the auto receiver. Shielded compartments isolating each of the tuned stages insures stability. The power tube, removed from its socket, is located in the audio amplifier compartment

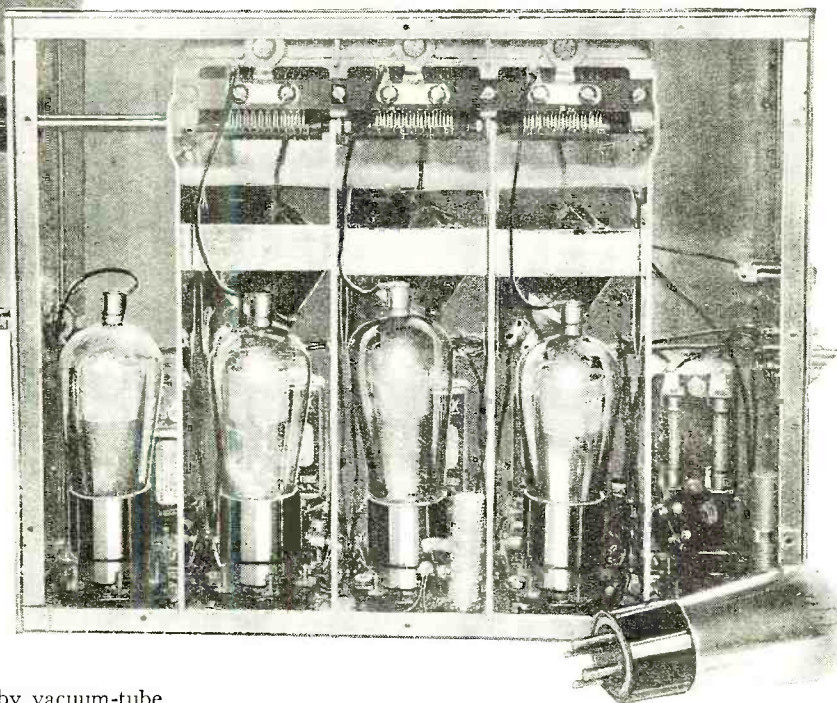

obtain a signal pick-up of the degree with which we are accustomed to deal, and, therefore, in building our set we must make up for this deficiency by increasing the radio-frequency amplification of the outfit to a corresponding extent. The high-frequency end of the set is, consequently, the next subject to study, but it is so completely governed by vacuum-tube characteristics that we will first have to consider the types best suited for automobile use.

Among the chief factors that are to determine the tube selection is the matter of availability, which it is wise to consider in the design of any piece of apparatus intended for use over any appreciable length of time. However, this does not impose any great restrictions, for there are a variety of readily obtainable tubes which, in all probability, can be purchased in the open market for several years to come. The second condition to satisfy is the comparatively great vibration encountered in the operation of a car. This calls for tubes of a structure that provides rigid support of the elements, and a separation between them that will prevent shorts when subjected to heavy jolts. The filament must be of fairly heavy cross-section if unipotential cathodes are not used, although the latter type would obviously be preferable. These requirements definitely eliminate tubes of the -99 and -22 types, unless measures are taken to shock-proof the tubes, or set as a whole.

The filament supply is another item. Since the most practicable arrangement is to employ the starting battery for the A circuit, its potential variation of from about 6 to  $7\frac{1}{2}$  volts (depending upon the state of charge of the battery and the speed of the car) must be taken into account, as well as the danger of discharging it to a point where it will not satisfactorily serve the car's starter, ignition, lights and other electrical accessories. Because of its direct current, we cannot alter its

voltage in the convenient manner in which we obtain various potentials in our a.c. power supply units. We must, therefore, strive to employ as few tubes as possible, those that will stand up under these current variations, and preferably those that have filament or heater characteristics that require little or no resistance in series with the storage battery. If this condition alone were to be considered, we would probably use 5-6 volt tubes of the thoriated filament variety.

The plate supply is practically as important as the source of filament current, for it is desirable to employ as few and as small B battery units as possible. Good 45-volt B batteries are expensive and heavy, and require considerable space. Since power tubes are the greatest consumers of plate supply energy, we must select a type that will work well on a reasonable voltage as well as a moderate current drain. Unfortunately, in this class we have no rugged unipotential cathode tubes to consider. Of the filament types, -01A's are out of the question as last-stage amplifiers, since we have now learned to expect such quality from a radio set that we cannot tolerate the distortion brought about by their overloading. Next, in order of their size, are the -12A and -71A. Both make the same filament supply demands, and either will perform satisfactorily on 135 volts of B battery or three standard 45-volt units. Other power tubes require voltages so high that they cannot possibly be con-

sidered until some progressive manufacturer brings out a dynamotor with sufficiently high d.c. potentials to take care of their plate circuits. On the other hand, it is questionable if larger tubes will be necessary to supply all of the volume that can be enjoyed in the comparatively limited space of an automobile. This practically narrows the choice down to the -12A and -71A. The latter will handle stronger signals without distortion, but, due to its lower amplification, it requires greater audio-frequency step-up before it. As this might mean the use of an additional tube and associated units, the -12A with its greater amplification is surely attractive, and we believe its lower output will be ample for the purpose at hand.

Assuming that the type of output tube is now determined, we next consider the audio amplification necessary to supply this tube with the input necessary to obtain a satisfactory volume of sound from the loud speaker. Ordinarily, we would say that one other stage would be required, but it has been demonstrated that where good radio-frequency amplification is employed and a screen-grid tube is used as a detector, coupling may be made direct from the plate circuit of this tube to the input of the power tube without the necessity of an intermediate stage of audio amplification.

Because of the very high amplification available in screen-grid tubes, fewer of them would be required to provide a given signal voltage than would be necessary if three-element tubes



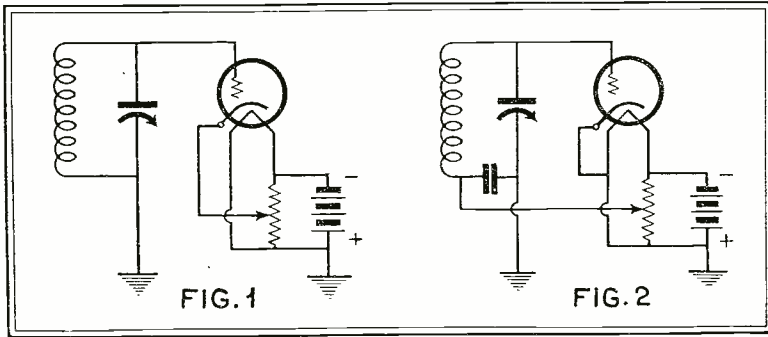

Obtaining the proper value of bias for the screen-grid tube is, indeed, a problem. Two methods are shown above, Fig. 2 being the preferable, since then the polarity of the battery "ground" is not important

were used. By their use we can save at least one tube in the radio-frequency bank. To be sure, their A battery demands are greater than -01A's, but because of the structural weaknesses that might result in microphonic noises or damage to filament tubes, we would probably consider the -27 as the only alternative for the -24 cathode screen grid. The -27 has exactly the same heater characteristics as the a.c. screen grid, giving neither the advantage on that score. On the other hand, the -24 gains a point beyond its superior amplification qualities by drawing only about one-third the current from the B battery. As we go over the tubes and the conditions that they are required to meet, this particular type seems to surpass all others in every way except, possibly, the fulfilment of its A battery demands. But as none of the tubes that operate with less filament circuit energy have as many advantages for automobile use, it would seem that the -24 offers much for the price paid in storage battery amperes. For home use, we would probably employ but one or two of these tubes because the energy delivered by the fairly efficient aerial to the first tube would undoubtedly be as great as that furnished by the output of a one-stage amplifier coupled to the poorer automobile antenna. For the average home and motor-car installations this comparison is approximately true, and thus we will require three stages of radio-frequency amplification to compensate for the poor energy-absorbing qualities of the smaller aerial.

By following this line of reasoning, we have concluded that a set made up of four -24's and a -12A (all but one of these heater-cathode tubes) offers the highest ratio of advantages to disadvantages for vacuum tubes in automobile radio sets. However, the success of other combinations in commercial and home-built sets clearly demonstrates that our present selection is not the only one capable of rendering satisfactory service.

**Mechanical Features**

Having selected the number and types of tubes, we have the backbone around which to add and arrange the cooperating parts and circuits. It is desirable to keep the dimensions of the set as small as practicable, since it frequently happens that the smallest space is the most acceptable location for the outfit. If a set is small enough it can be mounted directly behind the car's instrument board, in which position it is possible to employ directly connected controls. In most of the other possible locations size is of less importance, although the smaller the set is the easier it is to handle.

To attain the minimum in physical dimensions we should select the smallest standard parts and arrange them, first, with regard to short leads, and secondly for compactness. In many cases this means the preference of unmounted units, since there is little use in making

up a new set of individually completed units. For instance, if our receiver is to be divided into shielded compartments there is little point in having it include parts that are themselves shielded. The use of brackets and subpanels is frequently a cause of waste space—or rather of an increase in the size of the set. Some designs use up an appreciable amount of space by employing a flexibly suspended tube panel upon which the tube sockets are rigidly mounted. This construction undoubtedly gives the necessary protection to the tubes when they are subjected to heavy jolts, but the same protection may be had by mounting certain commercially available flexible sockets on a rigid base. The latter have the added advantages of requiring no space for the swinging of a comparatively heavy tube panel, of allowing each tube to swing independently of the rest, of avoiding the use of flexible electrical connections to the socket and of simplifying construction of the set.

Unfortunately this matter of compactness is not as simple as though it were a mechanical problem, for we not only have the problem of arranging the components of the instrument in compact form, but we find that in doing so we have greatly multiplied the difficulties due to undesirable electrical coupling between circuits. With the high degree of radio-frequency amplification employed and the number of stages used, the electro-static and electro-magnetic fields, if visible, would probably look much like a fire in a box of pinwheels. Fortunately, with screen-grid tubes, we need no neutralizing condensers for counteracting the capacitative coupling between the tube elements. All of our cases of undesirable coupling are out in the open, or comparatively so.

**Shielding**

As a first step, the entire outfit must be enclosed in a metallic shield to keep all parts from exerting any external influence or from being affected by external influences. With the exception of the antenna lead, which is the only path by which radio energy should reach the receiver, all but filament connections must include choke-coil-condenser combinations of characteristics suitable for preventing the radio-frequency current from traveling outside the case. More specifically, each stage must be so equipped to avoid interstage coupling as well.

Needless to say, the components of each stage must necessarily be electro-statically shielded from each other. In grouping the units for this electrical isolation, the radio-frequency transformer is enclosed in the compartment of the tube whose grid it supplies rather than in that of the tube whose plate is connected to it. It is well worth while to make the shielding as nearly airtight as possible. Even then coupling is sometimes effected through thick aluminum or a number of sheets of brass. Naturally, this is of an electro-magnetic character, as can be shown by the use of an exploring coil around such a shielded case. With three-element tubes, brass, copper or aluminum shields usually suffice, but with three stages of screen-grid radio-frequency amplification 3/32 inch aluminum is found to be insufficient to care for the coupling in the closely arranged motor-car set. However, No. 24 B. & S. gauge sheet iron, completely or even partially surrounding the tuning inductances, overcomes the difficulty and makes the compact arrangement thoroughly practicable. These shields, or rather magnetic paths, must all be of the same size and similarly disposed to their respective coils, in order that each circuit may be affected to the same degree, and thereby kept in resonance.

Not all cars have the same size of the storage battery connected to the (Continued on page 960)

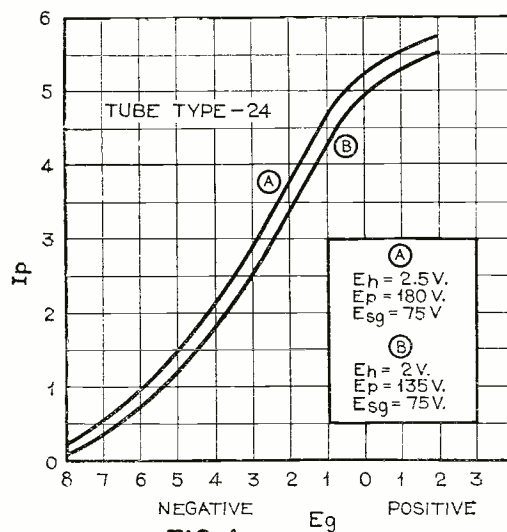
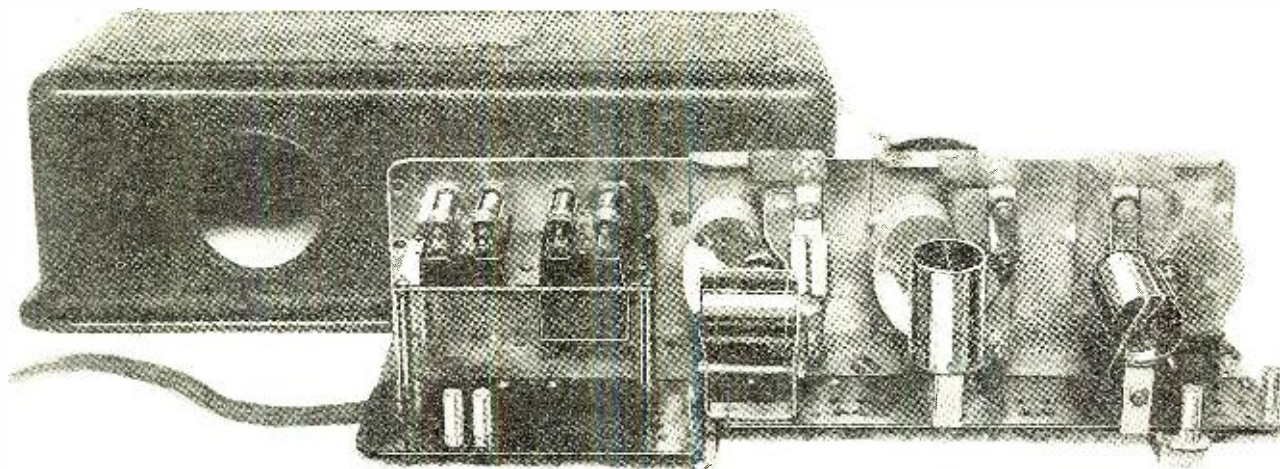

FIG. 4 These curves indicate that little or no loss in efficiency is experienced when the tubes are operated below normal voltage values—a condition which sometimes obtains when the automobile battery is not fully charged





You can easily revamp an Atwater Kent receiver for auto-radio use by replacing the transformer audio channel with a screen-grid resistance-coupled audio amplifier

## A Rebuilt Broadcast Receiver for Automobile Use

*At small cost, you can experiment with radio for your car by making the few simple changes outlined here*

*By John B. Brennan, Jr.*

“**R**ADIO for your car?” you ask yourself. “Well . . . maybe yes, maybe no. Other questions concerning price, ease of installation, and dependability of operation will naturally present themselves in quick order.”

“How much will an auto-radio receiver cost me?” “Can I install the set in my car without inconveniencing myself or passengers, or in any way impairing the normal uses to which the car is put?” “Once installed, what kind of results will I get? Are they worth the trouble?”

The answer is “take a chance—see for yourself—and be agreeably surprised.” Auto-radio is here to stay. Not only are leading automobile and ignition concerns such as Cadillac, Dodge, Delco-Remy and General Motors making auto-radio installation in their cars optional with the purchasers but many independent radio concerns are furnishing complete sets, or kits from which auto-radio receivers may be assembled.

So that readers of RADIO NEWS might take a chance, so to speak, and become convinced, the Technical Staff has labored and brought forth a compact, inexpensive and satisfactory performing auto-radio receiver.

Early in our work the question presented itself. “Should the set be completely built and wired from standard parts, to fit a predetermined design or are there available receivers which, with slight revamping, can be made to fill the bill?”

Building a complete set from the ground up had its advantages. It could be built compactly, it could employ the type of circuit which by test had been found to give best results, and it could be built to employ tubes giving maximum gain under adverse conditions.

Yet, in spite of all this, it was argued, if a manufactured set was available which had the outstanding advantage of being inexpensive, then it would be well to give some

This shows the new audio end of the receiver. The transformers have been removed and the shelf holding the resistance amplifier mounted in their place

thought to the use of such a receiver, altering it to fit in with our special requirements—requirements which use in a car imposes and which are vastly different from those which hold when the set is used in the home.

A fine-tooth combing of the market for such a set produced this rather interesting observation. The Atwater Kent radio receiver, model 35, was available, its initial cost was not great, it was compact, rugged, employed single control tuning and did not require too many tubes for satisfactory automobile operation. Being a model which has since been superseded by others in the Atwater Kent line, it was possible

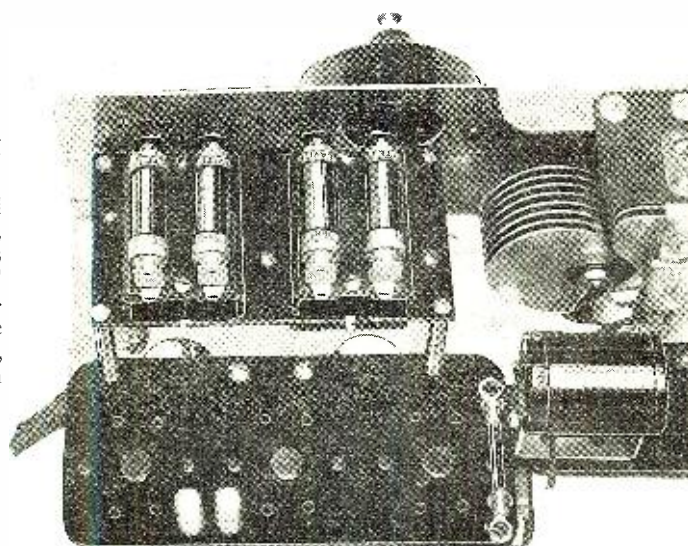



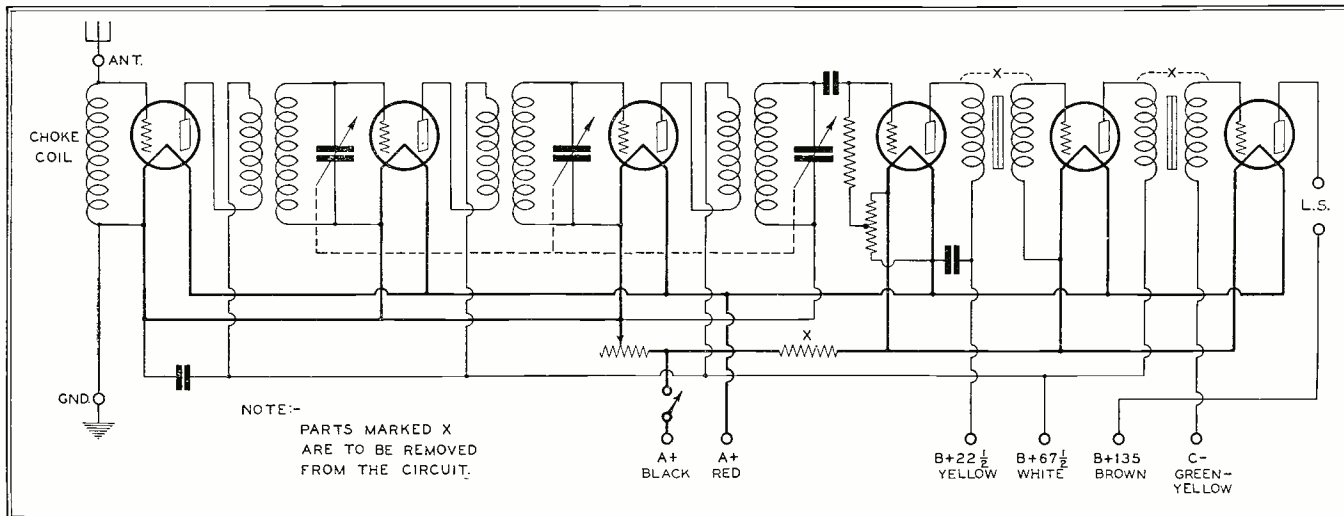
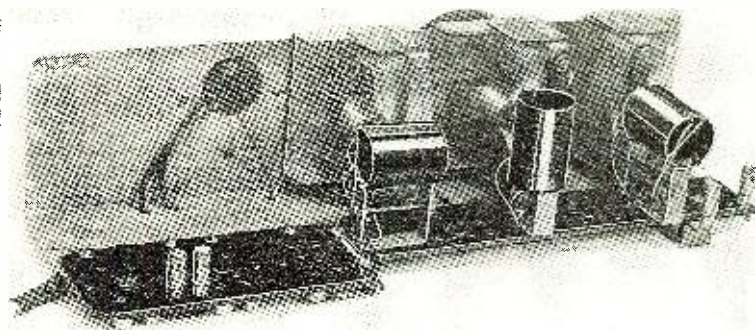

Fig. 1 shows original AK-35 receiver circuit which consists of a coupling stage, two tuned r.f. stages, a detector and two transformer-coupled audio amplifier stages. Those parts which are marked "X" are to be removed from the circuit

Removal of the audio transformers which are held to the base by four machine screws is a simple job. The wires to the filament switch and rheostat are also removed and reconnected outside the chassis



to buy one of these receivers for the insignificant cash sum of \$8.95.

This receiver employs six tubes of the battery-operated type. The first is used as a coupling medium between the antenna and the tuned r.f. stages, of which there are two. Next, comes a tuned, non-regenerative detector followed by two stages of transformer-coupled audio-frequency amplification. The set is compact to the nth degree, being probably the smallest manufactured receiver housing six tubes. It is rugged. Mounted in a metal can, the chassis is well protected, the whole lending itself admirably to mounting in an automobile. All in all the receiver could hardly be better suited for the purpose, if it had been designed just for such use.

From the standpoint of quality of reproduction undoubtedly there is room for improvement and surprisingly, at small cost.

To make our receiver operate with the right kind of quality, we ripped out the two antiquated audio transformers and substituted a single stage of screen-grid resistance-coupled audio-frequency amplification. With this rejuvenation the set performed remarkably well.

In Fig. 1 is shown the circuit of the receiver, B C. (before the change). The rheostat controls only the r.f. stages and is used as a volume control. A fixed resistance in series with the detector and audio amplifier tubes cuts down the applied battery voltage to the five volts required by the filaments for satisfactory operation. Each of the parts which are to be removed from the circuit are marked with an "X." Care should be exercised in removing these parts to clip off their connecting wires as close to the part as possible so that connection may easily be made to these wires in the revised circuit.

Next, in the order of procedure, is the preparation of a shelf, made of bakelite, to support the resistance-coupling units, by-pass condensers and new filament resistors.

Fig. 3 shows the details of construction of this shelf. It is supported from the frame of the set by four brass studs, the forward two, or those near the front panel, being slightly longer than the rear two. These latter supports are fastened to the chassis by removing two of the screws which hold the tube socket shelf to the chassis, and then reassembling with longer, 6/32 machine screws which firmly bind all three, the chassis, tube shelf and shelf supports.

When the shelf has been prepared and assembled, according to the several accompanying illustrations, the wiring of the set may be attempted. In Fig. 2 is shown the new circuit diagram. Note that only the audio end differs from the original circuit. By the use of the screen-grid resistance-

coupled audio stage, which replaces the old transformer-coupled stage of dubious tone range, the audio quality is greatly improved and at no sacrifice in volume, as might first be thought to be associated with only a single resistance stage.

In this stage, a type -22 tube is used, employing 135 volts on the plate and 22 1/2 volts positive bias on the screen-grid. These values are not arbitrary and may require slight change. With the use of this tube, it is necessary to use separate filament resistors for the detector and both audio tubes. For the detector and final audio stage, which employs a -12A tube, 4-ohm resistors are used in their positive filament legs. For the screen-grid tube, a 20-ohm resistor cuts down the 6 volts to the necessary 3.3 volts.

In wiring the receiver for the new audio channel follow closely the circuit details shown in Fig. 2.

After this, the chassis may be re-inserted in the protective metal case and attention given to the problem of installing the set in the car. In most every instance this is a job to be solved by each individual car owner. Of course, a few general rules can be laid down but in most cases each installation will require its own particular solution.

The set may be mounted on the dash, behind the dash, under the driver's seat or on the floorboards. The batteries may be housed underneath the floorboards under the seats, forward of the dash or in any convenient place . . . of which there are not many.

Antenna location and spark plug interference elimination are problems which also require solution and are dealt with in complete fashion in other auto-radio articles appearing in this issue of RADIO NEWS.

The changes in the AK-35 receiver which are recommended here particularly for automobile use, are applicable also to other compact receivers, especially the other A.K. receivers which are similar in construction. These changes are merely a few of those which can be made for the purpose of adapting the receiver to auto use. Others which might be experimented with are the changeover to screen-grid tubes in the r.f. stages, rewiring the primaries of the r.f. transformers so as to obtain sufficient impedance in the plate circuit, and the use of a -27 or -22 tube as a power detector.

After all is said and done, you have taken a chance, at not



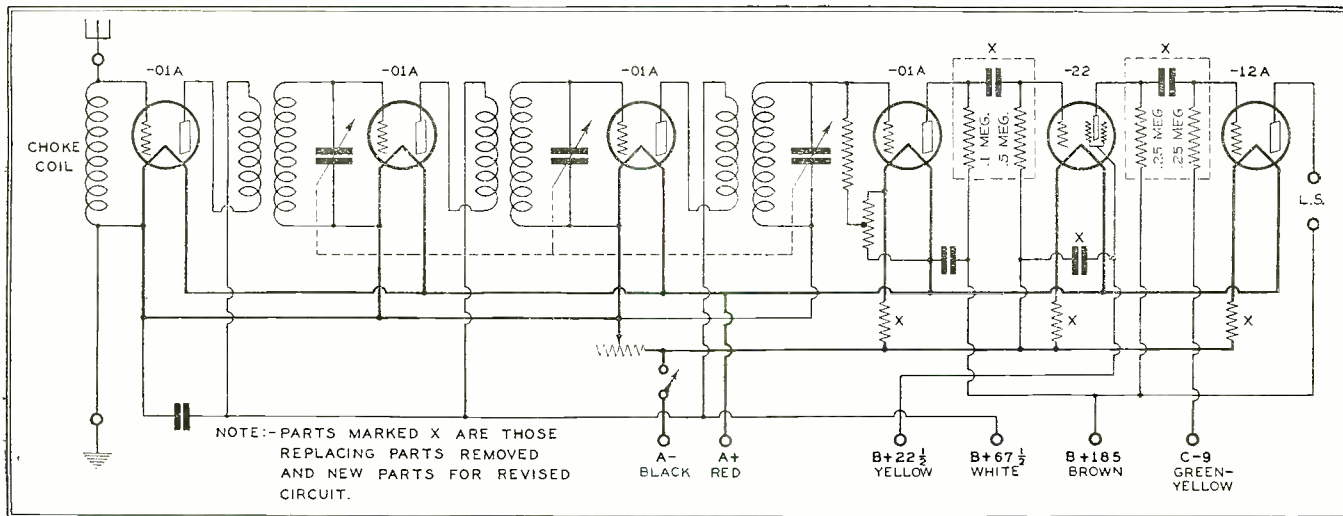

Fig. 2. The new circuit differs from the original only in the audio channel. Here have been added two resistance-coupled units, new filament resistors and a by-pass condenser

too great an expense, you have a workable auto-radio receiver and you are permitted to listen to your favorite program as you travel along.

Once the changes in the receiver are completed it would be well, before attempting to install it in the car, to make a thorough test of its operating qualities especially in respect to its pickup properties. Remember that the conditions under which any radio receiver operates in a car are far different from the conditions which hold when you are operating the receiver at home. The greatest difference, of course, is in the length of the antenna. In a car, the story is quite different. First, the actual size of the antenna is very much limited. Secondly, its height is not great, especially so when you consider that its effective height depends upon the relation of the position of the antenna to the body of the car, which is usually metal. Thirdly, the plane of the antenna changes every time you turn the corner. Some very interest-

ing effects have been noted in this respect and they form the basis of a special study of the problem. Fourth, some care and patience must be exercised in properly housing and insulating the antenna so as to make it as efficient as possible under the adverse conditions under which it must work.

If you are of an experimental turn of mind and don't care particularly what appearance is presented by the outside of your car you might try rigging up a multiwire antenna on the roof of your car. Pioneers in this field even went so far as to erect a fore-and-aft mast upon which were fastened spreaders to support the antenna wires. Trucks which have been fitted out for radio reception have found this method of antenna construction particularly helpful.

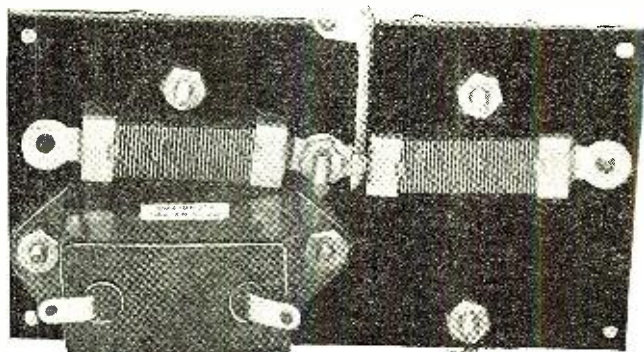

The by-pass condenser and the three new filament resistors are fastened under screws as shown

Some experiments have uncovered the fact that strips of wire screening, mounted under each of the running boards, provided quite an excellent pickup when used for an antenna.

Too much serious thought cannot be given to this very important problem. We meet up with an entirely new set of considerations. As has been pointed out we are not dealing with the same conditions as at home. Virtually we are erecting an antenna inside of a shielded compartment—and expecting

it to provide pickup on a par with that experienced at home. Some job.

One other important item is the installation of an auto-radio receiver is the production of man-made static, so to speak, which is generated by the induction coil, spark plugs and associated ignition wiring. Just look at the picture for a moment. Here we have a receiver in an automobile, the antenna probably is inside the car, or if not, quite close to its metallic body, and finally we have in the immediate vicinity of the very limited pickup agency a strong source of interference. Unless the interference is practically eliminated, then attempts to increase the pickup powers of the antenna will go for naught because it will, at the same time, introduce more interference from the motor than a less efficient antenna.

Fig. 3. Details for drilling the shelf, and for cutting and tapping the studs which support the shelf are shown here. Note that the front studs (those near the front panel) are longer than those at the rear

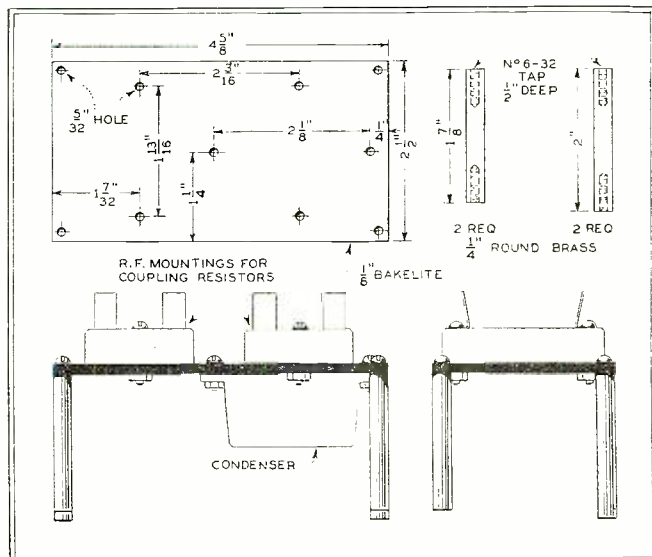



# Where Are those Radio OPPORTUNITIES?

*An answer to the skeptics who hold that radio is overcrowded and that radio men are underpaid*

By Austin C. Lescarboura

**T**O state publicly that a world of opportunity awaits the radio-trained man is to bring avalanche of protests down upon one's head. These letters come from many sources, ranging from self-made radio handmen to correspondence school students and graduate radio engineers. Taking the protests at their face value, one is compelled to grant that radio is just about the last hope. But rather than have thousands of skeptics remain unanswered while we continue to report on the opportunities found in radio and allied fields, we accept the challenge and go to the mat forthwith.

Opportunity—just what is opportunity? Arguments are only too often based upon different interpretations of terms. Opportunity, as employed in our survey of radio, means briefly that a given kind of work meets a given type of man. If the work cannot find the man, or vice-versa, there is no opportunity. Therefore, the mere possession of a radio diploma, as many of our correspondents have pointed out, does not necessarily mean an immediate and astounding success in life. We hasten to agree. There is nothing new or unique in such a situation. It occurs in many other fields also. Thus the sheepskin for medicine, law or engineering does not serve as an appointment to outstanding positions in the respective field, the opinion of most college graduates to the contrary, notwithstanding. The proud possessor of a sheepskin from any of our colleges is simply receiving an invitation to roll up his sleeves and really go to work in his chosen field. The outstanding position must be sought and won by dint of perseverance and hard work. There is no royal road to success.

Why should radio be different? A radio course is a matter of six months, and represents an investment of from one hundred to one hundred and fifty dollars, as contrasted with four years or more, and an investment of thousands of dollars, for a course in another technology. Surely if the mere possession



*Mr. J. E. Smith, President,  
National Radio Institute,  
Washington, D. C.*

*Dear Mr. Smith:*

*Since finishing your course some three years ago I have been on four ships and have taken in all of the principal sea ports of the world.*

*I took my Government examination in New Orleans and made a grade of 86 per cent. out of a possible 90 per cent., on September 2, 1926. I got my first ship on September 3rd—the next day—after receiving my license. Here is one of the biggest advantages of studying radio with you—while taking your course I made more than enough to pay for it in my spare time working on receiving sets in the neighborhood. At the same time I made a name for myself as an expert radio-trician, which was due solely to your clear and easy, understandable training.*

*I must thank Mr. Murray, your employment manager, for his untiring, efficient and most appreciated help in securing a good job for me at WTIC.*

*What I consider the salient points of your course are: your policy of giving instruction to graduates on new apparatus; revising your course every time a new and practical piece of apparatus comes into use, and the prompt, courteous and careful attention you pay all students and graduates. This service makes the N. R. I. course outstanding and far superior to any other that I have as yet seen.*

*With grateful thanks and regards, I am  
Sincerely yours,  
WALLACE E. RUSHING.*

of a radio diploma immediately entitled one to a big paying position, we should have nothing but radio men in this world. Too many graduates of radio correspondence schools and radio resident schools expect to secure positions of outstanding importance the moment they complete their studies. Without practical experience, they contemplate leaping over the heads of practical radio workers and taking key positions. And yet these same men, if confronted with similar expectations expressed by budding doctors, lawyers or engineers, would be the first to ridicule such foolish notions.

No, radio is no different from any other line, as far as easy and immediate success is concerned. Due to the rapid development and unforeseen expansion of radio technique, there are many and exceptional opportunities in the radio field, but these opportunities call for men with proper knowledge, training and executive ability.

Let us examine the question of proper knowledge. Many of the protests received are, frankly, written in the poorest English. This may be taken to indicate a modest education. Few of the writers of such protests seem to realize that radio, bringing workers in close contact with the public, expects keen, well-educated men, particularly for key positions. Everything else being equal, the well-educated man is certain to receive preference. Citing an instance of the need for general education quite as well as radio training, the writer recently attended a gathering of radio correspondence-school graduates in Washington, D. C. The occasion was the Fifteenth Anniversary of the National Radio Institute. At its own expense, that organization had brought its outstanding graduates from all parts of the country, and even from Canada and Bermuda. Spending two days with these men, the writer was in a position to determine just what makes for success in the radio field.

First of all, it was immediately apparent that these successful radio men were intelligent, fairly well educated,



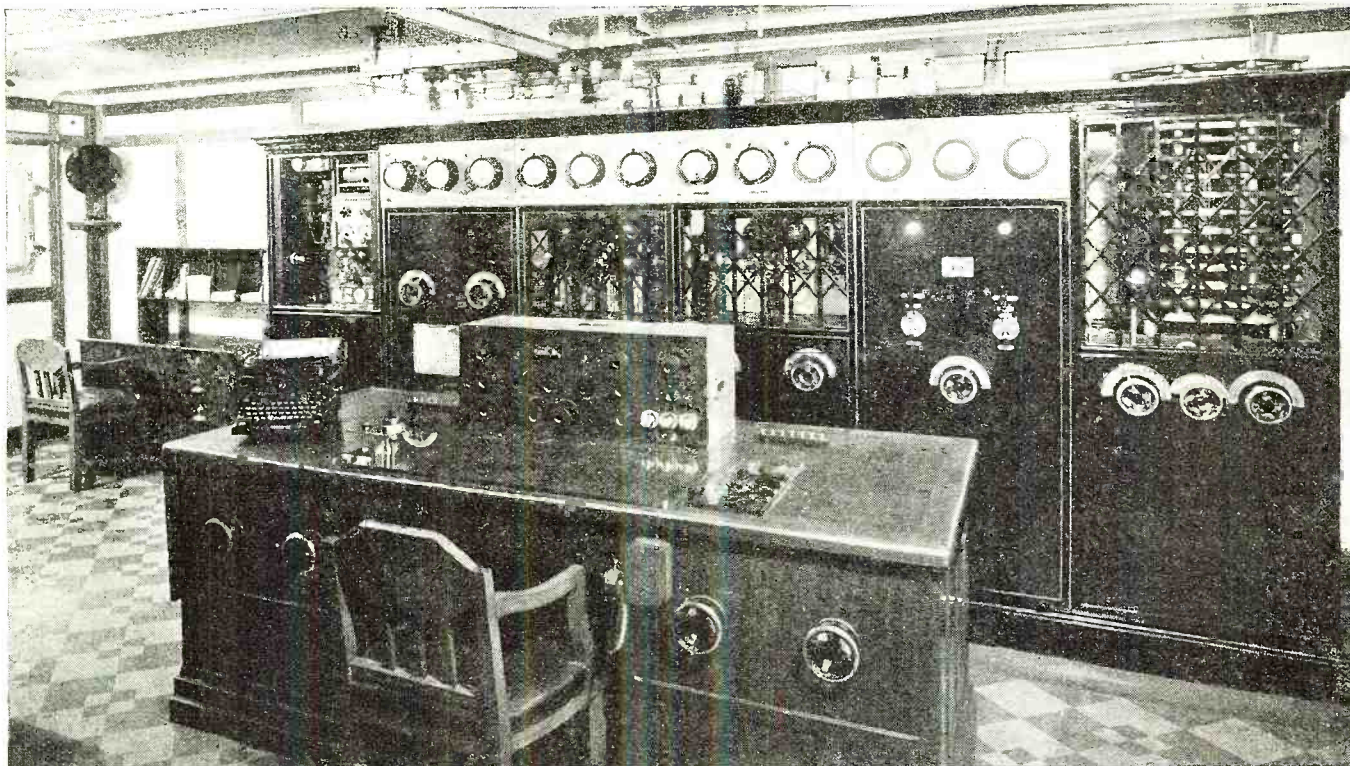

Radio room on the *Ile de France*, where the operators who man this newest of equipment spend their working hours between visits to Paris and New York City

and ambitious. Many of them spoke at the banquet, and in other ways indicated that they were born leaders of men. Also, these men were unanimous in regarding the radio correspondence course simply as the tool with which to go to work, and not as the final opportunity itself. Furthermore, these men displayed the keenest interest in radio progress, and wanted to know what was expected by way of developments in the future. They were, in brief, not living on their past glory and training, but rather growing up with radio progress. Some were college men; others were from various highly organized fields; many were born merchants who would be selling stoves or groceries or grain if they had not been attracted by the romance of radio. But in each case it was evident that these men had the basic foundation for success, and that they had taken the radio route instead of a more prosaic one.

Aside from a fundamental education which is as essential in radio as in any other profession, there is the question of radio training. Many who protest are really untrained. They are of the self-taught handy-man variety. They think they know radio. While such men can no doubt take care of servicing on the old-style battery type receivers, with all components exposed, or again make simple adjustments and repairs on present-day all-electric sets, they are quite incompetent when it comes to servicing receivers in which all components are sealed, and must therefore be diagnosed by continuity tests and measurements. Many so-called radio men have built "hay-wire" receivers and transmitters, and immediately feel competent to assume charge of a broadcasting station. Or again, in the matter of radio operating, many men who can handle code at 25 words per minute, wonder why they cannot make the grade of chief operator on board the palatial ocean liners. It never occurs to them that the chief operator should do thirty-five words per minute and be above the ordinary.

One great trouble with radio men, we are told by Rudolph L. Duncan, President of RCA Institutes, and the mentor of thousands of radio students and graduates, is that they stop studying too soon. Radio, explains this authority, is in a constant state of flux. It is developing all the while. The man who stops studying when he receives his radio diploma is apt to find himself in the boots of Rip Van Winkle when he goes looking for a job a few years later. The radio operator aboard ship has an unrivaled opportunity for study. He works no more than two or three hours out (Continued on page 953)

Mr. R. L. Duncan,  
R. C. A. Institutes, Inc.,  
New York City.

Dear friend Mr. Duncan:

When I left New York the first of June I carried with me the thought that were it not for your kindnesses and the instruction received from the school I probably would still be standing behind a lathe in some dirty machine shop. Although it was my trade, I always was dissatisfied, and therefore I sincerely say that the R. C. A. Institute was the means of me getting into a new field of endeavor and one in which I am very much satisfied.

From the very day that I went to work for R. C. A. as a ship operator I have moved steadily ahead, both in knowledge and in salary. I believe I told you when I saw you last that I was coming to this station WEBC as chief operator, and so I did. I think it's about as good a job as one might expect at this stage of the game.

Before closing I might state that you have my permission to use my name as reference to the splendid instruction which may be obtained from your school, also for the fair and courteous attention given those who attend from near and far. I can never speak too highly of you and your school.

Sincerely,

EUGENE J. KRUSEL.

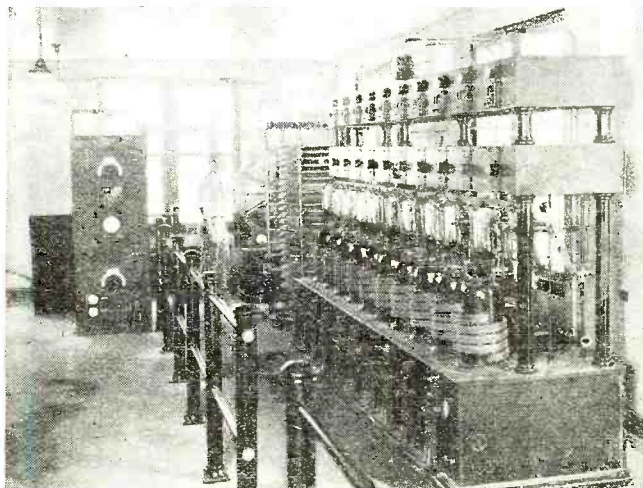

The transmitting room at WEAF. More than fifty of the National Broadcasting Company's technical operating staff are radio school graduates



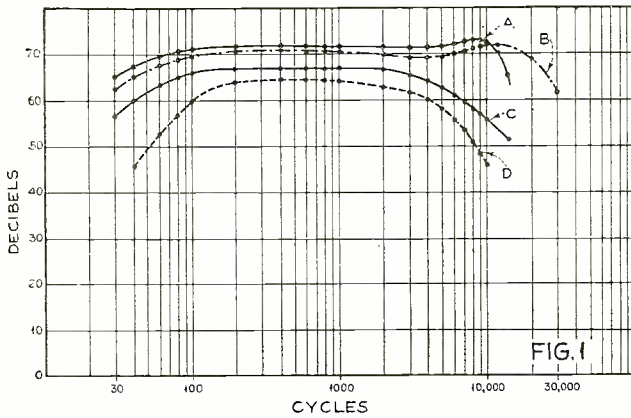

Curve A shows the frequency response of the final model of the amplifier. Curve B was an experimental model built to determine the maximum high-frequency response. One type of straight-resistance-coupled amplifier with output transformer is shown at C. Curve D is typical of transformer-coupled designs which are common

# An AUDI Power-

*High quality reproduction with  
terize this public-address unit*

By Hugh S.

**A**LTHOUGH the use of screen-grid tubes in radio-frequency amplifiers has become quite common, their application to general-purpose audio-frequency amplifiers has been retarded by a number of shortcomings. Principal among these is the fact that very high coupling impedances must be used to take advantage of the gain that may be secured and the circuit and tube input capacity which necessarily load the interstage unit, seriously affect the high-frequency transmission. With the advent of a number of speakers which have been announced, or will be in the immediate future, which are very satisfactory up to 8,000 or more cycles, a decided impetus has been given to the design of amplifiers with a flat frequency characteristic up to 10,000 or more cycles.

Then, too, a resistance-coupling device is almost a necessity when operating out of the -24 type tube into a high impedance, due to the difficulty of securing a high and uniform impedance with the inductive type of couplers. The use of a high resistance necessitates the use of a high-voltage power supply with a resultant increase in cost.

The S-M 692 amplifier was built with the requirements of uniform transmission over the entire useful audio range, interpreting this broader frequency range in terms of the requirements of the new speakers and the insistent demand for amplifiers which are capable of reproducing speech faithfully. Although a number of amplifiers have very satisfactory bass reproduction, at the upper end they begin to cut off at about 6,000 cycles, or even sooner, and at these frequencies (at normal intensity) the ear can detect a minimum difference of approximately 1/2 d.b. An inspection of the curves of two of the dynamic speakers which are credited with reproducing the voice most clearly has shown that although they suppress the bass slightly, the important difference is in the high-frequency response. One such speaker goes down to 30 cycles very satisfactorily and yet sounds much "crisper" than the usual type of speaker and more distinct, due to the upper register which has been extended up to more than 8,000 cycles without any pronounced peaks. The faithful reproduction of speech requires a uniform amplification of all of the harmonics or overtones

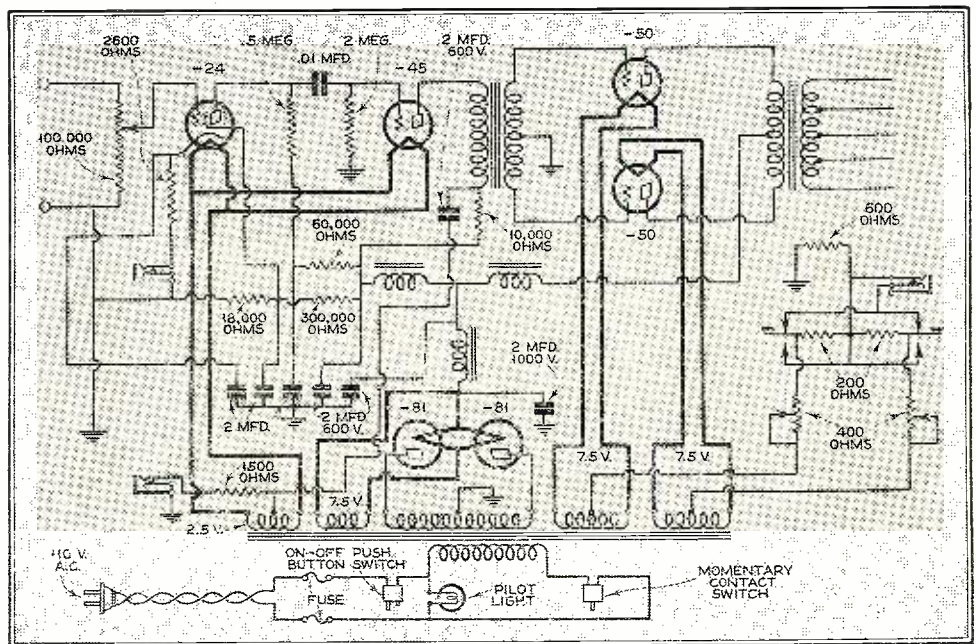

A schematic wiring diagram of the completed amplifier. The special circuit to permit either -50 tube plate current or some of their currents to be measured is shown at the right-hand side. The 2 mfd. 1,000 volt condenser, which is the first one in the filter system, is housed in a separate can so that it can be replaced, if necessary, without disturbing the large condenser bank. The momentary contact switch is closed when the cover and false bottom are in place

as well as the fundamental. That is, when the note middle C on the piano is to be amplified not only the fundamental note or frequency of 256 cycles must be amplified, but the overtones of 512, 1,024, 2,048 cycles, etc. The relative intensity of the fundamental and the overtones must be retained, since it is the relative values of these which distinguish a piano note, say, from a flute note of the same pitch. If the higher overtones or harmonics of a piano note are suppressed the note retaining these overtones (many of which lie in the range of from 6,000 to 10,000 cycles) that makes the reproduction of piano music in the "talkies" so poor.

The ear, which is a delicate though imperfect mechanism, enters into the final problem of translating variations in air pressure or sound waves into the sensation of hearing. Its sensitivity varies greatly with frequency or pitch and with intensity or loudness. The ear's response to different sound intensities is not uniform. If one sound appears to be twice as loud as another of the same pitch it has approximately four times as much power. In other words, the intensity or loudness is not directly proportional to the sound energy, but to the logarithm of the power. If the logarithm of the sound energy is taken it therefore provides a much better measure of the ear's response, which is the final thing in which we are interested.

\* Engineering Department, Silver-Marshall, Inc.



# TORIUM Amplifier

ample reserve power character that may be assembled from a kit  
Knowles\*

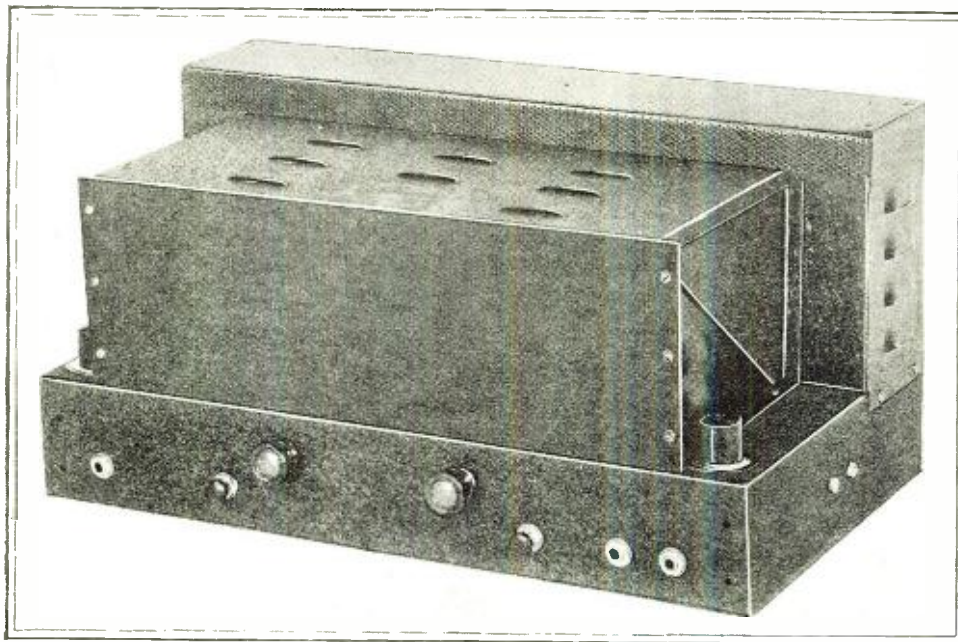

Jacks to permit the measurement of individual tube currents, the push-button switches and the -50 tube bias control may be seen in this view. The tubes are placed in the rear perforated compartment which fully protects them. The input plugs which permit ready connection of input and output circuits are shown at the right and left front corners

For example, if one sound has two units of energy and another eight, the energy ratio is four; that is, the latter has four times as much energy as the former. The logarithm of eight, however, is only twice that of two, so that the logarithms of the two numbers gives a better measure of the ear's response to the two.

For this reason the unit "decibel," abbreviated d.b., has been used in giving the amplification curves of the amplifiers described. (Quantitatively, the decibel is defined as twenty times the common logarithm of the ratio of the output to the input voltage, or ten times the common logarithm of the ratio of the output to the input power. The actual values which are commonly required are as follows:

Voltage ratio	Percentage difference	D.B.
1.3 to 1	30%	2
1.6 to 1	60%	4
2 to 1	100%	6

In changing losses in decibels into percentage, the percentage the smaller value is of the larger must be taken so the voltage ratio of 1/2 to 1 would represent a difference of 50%, or 6 decibels (corresponding to an increase of 2 to 1).

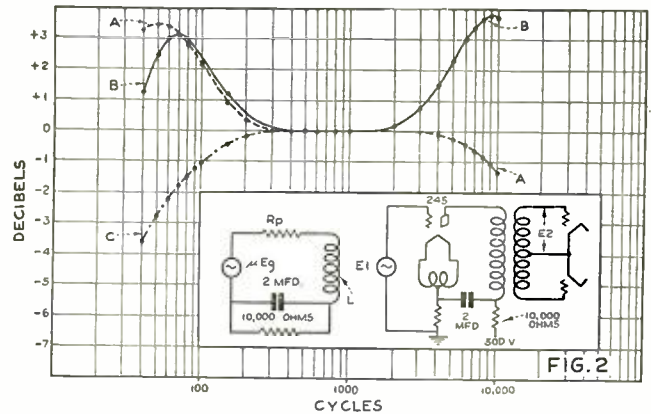

These curves illustrate the contribution of primary resonance in a transformer to bass or low-frequency response and the effect of the leakage reactance and distributed capacity on the high-frequency response. A preliminary design with very good bass is shown at A. Curve B shows the final design which was developed to improve the high-frequency end and the curve starting at C and ending at D is for the transformer without any primary resonance effect

The sensitivity of the ear varies with frequency as well as with intensity. At very low frequencies of from 30 to 40 cycles the ear cannot detect a difference of less than 3 d.b. (about 44% increase). so there is no point in keeping the response uniform or "flat" within any closer limits. At frequencies of 6,000 to 10,000 cycles at normal intensity, the ear is much more sensitive and can detect differences of 1/2 d.b. or less than 10% difference in voltage amplification.

The curve of the completed amplifier is shown in curve A, Fig. 1. This shows that the curve is flat within the limits of precision of the measuring instruments to from 100 to 5,000 cycles. At the very low frequency end of this curve the minimum perceptible difference, according to Fletcher, is about 3 1/2 d.b.

At the extreme upper end of the curve, which has been extended in the graph up to 14,000 cycles, the minimum perceptible difference is nearly as high as at the low end, due to the decreasing ear sensitivity near 16,000 cycles. As far as the ear is concerned, therefore, the curve is substantially flat over the entire audio range.

For the sake of comparison, the curves have been plotted in d.b. rather than in voltage gain for the reasons given above. This makes the difference in the overall voltage amplification less apparent, but it simplifies the comparison of individual coupling units which will be considered later. Curve A, for example, has a gain of 72 d.b. which correspond to the voltage amplification of 4,000. Curve D, on the other hand, which is typical of three-stage audio-frequency amplifiers which are now common, has a maximum gain of about 63 d.b., corresponding to a voltage amplification of less than 1,600. Over the more or less flat portions of the curve, A has 150% more amplification than B, and the difference at the high-frequency end is even more striking. At 10,000 cycles, curve B has fallen to a voltage amplification of 100 or to about 10% of the value at 1,000 cycles. Curve A, on the other hand, is about 10% higher at this frequency and has an amplification at 11,000 cycles equal to that at 1,000.

(Continued on page 963)



# Socket-Power for the "Boy Scout" Four

*A power supply for the "Boy Scout Broadcast Receiver"  
from which filament current may also be obtained*

By John B. Brennan, Jr.\*

**A**LTHOUGH designed especially for use with the "Boy Scout Four" receiver described in last month's RADIO NEWS, the B-C power supply unit may be used successfully with any receiver requiring plate voltages not greater than 180 volts and grid biases not greater than 40 volts.

It will be remembered that the receiver described in the last issue of RADIO NEWS employed four tubes, namely, a tuned neutralized stage of radio-frequency amplification, a regenerative detector and two stages of transformer-coupled audio-frequency amplification. In all of the stages but the last type -01A tubes were used, the final stage employing a -12A tube. The voltage requirements for this set were 90 volts for the r.f. stage, 45 volts for the detector stage, 90 volts for the first a.f. and 135 volts for the power amplifier stage. Grid biases of  $4\frac{1}{2}$  and 9 volts were required for the first and second audio stages, respectively.

The building of a suitable power supply unit capable of meeting these requirements does not entail a great deal of originality in design, since the circuit found most suitable through satisfactory use over a period of years has not been altered materially.

New and radical changes in some of the parts which may be employed, however, assure us that the supply unit we build nowadays will give unsurpassed performance over a greater period of time than was possible with the older, less perfected type of apparatus.

For instance, it is possible now to build a power unit incorporating in its construction such items as the electrolytic condenser and the rapid heat dissipating, accurate, and easily controlled voltage divider resistance banks. In an astonishingly small space, by means of the electrolytic condenser, it is possible to obtain a total capacity of some 24 or 32 microfarads, whereas in the older types of power supply units the space required for the same capacity would have been fifteen or twenty times greater, and at a correspondingly greater cost.

With voltage divider resistance banks it is now possible to obtain units which are easily regulated and which, once set, maintain their resistance value within limits, are quiet in operation and are built to dissipate a maximum of heat without injuring the element itself. Compare this to the days when burn-outs were frequent, resistance values wandered all over

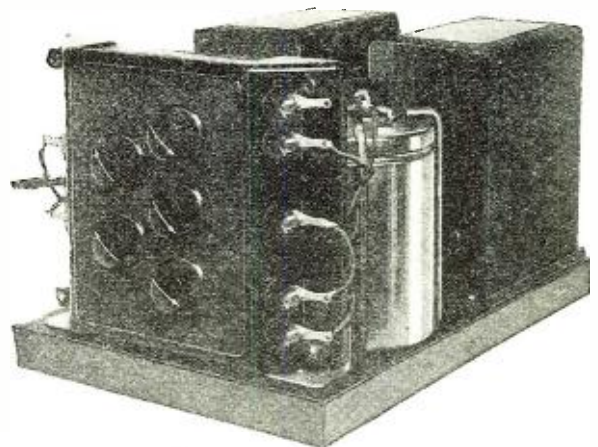

By means of the conveniently located voltage divider three accurately adjusted plate voltages and two grid bias voltages may be obtained

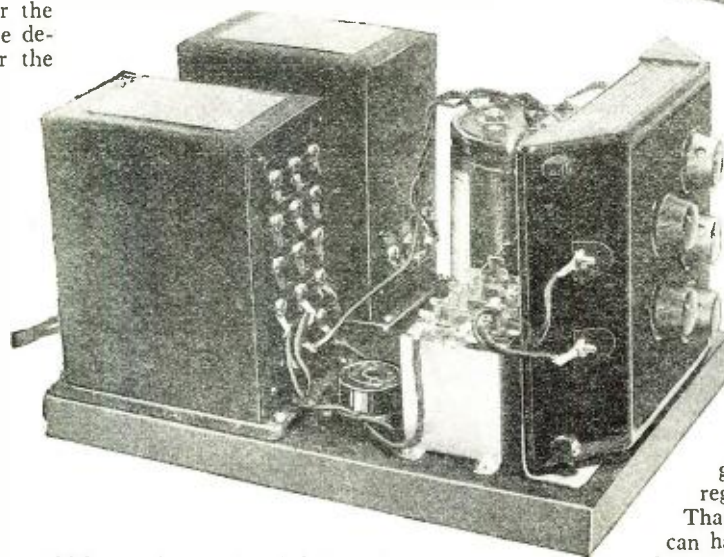

The parts have been mounted on the baseboard with ease of wiring and compactness uppermost in mind

the map and regulation was something greatly sought for but never permanently obtained. Yet some surprisingly good power units were designed regardless of these many handicaps. That conditions are now in our favor can hardly be denied. Which brings us then to a consideration of the immediate

problem at hand—that of designing a satisfactory B-C power supply unit for last month's receiver.

Essentially all power supply units furnishing a d.c. output from an a.c. input comprise a step-up transformer to supply voltage values which are in excess, slightly, of those actually required by the plates of the tubes to be supplied, a rectifier unit to change the stepped-up alternating current to a pulsating d.c., a filter unit to smooth out the ripples in the pulsating d.c. so as to provide a pure direct current to the plates of the tubes, and finally an output voltage divider system which provides voltage values ranging from the full or total output from the filter section to zero volts (B—).

Choice of line or power transformers depends largely upon the voltage which is required for the plate of the power tube in the receiver. For instance, one type of transformer will be satisfactory for a device which is to supply a receiver employing in its final audio stage a -71A tube, whereas it will not be at all satisfactory for a power unit which is intended to supply

\*Scoutmaster, Troop 3, Hollis, N. Y.



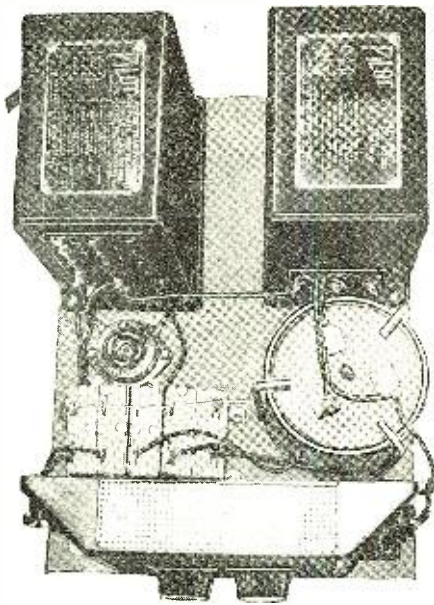
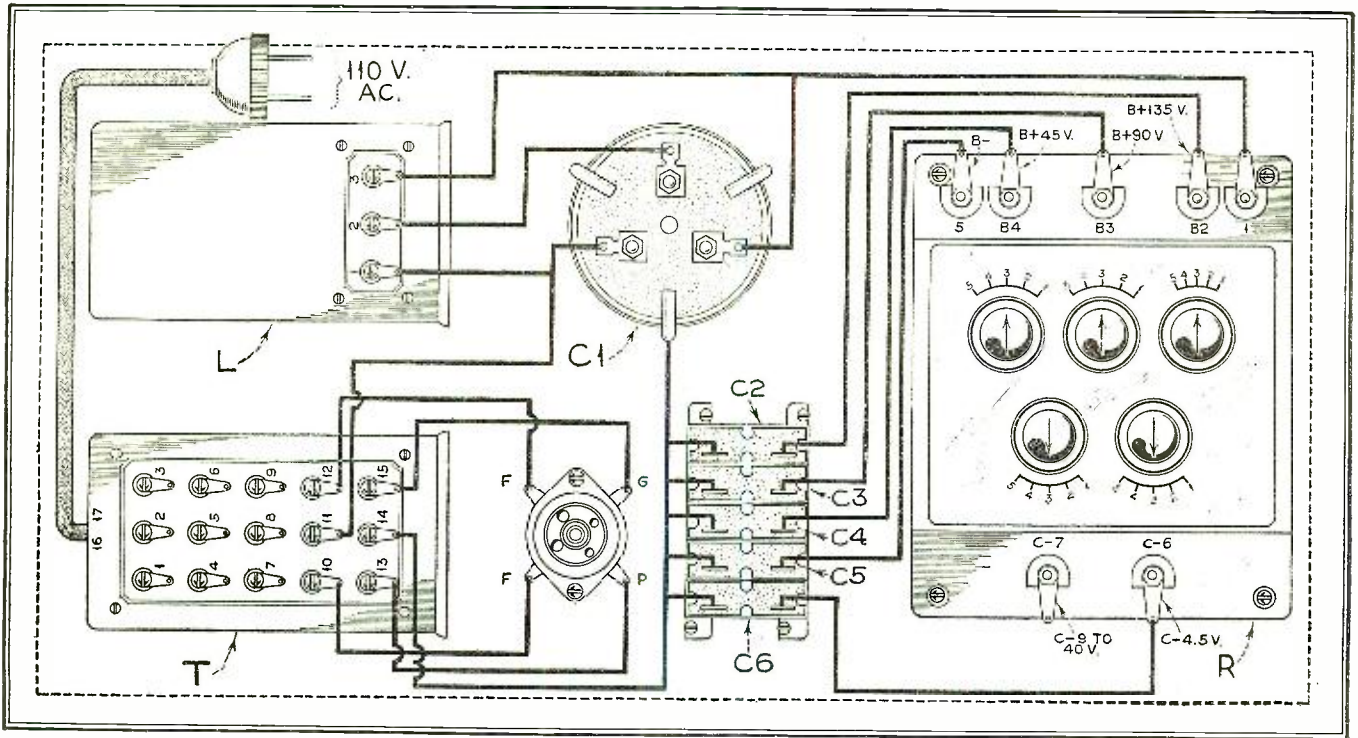

You can't go wrong if you wire your power supply from the picture wiring diagram shown above. Each part is shown in approximately the same place that it occupies in the finished job

Compare this illustration with the diagram above, if you are at all in doubt about the identification of the various parts

- One socket (for rectifier tube)
- One Mershon filter condenser, three-section, each 8 mfd. (C1)
- One Electrad truvolt voltage divider (R)
- Five Flechtheim filter condensers, 1 mfd. (C2, C3, C4, C5, C6)
- One baseboard, 7½ inches by 10 inches by ¾ inch
- One box Corwico stranded braidite
- One Triad, Eveready, CeCo or Marvin -80 rectifier tube.

When these parts have been obtained they should be inspected for loose nuts, bolts and the like, since it is much easier to tighten them when the parts are first obtained than when the construction has been completed.

Fig. 1 shows the manner in which the parts are laid out on the baseboard. Along the rear edge is placed the transformer and the filter choke. Directly forward of these two pieces of apparatus are placed the socket for the rectifier tube at the left, and the filter condenser at the right. In front of the rectifier tube socket is placed the batch of output filter condensers, while along the front edge of the baseboard is located the output voltage divider.

Wiring is simplicity itself. Two types of wiring diagrams are shown for the builder's guidance. That in Fig. 2 is what is called a schematic circuit where the parts are represented symbolically. Fig. 3 shows a picture wiring diagram where each part is represented in picture form, the connections being shown as actually made in the construction.

plate voltage to a receiver employing a -45 or -50 tube (which would require very high voltages). Choice of a rectifier tube is governed by the size or voltage output of the transformer which is finally chosen. In installations which supply power tubes up to and including the -45, a type -80 or full-wave rectifier tube is satisfactory; but for power units intended to supply tubes of the -50 type, either a single-wave rectifier of the -81 type or two of them connected for full-wave rectification must be employed, since they alone are capable of handling the higher voltages.

And so we might continue showing how it is necessary to pick the parts for the job that they must do. Suffice it to say that for the particular power unit under discussion here, parts have been chosen from both a performance and an economic standpoint.

- They are:
- One Pilot line transformer, No. 398 (T)
- One Pilot filter choke, No. 395 (L)

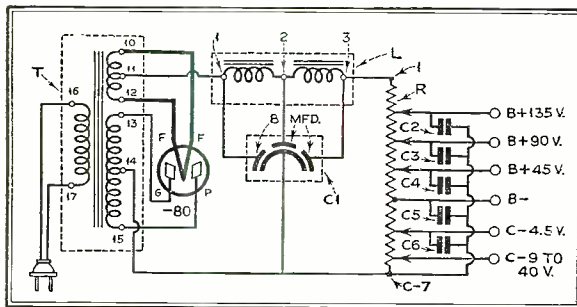

This is the schematic circuit of the B and C power supply. It jibes completely with the picture diagram above. The dotted lines indicate those units which are self contained, such as T, the transformer; L, the filter choke, etc.

On the power transformer only one filament winding is used, that for the filament of the -80 tube. Other filament windings are provided and if the constructor so desires he may rewire his receiver to take the -27 type of a.c. tube, employing the 2.5-volt winding and the 5-volt winding for the -12A tube in the power stage.

To put the power unit in operation it is necessary only to connect the terminal wires from the receiver to their respective terminals on the voltage divider of the power supply device, plug in the cord of the line (Continued on page 956)





# The Junior RADIO Guild



## LESSON NUMBER NINE

*Here are the constructional details for adding a three-stage resistance-coupled audio-frequency amplifier to the tuner unit described last month*

**I**N the design of a radio receiver we strive for three things. First we want good selectivity. That is, we want the receiver to be able to tune in one desired station at a time, to the exclusion of all others. Secondly, the receiver must be sensitive. That is, it must be able to reach out, so to speak, and pick up signals from stations which are far removed from the location of the receiving station. In other words, what we want is distance-getting ability. Then, the third thing that we want in a receiver is good tone quality reproduction.

The sensitivity of any receiver is determined largely by the design of the tuner unit, and a satisfactory tuner for the Junior Radio Guild Receiver was described last month. The unit described this month takes care of the audio amplifying job of the receiver. It is this section of the receiver which amplifies the feeble impulses from the detector, sent along to it by the r.f. amplifier. It is this part of the receiver that builds up the signals so that we can hear them (without the aid of earphones) at full room volume with a loud speaker.

Generally speaking, there are three main types of audio-frequency amplifiers. These are the transformer-coupled audio-frequency amplifier, the impedance-coupled audio-frequency amplifier, and the resistance-coupled audio-frequency amplifier. It is the latter one which we have selected for the Junior Radio Guild receiver to the work of amplifying the received signals. In addition to the feature of resistance coupling, which makes for very fine tone quality in any receiver, we are using in this receiver, the now well-known screen-grid tube. Two such tubes are used in the first and second stages of resistance-coupled audio-frequency amplification, while in the third stage, the power stage, a -12 tube is used. The advantage which lies in the use of the screen-grid tube in a resistance-coupled audio-frequency amplifier is that it produces tremendous amplification per

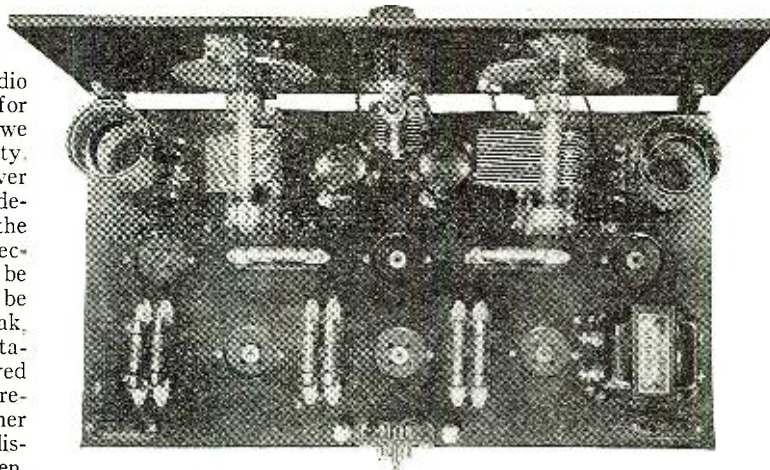

stage; more than we could obtain if we were to use the common -01A type of tubes. These latter tubes have an amplification factor of approximately 8, whereas the screen-grid tube has a theoretical amplification of 250 and a practical amplification, depending upon the circuit in which it is used, of 20 to 30. So, you see, there is a real advantage to be obtained in the use of screen-grid tubes in a resistance-coupled audio-frequency amplifier, providing the correct type of circuit is employed.

The circuit described here is flexible enough so that if it is desired, the builder may substitute a larger type of power amplifier tube for the -12A. In other words, if he wishes to employ the -71A he may do so with only slight changes in the circuit. Of course, with the use of this new power amplifier tube not so much volume will be obtained as with the -12A type, but, on the other hand, it will handle more powerful signals which are passed along to it by the previous stages of audio-frequency amplification. This can be readily seen when we point out that the amplification factor of the -12A tube is 8, while the amplification factor of the -71A is only 3. On the other hand, the -12A type of tube can handle a signal which is on the order of about 9 volts, whereas the -71A tube can handle a signal which is on the order of approximately 40 volts. If the change-over is made from a -12A to a -71A in the power stage, it will be necessary to apply different voltages to the grid and plate circuits of the power tube than are

**L**AST month we described the construction of the tuner section of a six-tube receiver. This month the audio channel is added. There are two things to note about this audio amplifier: it employs three stages of resistance coupling, making for very excellent tone quality, and, secondly, screen-grid tubes are used. The Junior Radio Guild department teaches you about radio by showing you how to build receivers. Eight lessons have already appeared, each giving elementary theory, others describing construction methods. Keep abreast of the times and add to your practical knowledge of the art by following these constructional articles.

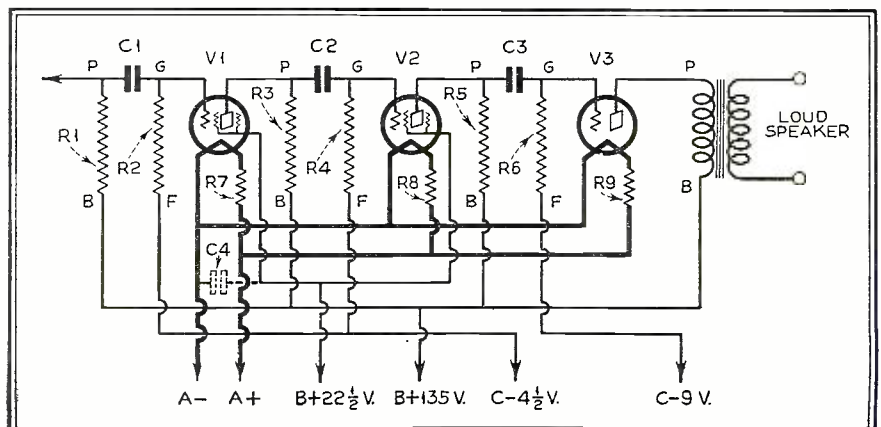
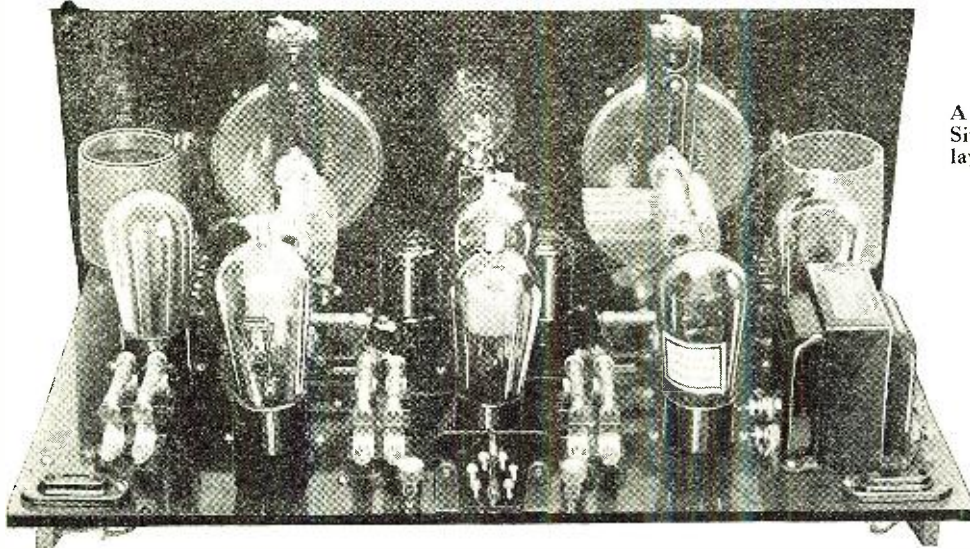

Fig. 1—Three stages of resistance-coupled audio-frequency amplification comprise the Junior Radio Guild audio channel. Two screen-grid tubes of the -22 type and a power tube of the -12A type are employed





A behind-the-panel view of the JRG Six which illustrates the symmetrical layout and neat design which characterize the receiver

By-pass and coupling condensers are mounted underneath the sub-base together with the filament resistors. Practically all of the wiring is done underneath, making for a very neat appearing top panel appearance

indicated on the circuit diagram, Fig. 1. The values of voltage indicated on this figure are for the -12A type of power tube and if the change is made to the -71A, 40½ volts will necessarily be required on the grid of the tube in place of the 9 volts, as shown, and 180 volts will be required on the plate instead of the 135 volts, as shown. This will mean that to accomplish this it will be necessary to bring out extra leads to the batteries, since not enough leads are provided in the connector cable.

In Fig. 2 is shown the picture wiring diagram of the three-stage resistance-coupled amplifier. Note how similar in construction it is to the schematic circuit shown in Fig. 1. In the latter, symbols are used to represent the various parts which are employed in the circuit, while in the picture wiring diagram an actual picture is drawn of each of the parts employed. Coupling between the first audio amplifier tube and the tickler circuit of the detector tube which was provided for in the tuner unit described last month is accomplished through the use of a resistance-coupling device. Similar resistance-coupling units couple the first, second and third audio stages. In the output circuit a loud-speaker coupling transformer is employed to connect the speaker to the plate circuit of the power tube. The advantage of its use lies in the fact that it removes the battery from the speaker windings, which otherwise would paralyze it to cause distortion. The filament circuits of each of the three tubes is provided with a separate filament resistor—in the case of the first two tubes, a resistance sufficient to drop the applied six volts to 3.3 volts necessary for the operation of the screen-grid tubes. For the power amplifier tube, the 4-ohm resistor drops the 6 volts to the required 5 volts.

In some cases, after the amplifier is set up for operation, it may be found that coupling through the wiring of the receiver

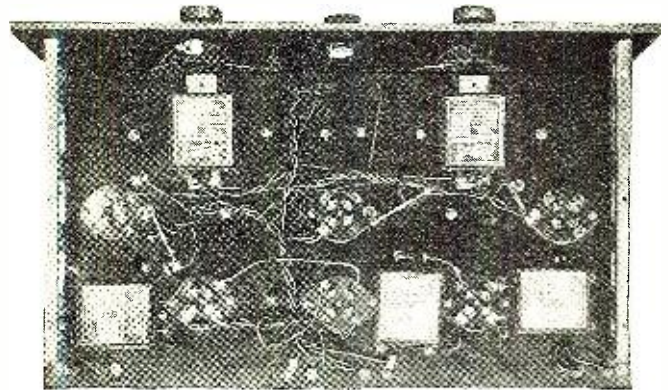

is produced to cause an audio oscillation. In this case it will be necessary to by-pass the r.f. currents in the screen-grid circuits by the inclusion of the by-pass condenser, C4, whose position in the circuit is shown in Figs. 1 and 2.

Details for mounting the various parts which comprise the resistance-coupled audio-frequency amplifier are shown in the accompanying photographs and circuits. Along the rear of the sub-panel, in the place previously provided for the audio amplifier, are arranged the three resistance-coupling units, the three-tube sockets and the output transformer. Underneath the sub-panel are located the coupling condensers for the resistance-coupling unit, the filament resistors and the by-pass filter condenser, if it is found necessary to include this latter unit in the circuit. Full wiring details for hooking up the receiver are shown in the picture wiring diagram in Fig. 2. The schematic circuit is shown in Fig. 1.

Once the set is wired and ready for operation, it will be found likely that it will be necessary to experiment with the plate voltages so as to make the receiver operate satisfactorily. For instance, depending upon the tubes used, and since no two tubes are

Fig. 2—The JRG Six audio amplifier circuit in picture form. Note how similar in layout it is with the schematic circuit shown in Fig. 1. By studying the two you will easily learn how to use symbols and read circuit diagrams

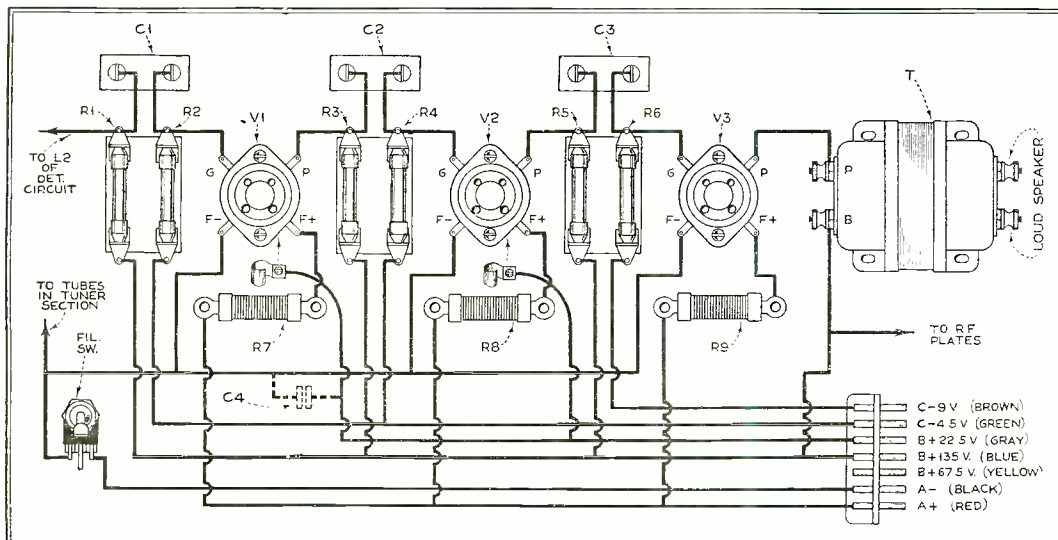



## ~RADIO NEWS HOME LABORATORY EXPERIMENTS~

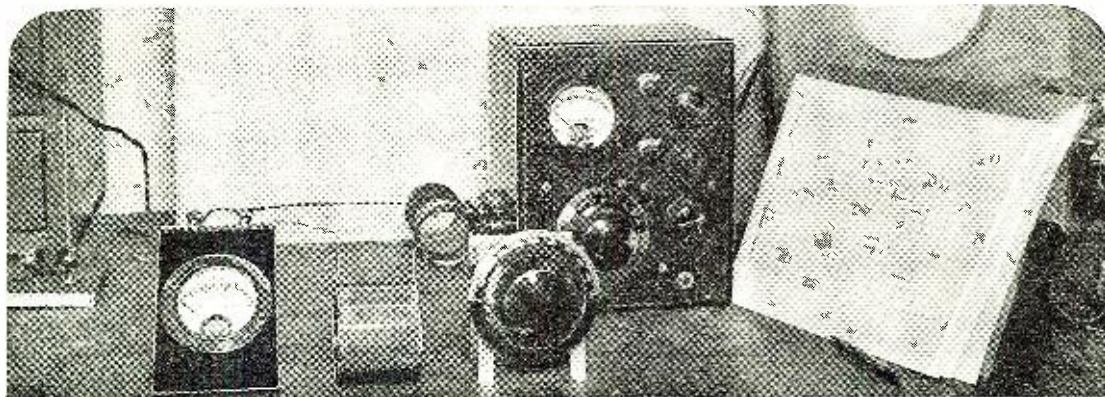

Laboratory apparatus used to obtain the data presented here

# Tuned Circuits and How They Function

**W**HAT happens when we tune a receiver? We turn the dial, one station fades out, another comes in. Why? By this simple question we are brought immediately into direct contact with some of the most fundamental problems in radio. This apparently elementary question is one of the most difficult to explain.

When a radio receiver is tuned the operator demonstrates—although he probably doesn't realize it—one of the most fundamental things in radio—the characteristics of "tuned circuits." We have all seen diagrams of "tuned circuits" such as that indicated in Fig. 1. Here L is the coil, which consists of some 50 to 100 turns of wire wound on a tube, and C is the variable condenser, which consists of a number of metal plates, some stationary and others movable, the two groups of plates being insulated from each other. One of the ends of the wire from the coil is connected to the stationary plates, and the other end is connected to the stationary plates. See Fig. 2.

Now we all know (if we don't we can find out by opening up the cabinet of a receiver and watching what happens as we turn the dial) that when we turn the dial of an ordinary receiver we cause the movable condenser plates to turn and mesh more or less with the stationary plates. Evidently this operation of tuning a set has something to do with the position of these plates. We can also determine the fact, by referring to the list of call letters on page 332 of the October issue of RADIO NEWS, that the movable condenser plates are most completely meshed with the stationary plates when we are tuned to some station broadcasting on the longer wavelengths around 500 meters. When we are listening to low wavelength stations around 200 meters we will note that the condenser plates are almost completely out of mesh with each other.

Let us take a coil and a condenser and connect them in series with a meter which will indicate whether there is any current flowing in the circuit. Now suppose we lived but a short distance from some broadcasting station, WEAf for example, whose transmitter

is located on Long Island, N. Y. Now we set up the coil, the condenser and the meter, and as we slowly turn the condenser dial we watch the meter. If we start at the position where the movable plates are all out of mesh we will find that it will be necessary to rotate the dial until the movable plates are about two-thirds in mesh before anything happens. Then we will note that the meter will rather suddenly begin to indicate some current, and that the current will very rapidly increase as the dial is slowly turned. Then the needle of the meter will, for a moment, reach a high point and stop increasing. As we continue to turn the dial the needle will rapidly begin to return to zero. If we were to plot the movements of the meter needle on a piece of cross-section paper, we would get a curve like that of Fig. 3. This is known as a "resonance curve," and the point at which the needle indicated a maximum current is the point of exact resonance. Now when we tune a single control set having several tuned stages, the dial causes several condensers to turn, so that we get the combined effects of several of these "tuned circuits."

In tuning a set we cannot ordinarily measure the current as we did in the preceding experiment, for the currents are too small. But in place of the current we can listen to the loud speaker volume and note that it rises, reaches a maximum and then decreases exactly as did the current. And whenever we tune to a station we will note the same things—a rapid rise, a definite peak and then a rapid fall. Now we have, perhaps, some idea of what happens when we tune the set, and we can picture in our mind the rising and falling currents in the various tuned circuits. But why do these circuits behave in this manner?

Here we have to get at the meaning of some new terms. We are all familiar with the word "impede." Rust in a water pipe impedes the flow of water through it—and in electrical circuits there are certain things that impede the flow of currents. Just as we could plot a curve showing the impedance offered to the flow of water due to various amounts of rust in a pipe, so with electrical

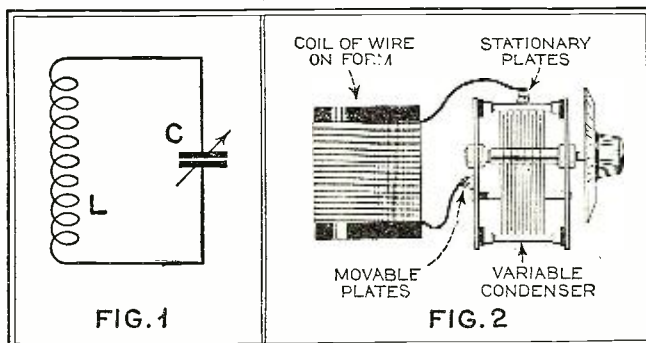

Fig. 1, extreme left, shows a simple tuned circuit. L represents the coil and C the tuning condenser. Fig. 2, to its right, shows in picture form how the parts for such a circuit are arranged





**Open this  
FREE BOOK**  
and you open  
the door to  
**SUCCESS**  
in  
**RADIO**

**YOU**, too, can be trained for a big-time radio job . . . Clip this coupon now and send for this FREE BOOK . . . Read it page by page . . . see for yourself why thousands of fellows just like you are now making from \$50 to \$100 a week . . . why many others earn as high as \$10,000 to \$15,000 a year and even more. This free book gives you 40 fascinating pages of pictures and text, all about RCA Institutes, the only school that is endorsed by the Radio Corporation of America . . . The school that actually sends you radio instruction direct from RCA . . . the very source of radio achievement!

**Easy to Learn Radio  
At Home in Your Spare Time**

Let the RCA Institutes Home Laboratory Training Course give you the real inside facts of radio . . . quickly and easily. Use your spare time to train for success with the remarkable

outlay of screen-grid apparatus given to every student of this course. You learn how to solve every radio problem such as installing, repairing and servicing fine sets. This is the training that will help you to make money in radio!

**RCA Graduates in Big Demand**

For more than 20 years, there has been a well-paid position in Radio waiting for practically every graduate of RCA Institutes. This is a record unequalled by any other school. Only the vast resources of RCA could give you this practical training . . .

**Send for this Free RCA Book  
"Radio . . . the Field  
of Unlimited Opportunity"**

Start today on the road to Success in Radio . . . Send for this FREE BOOK. Every page is packed with pictures and text telling you all you want to know about RCA Institutes, the oldest and foremost Radio training organization in the world. Radio can easily be YOUR ROAD TO SUCCESS . . . That's why you should

**Clip this Coupon NOW!**

**RCA INSTITUTES, INC.**

Formerly  
Radio Institute of  
America



RCA INSTITUTES, Inc.  
Dept. EX-4, 75 Varick Street, New York

Gentlemen: Please send me your FREE 40-page book which illustrates the brilliant opportunities in Radio and describes your laboratory-method of instruction at home!

Name.....

Address.....



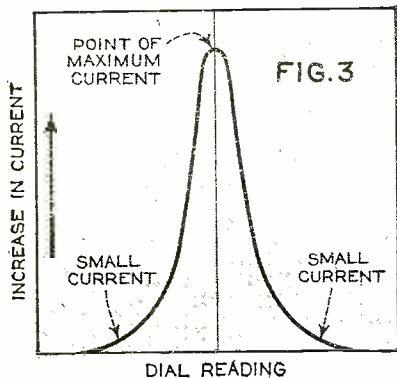

Fig. 3—As a circuit is tuned to a certain frequency the current in the circuit gradually increases to a maximum value and then decreases similarly. A curve of this action would look like that shown to the left

Fig. 4—Capacitive reactance decreases with increase in frequency, while inductive reactance increases. The two curves to the right illustrate this action

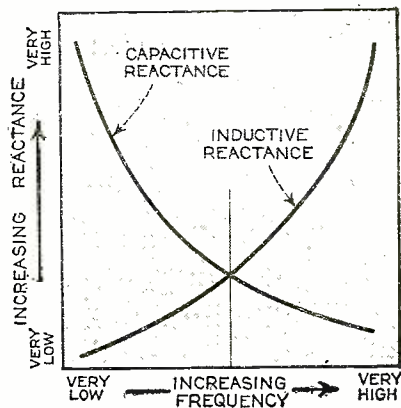

FIG. 4

electrical impedances, as the following will show.

In electrical circuits the three essential types of impedance are resistance, capacitive reactance and inductive reactance—capacitive reactance is the impedance to the flow of current offered by a condenser, and inductive reactance is the impedance to the flow of current offered by a coil of wire. The latter two types of impedance are not constant but depend on the frequency or wavelength of the current—the impedance due to resistance is fairly constant. At very low frequencies the capacity reactance of a condenser is very large and the inductive reactance of a coil is very small. At very high frequencies the capacity reactance is very small and the inductive reactance very large. That is:

The actual value of either the inductive or capacitive reactance is also a function of the size of the condenser or coil—large condensers have *less* reactance than small condensers, large coils have *more* reactance than small coils. We can therefore vary the impedance either by changing the frequency or by changing the electrical size of either the condenser or the coil.

If the variation with frequency of the reactance of a coil and of a condenser is plotted in the form of curves we get the results given in Fig. 4. Now the laws of electrical circuits are such that the impeding effects of a coil and a condenser have opposite effects on a circuit, so that when they are both in the same circuit they tend to nullify each other. The resulting impedance of a circuit to the flow of current is found by subtracting the inductive reactance from the capacitive reactance. This has been done in Fig. 5. Here we note that at one point, "A," the impedance reaches a minimum value, and that at frequencies either higher or lower the impedance rapidly increases. We also can observe the very interesting fact that if we look at this curve upside down it has a form somewhat similar to that given in Fig. 3 where we plotted the current in the tuned circuit. Just as the greatest amount of water will flow through the pipe that offers the least impedance to its flow, so the point of maximum current in a circuit must correspond to the point of minimum impedance.

This is the point that tells us what happens when we tune a receiver. What we are doing is adjusting the capacity to a value such that, at the frequency of the station we desire to receive, the capacitive reactance is exactly equal to the inductive reactance of the coil, so that they cancel each other, the maximum amount of current flows and the signals are loudest.

For those who know algebra, all these facts can be explained by equations. The capacitive reactance is:

$$X_c = \frac{1}{2\pi fC}$$

and the inductive reactance is

$$X_L = 2\pi fL$$

When a circuit is in tune these two effects are opposite and equal. That is

$$\frac{X_c}{1} = X_L = 2\pi fL$$

and transposing and solving for "f" we get

$$f = \frac{1}{2\pi\sqrt{LC}}$$

Since all the factors except C are fixed, in tuning we actually determine the capacity C which satisfies this equation, so that the circuit will be resonant to the frequency "f" of the station we want to receive.

The height of the curve of Fig. 3 depends largely on the resistance of the tuned circuit and practically, the maximum current at resonance in a simple tuned circuit is inversely proportional to the resistance of the coil, for the condenser usually has negligible resistance. Therefore *twice* the coil resistance reduces the current at resonance to *half*; if the coil resistance is reduced by a factor of four the current is four times greater. From the standpoint of getting large currents at resonance it is important to use low resistance coils.

It should be realized, however, that the resistance of the circuit has a marked effect on the current only *at* or *near* the resonant point. At all other points the reactance rather than the resistance determines the current. At a point where the reactance is say of the value of 100 ohms the current will be practically the same whether the coil has a resistance of one ohm or ten ohms. But in most cases we are anxious to get large amounts of current at resonance relative to the currents that flow with the circuit out of resonance and it is for this reason that the coil resistance is important.

Frequency	Inductive Reactance	Capacitive Reactance	Resistance
Very low	Small	Large	Essentially constant
Very high	Large	Small	

Fig. 5—By subtracting the inductive reactance from the capacitive reactance, we find the resulting impedance of a tuned circuit. At "A" minimum impedance is offered by the circuit to the received signal, whereas at points either side of "A" the impedance increases

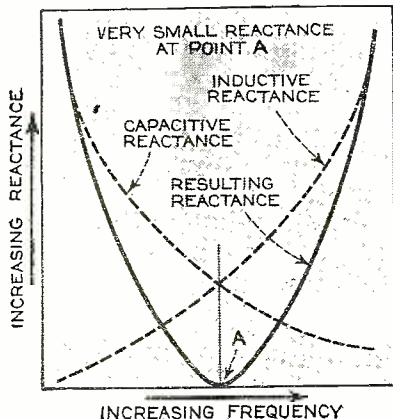

FIG. 5



# YOU CAN "HEAR THE DIFFERENCE AND SEE THE REASON IN EVEREADY RAYTHEON 4-PILLAR TUBES «

HERE is an entirely new type of tube . . . Eveready Raytheon! It combines the highest degree of sensitivity with lasting, rugged strength. The patented Eveready Raytheon 4-Pillar construction—a revolutionary improvement—safeguards fragile elements against the dangers of shipment and handling. Eveready Raytheon elements are assembled on jigs, to put them in most sensitive relation to each other. The 4-Pillar construction anchors these elements where they belong—assuring you of a new standard of reception.

You can see this exclusive construction inside an Eveready Raytheon. Look at the diagram on this page. See the solid, four-cornered glass stem. Notice, imbedded in it, the four sturdy pillars

## 4-PILLAR TUBES

Showing the exclusive, patented EVEREADY RAYTHEON 4-Pillar construction, with its solid, four-cornered glass stem, its four rigid pillars, and anchorage to a stiff mica plate at the top.



supporting the elements. That shows why Eveready Raytheons are stronger than ordinary tubes—and why they give you the best reception you can possibly get from your present receiver. No other tube can be made like this, because the 4-Pillar construction is patented.

Eveready Raytheons come in all types. They fit the sockets in every standard A. C. and battery-operated receiver in use today. They are built by the makers of the famous Eveready Layerbilt "B" Batteries—another radical improvement in radio. Get a set of new Eveready Raytheons from your dealer, and enjoy their reception today.

NATIONAL CARBON CO., Inc.  
General Offices: New York, N. Y.  
Branches: Chicago Kansas City  
New York San Francisco

Unit of  and Carbon Corporation



## 4-PILLAR SCREEN GRID

EVEREADY RAYTHEON SCREEN GRID TUBE, ER 224. The weight of the four large elements in this type of tube makes the exclusive Eveready Raytheon 4-Pillar construction vitally important.



Trade-marks



# RADIO NEWS INFORMATION SHEETS

By Elmore B. Lyford

## Transmission Units

Index No. 621.319.2

**A** TRANSMISSION unit is an expression to denote the ratios of two different powers, voltages or currents in a transmission system (usually telephonic or radio), and both of the transmission units in general use express this ratio in a logarithmic form.

Of the two kinds of units, both of which are in international use, one is based on the Napierian system of logarithms (to the base "e"), and appropriately called the "Neper," and the other is based on the decimal system of logarithms (to the base 10) and called the "Bel." Decimal multiples and sub-multiples of both of these units are also in use, such as the "deci-neper" and the "deci-bel."

The number of transmission units in the case of a ratio of two powers is

$$\text{In the Napierian system } \frac{1}{2} \log_e \frac{P_1}{P_2}$$

$$\text{In the decimal system } \log_{10} \frac{P_1}{P_2}$$

The number of transmission units in the case of the ratio of two voltages or two currents, assuming an equal resistance value for each, and thus making the square of these ratios equal to the power ratio, is—

$$\text{In the Napierian system } \log_e \frac{E_1}{E_2} \text{ or } \log_e \frac{I_1}{I_2}$$

$$\text{In the decimal system } 2 \log_{10} \frac{E_1}{E_2} \text{ or } 2 \log_{10} \frac{I_1}{I_2}$$

The transmission unit which is most in use in this country is the one which is based on the decimal system—the Bel—and having a value of one-tenth of that defined by the above equations. This is the "deci-bel," which is abbreviated "db" and which is often referred to simply as "the Transmission Unit" and abbreviated as "TU." Therefore:

$$\text{db} = \text{TU} = \frac{1}{10} \log_{10} \frac{P_1}{P_2}$$

The following table gives the numerical value of some of the more common power ratios corresponding to particular numbers in decibels:

Power Ratio	Transmission Units in Db.
1. (= 10 <sup>0</sup> )	0 (= 10 log <sub>10</sub> 1)
1.259 (= 10 <sup>0.1</sup> )	1 (= 10 log <sub>10</sub> 1.259)
10. (= 10 <sup>1</sup> )	10 (= 10 log <sub>10</sub> 10)
100. (= 10 <sup>2</sup> )	20 (= 10 log <sub>10</sub> 100)
1000. (= 10 <sup>3</sup> )	30 (= 10 log <sub>10</sub> 1000)

# RADIO NEWS INFORMATION SHEETS

By Elmore B. Lyford

## Vacuum-Tube Nomenclature

Index No. 330.4

**R**ADIO has brought many new expressions into the vocabulary of the broadcast listener. These are used quite freely, but often without a very clear idea of the exact meaning of the terms. Below is given, as simply as possible, the real meaning of the more common of these expressions.

**Amplification Constant, or "Mu."** The most easily understood, and, at the same time, most easily misunderstood term used in connection with vacuum tubes. It is a number which expresses the theoretical maximum of voltage amplification which might be obtained from the tube under ideal conditions. It refers only to the voltage amplifying characteristic, and gives no indication of the power handling capacity of the tube. This theoretical maximum can never be fully attained in practice, but in a well-designed circuit as much as 90% of this voltage gain may be realized.

**Plate Impedance.** This is the impedance, or resistance, in ohms, to an alternating current in the plate circuit of the tube. It is the impedance of only that part of the plate circuit which is within the tube itself, i.e., the space between the filament and plate of the tube. The plate impedance of a vacuum tube varies inversely with the plate voltage used on the tube, but is practically constant at all frequencies.

**Mutual Conductance.** This is a term suggested by Hazeltine in 1918 to serve as the "figure of merit" or an over-all measure of the goodness of a vacuum tube. It is designated as follows:

$$\text{Mutual conductance} = \frac{\text{amplification constant}}{\text{plate impedance}}$$

The higher the amplification factor of the tube is, in general, the better suited it is for radio use, and the lower the plate impedance is, the less of the output will be used up within the tube itself, and the more there will be left to make use of outside, where we want it. From the equation given it may be seen that raising the amplification constant of the tube will make the figure expressing its Mutual Conductance larger, and that lowering the Plate Impedance will have the same effect.

**Micromhos.** The unit used to express the value of the Mutual Conductance of a vacuum tube is the Micromho. Since the unit of resistance is the "ohm," its opposite, the unit of conductance, is called the "mho" (ohm spelled backwards). The Mutual Conductance of any vacuum tube works out as only a small fraction of a mho, so to make it come out in whole numbers it is generally expressed in "micromhos," or millionths of mhos.

Let us take a common example, and see how these terms work out. The accepted value for the amplification constant of a UX201A is 8.5. Its plate impedance with 90-volt plate supply is given as 12,000 ohms. The mutual conductance of such a tube under these conditions, there-

fore, would be  $\frac{8.5}{12000}$  or 0.000708 mhos. This is a diffi-

cult figure to write and to use in computation, so that it is generally expressed as 708 micromhos.



# SM

## Here's a New Amplifier With a Wallop You'll Never Forget!

### The New S-M 692

Power, and more power—more gain than you ever imagined could come out of a three-stage amplifier. Tone quality—a flat curve (within 2 DB) from 60 to 12,000 cycles—within 4 DB from 44 to 13,000 cycles. Set one up—try it—and you'll know why we feel so proud of it!

You'll notice the difference in the "highs"—the usual falling-off around 6,000 cycles simply doesn't start till up around 11,000. Voltage amplification totals 4,000—three times the usual three-stage total! With proper input transformer there is plenty of gain—as high as 90,000—even for "distant" microphone pickup—or 20,000 from a standard phonograph pickup. High resistance input—operate the 692 out of any source of impedance up to 100,000 ohms. Operate it directly into any speaker system—sixteen combinations give output impedances from 8 to 125 ohms—eliminating any possible distortion in speaker transformer.

Test the 692 just once on your oscillator—and you'll use it thereafter as a standard to test your speakers!

Tubes required: 1—'24, 1—'45, 2—'50, and 2—'81.

Price, completely wired, less tubes, \$147, net.

### And the S-M 712—the Ideal Tuner

Just the radio tuner you've been looking for as a feed for that power installation. And what a tuner! All-electric, single-dial (no verniers), pre-selector, power detector, battleship shielding cabinet, individually shielded r.f. coils, and all r.f. circuits individually by-passed and isolated—making the 712 absolutely stable and free from oscillation. And it's absolutely guaranteed to out-distance and out-perform all competition regardless of price.

Tubes required: 3—'24, 1—'27. Wired, less tubes, \$64.90 net. Parts total \$40.90.

The 712 requires separate power supply (2½ volts A, 180 volts B) if used with 692 amplifier. Or S-M 677 amplifier ('45 push-pull, 2-stage) supplies all ABC power required: price, \$58.50 net.

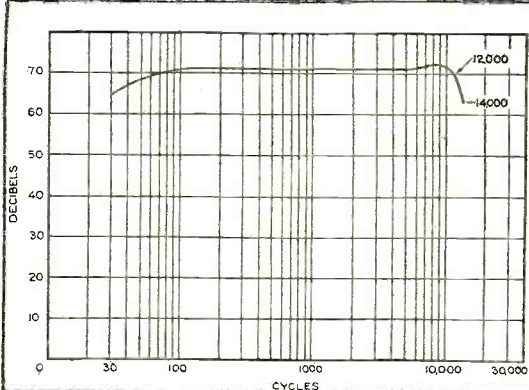
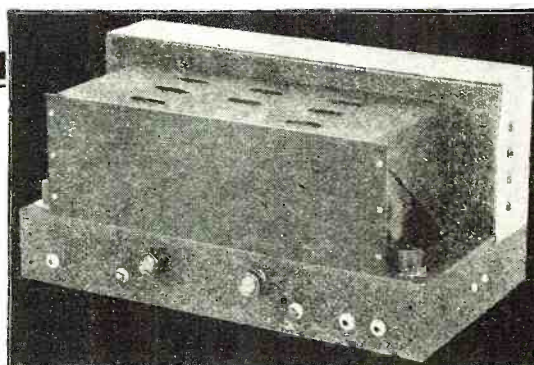

Curve of 692

This curve was not taken at plates of output tubes, but includes output transformer. If input transformer of the speaker is removed, curve shows frequency characteristic as fed direct to speaker.

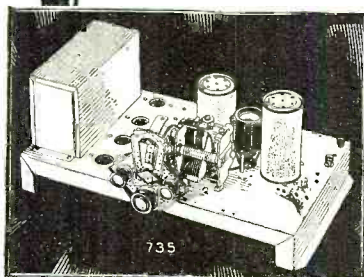

### The S-M 735—Short-Wave "Bearcat"

The first all-electric short-wave set on the American market, the S-M 735 is easily the "bearcat" of them all. Four plug-in coils cover a wave-length range including both amateur and American and foreign short-wave broadcasting (16-6 to 200 meters). Two extra coils extend the wave-length range to cover all American broadcasting. The 735 presents astonishing quality in a remarkably inexpensive receiver. Price, wired, less tubes, \$64.90. Parts total \$44.90. Tubes required: 1—'24, 2—'27, 2—'45, 1—'80.

The Radiobuilder, a monthly publication telling the very latest developments of the S-M laboratories, is too valuable for any setbuilder to be without. Send the coupon for a free sample copy, or to enter your subscription if you want it regularly.

Over 3,000 Authorized S-M Service Stations are being profitably operated. Write for information on the franchise.

**SILVER-MARSHALL, Inc.**  
6405 West 65th Street Chicago, U. S. A.

Silver-Marshall, Inc.  
6405 West 65th Street, Chicago, U. S. A.

Please send me, free, the latest S-M Catalog; also sample copy of The Radiobuilder.

For enclosed \_\_\_\_\_ in stamps, send me the following:

50c Next 12 issues of The Radiobuilder

\$1.00 Next 25 issues of The Radiobuilder

S-M DATA SHEETS as follows, at 2c each:

- ..... No. 3. 730, 731, 732 Short-Wave Sets
- ..... No. 4. 255, 256, etc., Audio Transformers
- ..... No. 6. 740 "Coast-to-Coast" Screen Grid Four
- ..... No. 7. 675 ABC High-Voltage Power Supply
- ..... No. 8. 710 Sargent-Raymont Seven
- ..... No. 9. 678 PD Phonograph-Radio Amplifier
- ..... No. 12. 669 Power Unit
- ..... No. 14. 722 Band-Selector Seven
- ..... No. 15. 735 Short-Wave "Bearcat"
- ..... No. 16. 712 Tuner (Development from the Sargent-Raymont)
- ..... No. 17. 677 Power Amplifier for use with 712
- ..... No. 18. 772 DC Band-Selector
- ..... No. 19. 692 Amplifier

Name \_\_\_\_\_

Address \_\_\_\_\_



# RADIO NEWS INFORMATION SHEETS

By Elmore B. Lyford

## The Three-Element Vacuum Tube

Index No. R-333.1

**D**R. LEE DE FOREST first introduced the third electrode into a vacuum tube in 1907. In the following year an additional patent was granted him covering the construction of this third electrode as a wire gauze or grid, interposed between the filament and the plate—substantially the same arrangement that has been used ever since.

The quantitative effect of this third electrode, or grid, was first set down by H. J. Van Der Bijl in 1913, though its general effect had been explained soon after its discovery.

To understand the effect of this grid, we must first understand the conditions which would exist in its absence. With the filament giving off negative electrons, and the positively charged plate attracting them, there is an electrostatic field between the two. Every point in this field has a definite potential, higher than that of the filament,

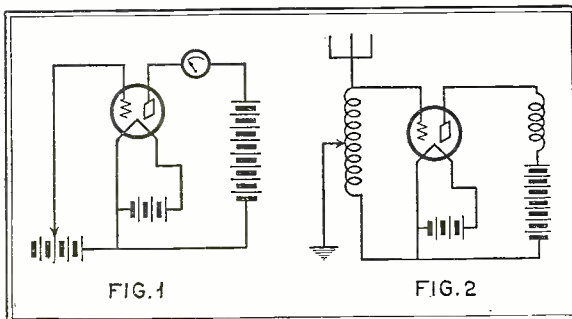

but lower than that of the plate.

When a grid is inserted in this field it will, if left free, first assume the potential of the field at that point. It soon captures some of the passing electrons, however, and assumes a more negative potential, obstructing the flow of electrons by so doing. If we vary this grid potential by a C battery, shown at the extreme left of Fig. 1, we can make the grid oppose the electron flow to any desired degree, and get correspondingly varying plate currents, as shown by the meter.

We use the three-element tube in radio by making the incoming signal voltage vary the grid potential (Fig. 2), instead of by varying the C battery as shown above, and causing it thus to control the plate current of the tube. This plate current is much greater in effect, but the same in electrical form, as the original signal.

# RADIO NEWS INFORMATION SHEETS

By Elmore B. Lyford

## Sensitivity of the Ear

Index No. R-534.4

**T**HE human ear is an extremely sensitive sound-detecting device, but also an extremely erratic one when it comes to detecting sounds of different pitch or frequencies. No two ears have exactly the same "sensitivity curve"—not even the right and left ears of the same person—and the curve of every ear is full of small peaks indicating particular frequencies to which that ear, for some reason, is more than ordinarily sensitive.

In addition to all of this, the sensitivity of the ear varies slightly even from day to day, and considerably over a period of years, and with age. In general, the older a person is, the less sensitive are his ears to the higher frequencies—those above 5,000 cycles.

In view of all of this, it is not surprising that the results

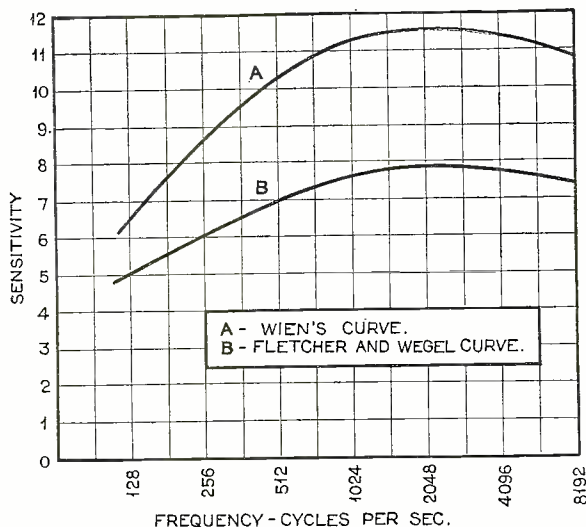

of the many experimenters who have investigated the question of ear sensitivity should be widely divergent. These investigators reach from Lord Raleigh, in 1877, down through Wead, Wien, Webster, Abraham, Kranz and to the work of Fletcher and Wegel in recent years. Of all of these, the average curves of Wien and of Fletcher and Wegel are probably the most significant, and they are the ones reproduced in the accompanying graph, drawn to the same scale.

Wien's curve shows a much greater sensitivity throughout, but the two curves agree in general shape. These are logarithmic curves, so that a sensitivity difference of three units means an energy difference of 1000/1. The curve of Fletcher and Wegel was computed after they had tested both ears of forty-one persons.



# ENJOY A GOOD INCOME!

AND

# TRAVEL IN LUXURY

WITH ALL EXPENSES  
PAID

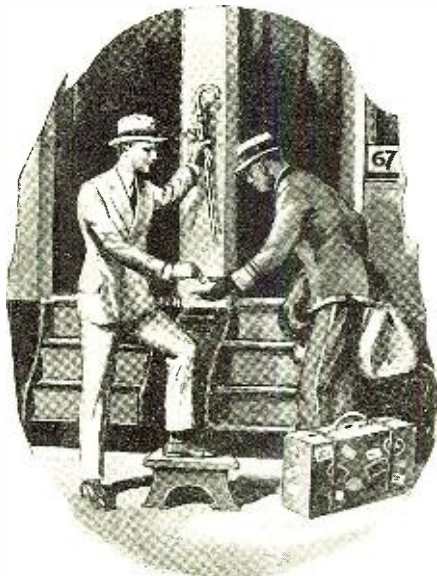

"While working in this country prior to sailing for England Mr. Fisher traveled considerable."

We Have  
Done as Much  
For others—  
We can Do  
the Same For  
YOU

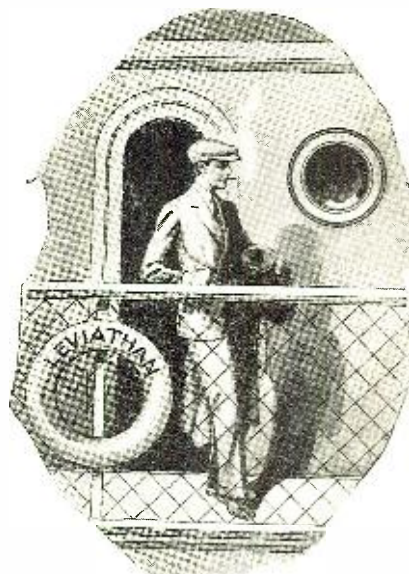

"Mr. Fisher recently left for Europe as a Sound Engineer for a large manufacturer of Sound Equipment in charge of Installation."

OUR GUARANTEE

INSURES YOU

OF FUTURE

INDEPENDENCE

Mr. F. A. Jewell, Gen. Mgr.  
Projectionist Sound Institute, Easton, Pa.

New York City,  
Oct. 21, 1929.

Dear Mr. Jewell:

The training that I received from you has qualified me as an Engineer on Sound-Projection and I am now employed as an Installation Engineer of Sound Equipment, enjoying a nice income and getting a chance to travel over the country, with all expenses paid.

Recently I had the opportunity of accepting a position as Sound-Engineer for a chain of theatres, also a chance to go to England, in charge of installation over there.

I cannot speak too highly of your Institute as a medium for any one with ambition to achieve success in this field.

Sincerely yours,  
HERMAN FISHER.

WE ARE THE  
AUTHORITY AND  
THE EMINENCY OF  
OUR MEMBERS  
IS NOT  
SUBJECT TO  
CONTRADICTION

PROJECTIONIST SOUND INSTITUTE  
EASTON PENNA.

SEND IN THIS COUPON   
RIGHT NOW FOR SPECIAL  
PROPOSITION.

PROJECTIONIST SOUND INSTITUTE, R. N. 4  
P. O. Box No. 28, Easton, Pa.

Gentlemen:  
Please send me, by return mail, full details of your Special Scholarship Prop-  
osition on Sound Projection.

Name .....

Address .....

City ..... State .....



# Radio News Manufactured Receiver Circuits

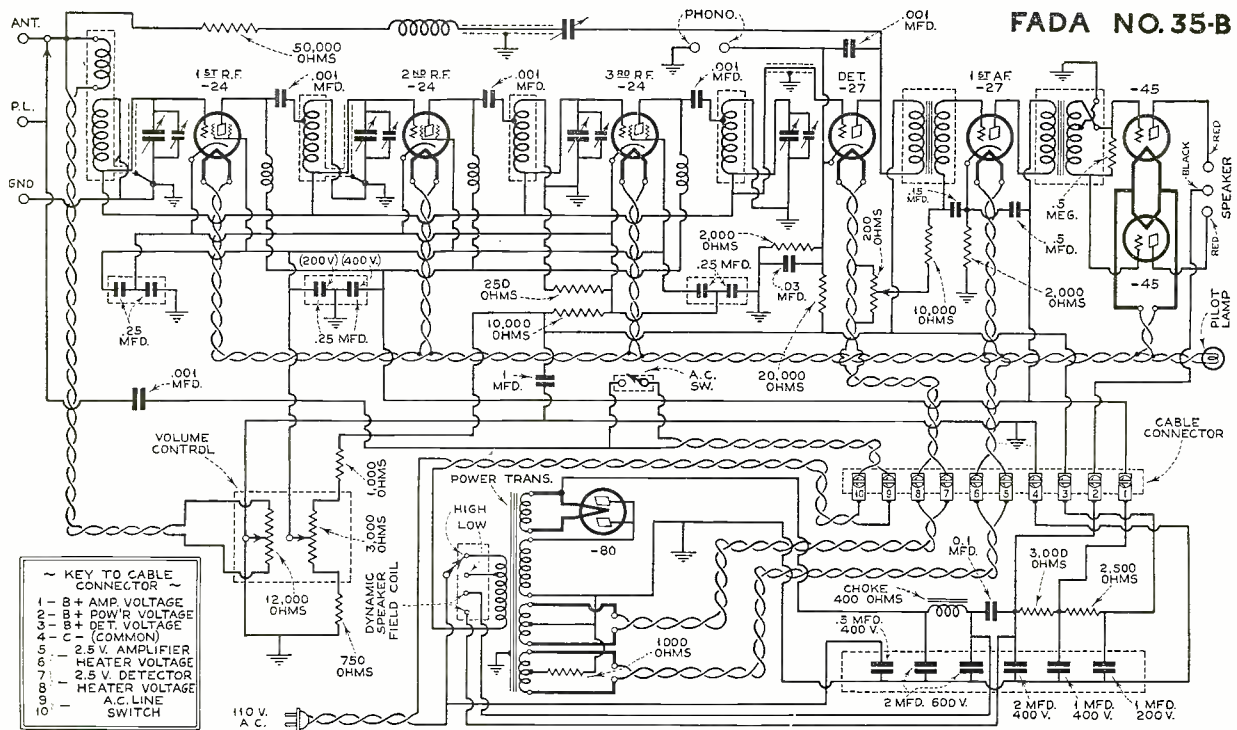

THE Fada No. 35-B receiver, a.c.-operated, embodies the following features:

1. Four tuned, stabilized circuits.
2. Power detection.
3. High quality two-stage audio channel, employing push-pull in the final stage.
4. Eight tubes, as follows: 3 -24's; 2 -27's; 2 -50's; 1 -80
5. Provision for phonograph pick-up attachment.

The receiver, composed of two units, namely, the tuner-amplifier and power supply, is a.c.-operated throughout. Complete circuit details of both units are shown above. Values of resistors, coupling condensers, etc., together with a chart for identifying the various voltage taps on the power unit, are also shown.

THREE stages of tuned radio-frequency, making use of screen-grid -24 tubes, are employed in the Bosch Model 48 radio receiver. The power detector, a -27 indirect heater type tube, is followed by a pair of -45's in a push-pull combination. Due to the extremely high gain obtained in the radio-frequency portion of the receiver, it has been found unnecessary to use the conventional two stages of audio amplification. A -80 tube provides full-wave rectification in the power pack. The power pack has been built into the receiver chassis, eliminating the need of a two compartment console. The current necessary for the excitation of the dynamic speaker field coil is also obtained from the receiver-power supply.

Each of the tuned r.f. stages are individually shielded and bypassed to prevent intercoupling effects.

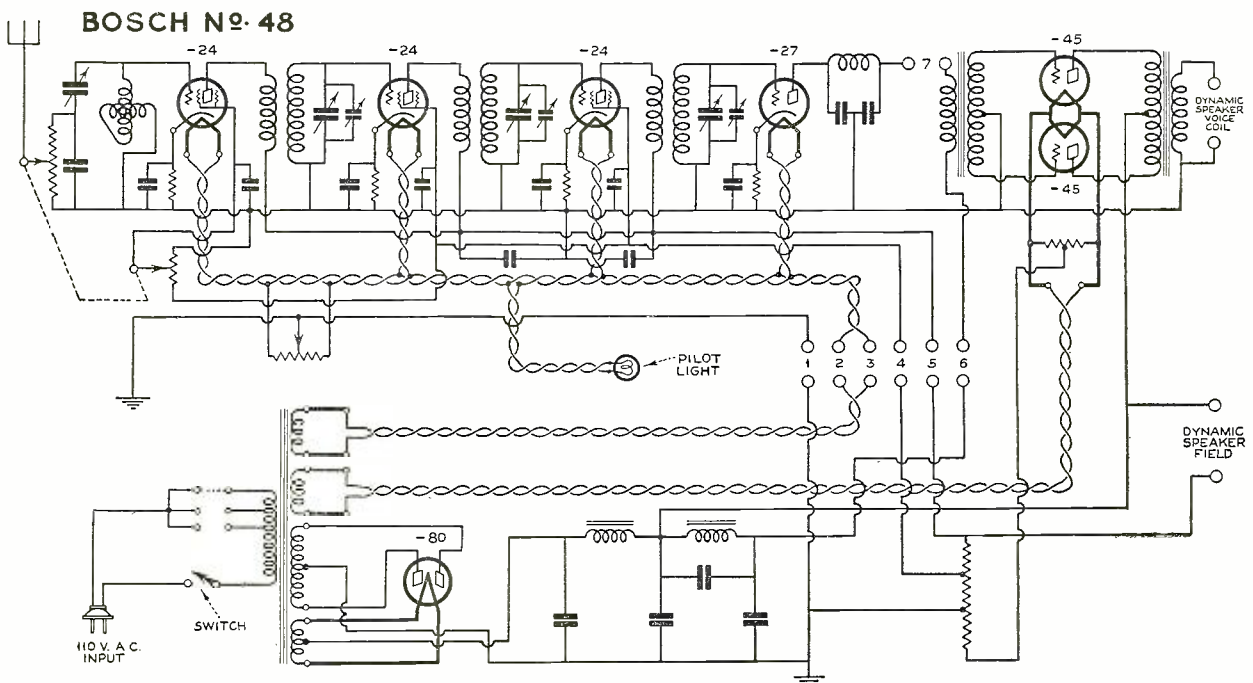



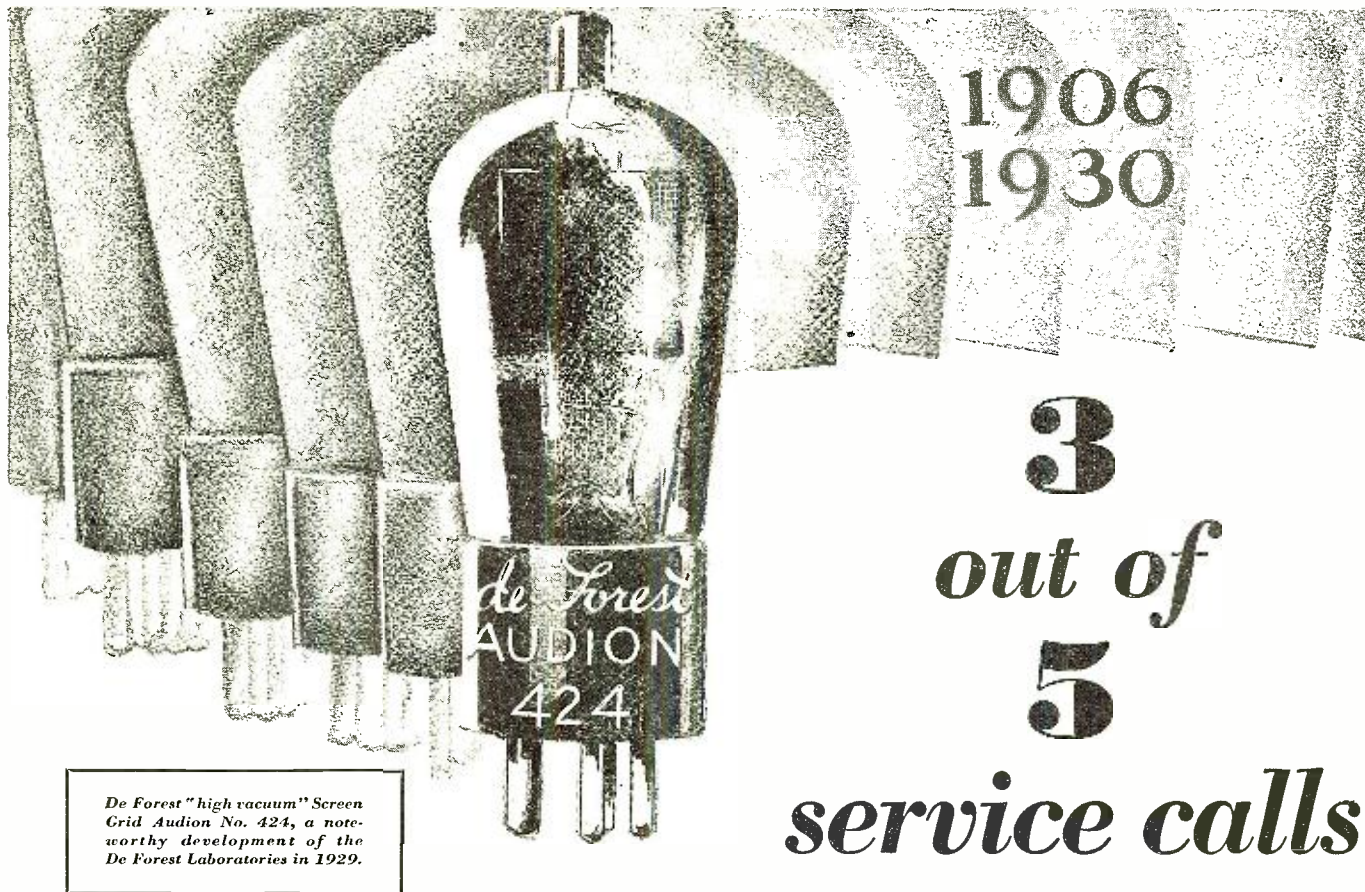

De Forest "high vacuum" Screen Grid Audion No. 424, a noteworthy development of the De Forest Laboratories in 1929.

3  
out of  
5  
service calls

When a set is giving trouble, the service man looks, first, for faulty tubes. And according to a leading magazine devoted to the radio industry—three cases out of five the trouble is *found* in the tubes.

How many calls due to faulty tubes have you had in the past year? What did these calls cost you? It is of the utmost importance for radio set dealers to eliminate these costly calls as far as possible, if full profits are to be enjoyed.

While even the best tubes are not a cure-all for all radio troubles, De Forest Audions,

because of their higher vacuum and sturdy construction, are the acknowledged friends of the service men. As one set dealer told us, "when my men find De Forest Audions in a set, they look for trouble somewhere else."

Service men, who are out on the firing line, can always feel that they have, in De Forest, a backing of complete cooperation. Our Engineering Department is ready at all times to supply data or any specific information bearing on their problems.

Write to our home office and your letter will receive prompt and intelligent attention.

# de Forest AUDIONS



Dr. Lee De Forest, whose invention of the radio vacuum tube in 1906 made radio broadcasting possible.

DE FOREST RADIO CO., PASSAIC, N. J.

Branch Offices Located in

Boston, New York, Philadelphia, Atlanta, Pittsburgh, Chicago, Minneapolis, St. Louis, Kansas City, Denver, Los Angeles, Seattle, Detroit, Dallas, Cleveland



# NEWS from the MANUFACTURERS

## A Traveling Showroom

The Expando Company has developed a highly specialized automobile body for radio selling, manufactured in production for installation on leading automobile companies' chassis. This auto body "Expando" is a specially constructed unit requiring width of only five feet while traveling. The operation of electric power controlled by a single lever, swiftly and smoothly expands the body to ten feet in width, providing ample space for the demonstration of radio sets. The top, which can be raised, combines utility with increased head room, the higher ceiling ensuring greater ease and comfort to the prospective customers. Sliding glass windows are adjustable to any wanted degree for ventilation.

small rooms and is equipped with -24 screen-grid tubes in each of the three amplifying stages, and a single output

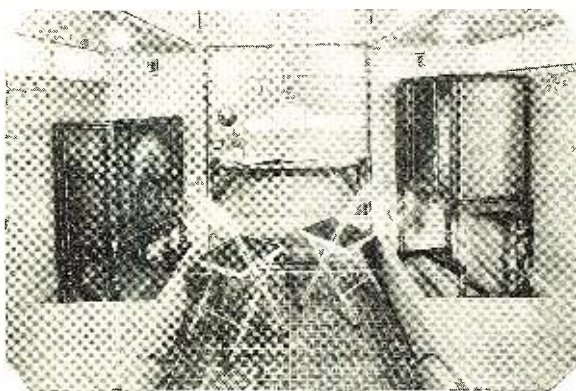

Expando's demonstrating body

## An Electric Pick-up

The Webster Electric Company announces a new pickup, the "2B." It is available in two models, for either battery operated or a.c. sets, and employs the famous low inertia stylus bearing utilizing an all metal pivoting action, eliminating the necessity for bulky construction. Highest grade Cobalt magnet steel providing greatest possible density is used, permitting the pickup head to be extremely small and compact, with the weight of only 4½ ounces on the record, eliminating entirely the need of counterbalancing or springs. Unique features include absorbing arm bearing with pivot at the base, and the turning of the head for conveniently inserting the plain needle, as well as a volume control incorporated in the base.



Webster's phono pick-up, "2B"

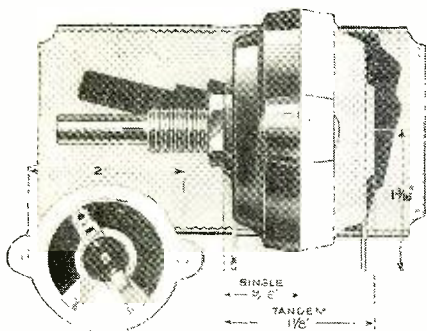

Electrad's tandem resistance control

## High Voltage Volume Control

Electrad, Inc., announces a new Super-Tonatrol Model B, which is particularly adapted for use by manufacturers, because of its compact size and cover arrangement. If desired, two completely isolated circuits may be controlled by one shaft.

An advantage offered by the dual or tandem type Super-Tonatrol is that a tapered resistance can be used in the antenna circuit, and a uniform resistance operated from the same shaft can control the grid circuits. The resistance variation in the antenna circuit is extremely small during the first half of the knob rotation which assures smoother control of powerful signals. Both the single and dual units are available in all the usual resistance ratings or tapered curves dissipating three watts. The Super-Tonatrol is encased in a handsome moulded bakelite cover.

## A New Receiver

According to the Stromberg-Carlson Company, the highest developments in radio apparatus designs for reception from the present-day broadcast stations are included in the new Stromberg-Carlson No. 652 low-type art console. This receiver is particularly suited for modern

stage is made possible by the use of one -45 power tube and a highly efficient loud speaker. A -27 tube is arranged as a linear power detector with automatic bias which is self-adjusted to the proper value for the strength of the signal received.

One of the outstanding features of the No. 652 is the large diameter electrodynamic speaker which employs a non-rattling moisture-proof cone, and is suspended flexibly to give extra sensitiveness. The receiver is operated by three control knobs; a single station selector, a volume control and an off-and-on switch. As in all Stromberg-Carlson receivers, provision is made for using the audio system in conjunction with a pickup for electrical reproduction of phonograph records.



Stromberg-Carlson's receiver No. 652

## A New Volume Control

The Radio Receptor Company of New York, makers of the Powerizer Sound Amplification Systems, announces the inception of a new line of volume controls or faders for sound system use. These volume controls, in all ranges and sizes, are designed for unusually strenuous duty over long periods of time. The Radio Receptor Company has recently announced the perfection of a line of microphones, electrical pickups, dynamic speakers and other components of sound system associate equipment, since the demands made for such devices in public address work is far in excess of the capabilities of conventional radio equipment.

## A Midget Resistor

The tiniest metallized resistor, according to the Engineering Department of the International Resistance Company, is rated at one-third watt and has stood up continuously under loads as high as two watts. The unit, with an overall length of five-eighths of an inch and a diameter of three-sixteenths of an inch, is used in talking picture amplifiers, and is available in ranges from thirty ohms to several megohms. Fifteen units, usually employed in what is known as the fader or attenuation control. Wire leads two inches long facilitate mounting and soldering.



Donald McNicol  
 Past President I. R. E.  
 Fellow A. I. E. E.  
 now  
 Editorial  
 Director  
 of  
 Radio Engineering  
 and  
 Projection  
 Engineering

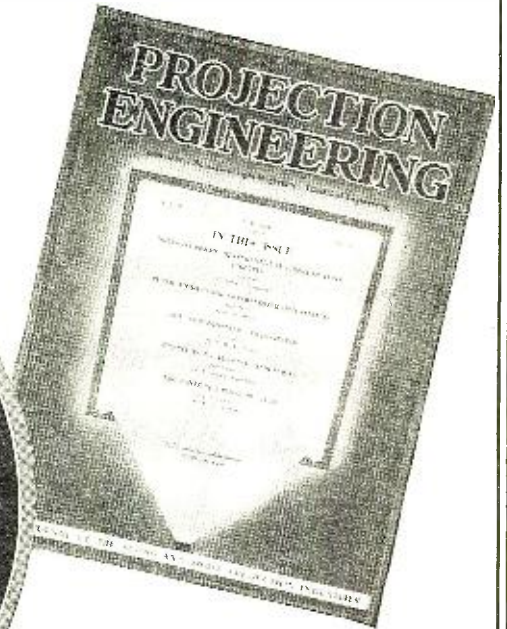

Donald McNicol, Fel. A. I. E. E., Fel. I. R. E., who for some years past has been Advisory Editor of RADIO ENGINEERING and PROJECTION ENGINEERING, will, in March, 1930, actively take up the work of editing these two technical journals.

Mr. McNicol has been closely identified with radio engineering since the beginning of the science in this country, and is a past president of the Institute of Radio Engineers. He is the author of hundreds of technical papers on radio, including the extensive work: *The Engineering Rise in Radio*, which had a wide reading in all parts of the world.

He was for four years chairman of the Committee on Communication, American Institute of Electrical Engineers, and for eight years a member of the publication committee of that Institute. He is internationally known in radio and communication circles and is the author of four standard textbooks on communication subjects.

*Projection Engineering* is published monthly, and deals with engineering developments of sound and light projection, television and theatrical engineering. The manufacture, design, installation and operation of home and theatrical motion picture and talking motion picture apparatus is treated exhaustively.

*Radio Engineering* has been published as a monthly journal for ten years. It covers the broad field of radio manufacture, engineering, testing, servicing, etc. It also treats thoroughly of the various industrial applications of radio and electronic circuits—communication, and experimental television, aeronautical and marine communication, public address systems, etc.

*Neither Publication is sold on newsstands.*

Bryan Davis Publishing Co., Inc., 52 Vanderbilt Ave., New York City.

1. Enclosed find { \$2.00 for 1 yr. } subscription to { Radio Engineering.
2. Enclosed find \$3.00 for one year's subscription to both publications.

Name .....

Address .....

Town and State .....

PLEASE PRINT YOUR NAME AND ADDRESS

Please check your classification.

Manufacturer  
Including executives, plant superintendents, foremen, purchasing agents, etc.

Engineer

Technician

Any other occupation

.....



# The Radio Forum

## The Short-Wave Superheterodyne

Editor, Radio Forum, Sir:

**J**UST a few lines to thank you for the article in the October, 1928, issue of RADIO NEWS, describing the short-wave superheterodyne. I have made four radio-frequency transformers according to your data and hooked them up, and have had excellent results. For example, last evening at 5 o'clock I sat down and tuned in G5SW, in England, and held it till 6:30, changing at that time to KDKA, which I held with excellent volume till 7:40 p.m. Turning on the set again at 8:45, KDKA came back with a real loud-speaker volume, as did KGO at Oakland, California, which is the first time I have heard anything west of Omaha. At 10 o'clock the volume started to build up so greatly that it had to be cut down, staying this way till 2 a.m., when I closed down for the night. After experimenting some time with various detector tubes, I found that the -12A tube as a detector gave much better results than any others.

Thanks for this excellent hook-up.  
Parker Baldwin,  
Tocopilla, Chile.

(EDITOR'S NOTE—Due to the enormous amount of interest in short-wave superheterodynes, we felt that it might be well to repeat what appeared in the "I Want to Know" department in the October, 1928, issue of RADIO NEWS. Here Mr. C. O. Lorenz, of San Antonio, Texas, asks: "Can I make an 8-tube Ultradyne receiver, remove the antenna coil and oscillator coil and replace them with plug-in coils for short waves? Will the oscillator work correctly with these few turns, and could the tickler coil in the modulator circuit be wound to cover all of the short-wave bands? If the Ultradyne circuit will not work correctly in this matter, will you give me the constructional details

for a suitable short-wave superheterodyne, specifying the correct intermediate-frequency amplifier, and giving the values of all the parts used?" The answer to this question follows: "We do not believe that the model L2 Ultradyne would be satisfactory for receiving short waves, since the values of the tuning condensers both in the antenna and oscillator circuits would

placing them with .00015 or .00025 mfd. condensers, and on the broadcast band the set would not operate successfully with the smaller condensers.

We are showing the diagram and specifications for a short-wave superheterodyne which will work very efficiently on wavelengths up to 150 meters. The set was constructed by the writer with a second oscillator coupled, as shown, to the last intermediate-frequency transformer. This was used to receive continuous wave code signals. The set employs four tubes in the radio-frequency section, which would make a total of six tubes in the complete receiver. Three or four stages of intermediate-frequency amplification may be used instead of

the two specified, thereby increasing the radio-frequency amplification and also the selectivity.

This short-wave superheterodyne consists of a short-wave regenerator detector circuit of the usual type, coupled to an intermediate-frequency amplifier, operating on a rather low frequency. When dealing with waves below 125 or 150

meters, the detuning to an incoming signal offered by an oscillator detector is not sufficiently great to cause any appreciable loss in signal strength. For this reason, we can make the first detector self-heterodyning. In this way it can be made to furnish the intermediate-frequency by beating on the incoming signals. This arrangement is similar to that used in the usual superheterodyne, except that with the latter a separate oscillator is used. In Fig. 1 the coils L, L1 and L2 are the primary, secondary and tickler, respectively, of the input circuits. They can be made of almost any form of coil designed for short-wave work. The tuning condenser C1 has a capacity of .00015 mfd.,

and the regeneration control C2 a value of .00025 mfd. The radio-frequency choke coil in the detector plate lead is extremely important, and a very good one should be used. As will be noticed, the grid return of the detector is placed on the minus A battery terminal. It was found that this method gave more faithful operation than the usual cost of returns, although both methods should be tried and the better one used. If one desires to make the radio-frequency choke coil, it can be wound on a half-inch tube with approximately 150 turns of No. 30 to No. 36 double cotton-covered wire, employing either random or slot winding. (Cont'd on page 968)

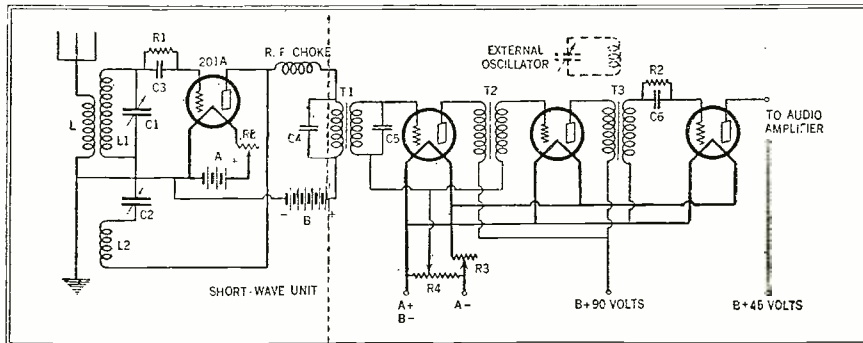

Fig. 1. Circuit diagram of the short-wave tuning unit and intermediate frequency amplifier

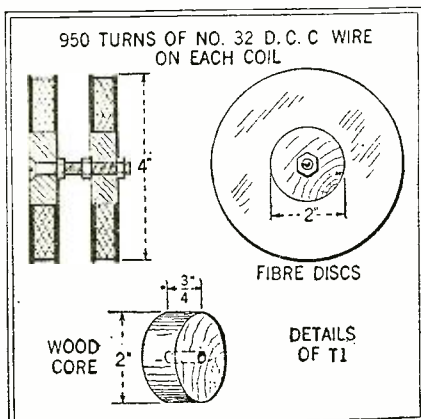

Fig. 2. Details for constructing the filter coupler

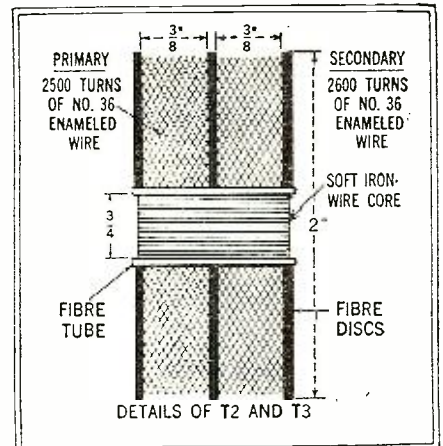

Fig. 3. Cross section view of an intermediate frequency transformer

have to be changed, and we doubt if the oscillator would operate correctly on the various short-wave bands. The .0005 mfd. tuning condensers employed in this set have too great a minimum capacity to be used successfully with the short-wave receiver, and this would necessitate removing them and re-



**Tune In as You Travel**

*(Continued from page 919)*

to get consistent radio reception. This will also offer a means whereby recorded talks describing hotels and points of interest along the company's right-of-way can be featured.

To provide the alternating current necessary a special motor-driven unit is used.

Each radio-equipped car is fitted with headphones for each traveler in addition to a loud speaker for use when required.

Specially arranged programs for train reception are a feature of the Canadian National Railways broadcasting. These include brief summaries of the news, market quotations and baseball scores.

**Current Comment**

*(Continued from page 921)*

development of radio receivers for automobiles, which are just about reaching perfection. It is the desire of these corporations to have their equipment available for the radio automobile market this summer. It is not my purpose to enter into any public argument with you concerning the desirability of automobile radio equipment, but I shall be very pleased to wait upon you at any time you see fit, in order that we may have a chat about this situation and in the meantime, merely suggest that you give some consideration to the serious-minded folks who are bending a real effort to do an outstanding service for your State as well as the others in our country without first letting them present their case to you.

Sincerely yours,  
**ARTHUR H. LYNCH,**  
 Editorial Director.

**Television Through a Crystal Globe**

*(Continued from page 905)*

picture projector, at the broadcasting station.

The receiver consists of a cathode-ray tube especially designed for this purpose. The principles of the cathode-ray tube are well known from their application for oscillographs. The low-potential type of cathode-ray oscillographs is of the sealed-off type, but the amount of light available from the screen is far too small. In order to give sufficient brilliancy for the picture of 5-inch size, the tube should operate at least at 3,000 volts. For larger pictures still higher voltage is required, since the brightness increases with the accelerating voltage. According to these requirements, a new type of cathode-ray tube was developed. This is shown in Figs. 1 and 3. An oxide-coated filament is mounted within a controlling electrode, C. The cathode beam passes through a small hole in the front part of the controlling element and then again through a hole in the first anode, A. The first anode accelerates the electrons to a velocity of 300 to 400 volts. There is also a second anode consisting of a me-

*(Continued on page 954)*

**31**  
*Leaders Choose and Use It!*

LEADING manufacturers use the Mershon Electrolytic Condenser as standard equipment because in extremely **SMALL SPACE** it gives enormous capacity. (72 microfarads in 32 cubic inches.) And because it saves weight, cost, trouble and is **SELF-HEALING!**

You can modernize YOUR radio by using the Mershon. Ask your dealer—or send direct to us for power-pack diagrams, booklets and full information.

**SELF-HEALING**

Mershon Department KC  
 THE AMRAD CORPORATION  
 Medford Hillside, Mass.  
 Please send full information about the Mershon Condenser to:  
 Name .....  
 Address .....



## Here It Is!

The New

# LOFTIN-WHITE

Direct Coupled  
245 Amplifier

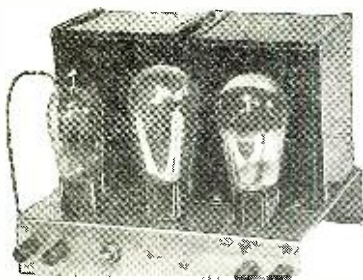

Here is the new and amazing kit put up by Electrad and licensed by Loftin-White. With this kit you can build the new Loftin-White amplifier.

**List Price \$35.00**

Less Customary Trade Discounts

We also have the new

## Amplex

**Loftin-White Licensed Kit**

Completely assembled, ready to wire.

**List Price \$42.50**

Less Customary Trade Discounts

With each kit new data is furnished on "How to Apply the Loftin-White Amplifier to Radio Frequency."

Send your order to us today, as we are the official headquarters for Loftin-White kits.

**Royal-Eastern Electrical  
Supply Co.**

16 West 22nd Street  
New York City

If you have not received our 1930 catalogue, please write for it.

**FREE!**  
**RADIO BARGAIN  
CATALOG**

**ALSO FREE RADIO GIFT**

Send now for this new free radio catalog which saves you many dollars on radio outfits, kits, parts, tubes and accessories! Also TIME CONVERSION CHART FREE. Tells you instantly what time it is in any part of the world! Given free if your request for catalog reaches us this month.

**20th CENTURY MAIL ORDER CORP.**  
200 Jackson St., Chicago, Ill.

Genuine **PILOT** Products

## Exploring Ultra Short Waves

(Continued from page 917)

An interesting effect was noticed when attempting to measure the output of a 10-meter transmitter. In this layout ordinary 43-plate variable condensers which had been doubly spaced were used, and were set near a minimum value. When the coupling coil of the measuring circuit was brought near the inductances in the transmitter the usual deflection was obtained. By placing the coupling coil near one of the condensers used in the oscillating circuit very good deflection could also be obtained. Small values at these frequencies have exaggerated effects, often giving peculiar results. A convenient arrangement to measure the output consists of the antenna ammeter, a small condenser and a one-turn loop connected in series, as shown in Fig. 3. Since power is given by  $I^2R$ , and the resistance can be assumed constant, the power output will vary as the current squared. One should use a very small tuning capacity, otherwise tuning will be too sharp.

Frequency meters for use at 60 mc. can be purchased, but the average experimenter calibrates his own. The simplest calibration arrangement consists of a pair of parallel (Lecher) wires spaced about 2 inches apart. One end of the "line" is shorted and the other end left open. The transmitter is coupled loosely to the shorted end of the line. A grid or plate milliammeter is used in the oscillator for denoting resonance with the wavemeter or wires. When a shorting link of No. 14 copper wire is moved along the wires, definite resonances, as evidenced by abrupt changes in grid or plate current, are noted; these are one-half wavelength apart. By tying small tags at resonant positions on the wires, the distances are easily measured in meters with a meter stick. By multiplying each value by two, the desired wavelength value is obtained. Without disturbing anything the shorting link is removed from the wires, and the wavemeter is coupled to the oscillator and tuned into resonance. The measured value is then noted for the wavemeter scale reading. Usually the shorted end of the wires should not be used as one of the "points." The next two are best. The amplitude of the "peaks" falls off, and they broaden, as the distance from the oscillator is increased, due to line losses, so the accuracy falls off. For any particular wavelength, the wires should be long enough for at least two resonant positions, and a length of at least  $1\frac{1}{2}$  waves is recommended.

The wavemeter is simply a piece of copper tubing or heavy wire fastened to the terminals of a condenser. No indicator is necessary when used with a receiver, the familiar "click method" being employed. If a plate or grid meter is used in the transmitter, the maximum or minimum deflections can be observed when resonance obtains. A flashlight lamp can be used in the tuned circuit of the wavemeter if desired. Such a lamp gives a sensitive indication if operated at the point at which it starts to light. A 2.5-volt size is best for general use. Another arrangement is shown in Fig. 4. Here the "wavemeter coil" is coupled to a loop of wire in series with the flashlight lamp.

When the tuned circuit is at resonance with the oscillator it absorbs power, and thus has associated with it a field which, when sufficiently strong, will light the lamp in spite of the fact that this circuit is untuned. The resistance in the wavemeter circuit is low and the coupling loose, so that a very sharp indication is obtained.

A convenient 5-meter wavemeter is shown in the illustration. The condenser is a 3-plate size with "triple" spacing, covering a range of about  $\frac{1}{2}$  meter at 5 meters. The coil is mounted in the small box (treated in hot paraffin), and is thus protected from damage. The leads pass through small holes in the coil case. The calibration of this wavemeter has remained remarkably constant over a long period of time. A coil consisting of two turns of heavy wire was first employed, but expansion and contraction of the wire changed the calibration. One heavy turn is best.

Since at these frequencies reflectors are small enough to be conveniently used, they will become popular with amateurs. Where is the experimenter who cannot afford the price of two insulators and a length of No. 14 wire to double the signal strength in a given direction? The procedure is to set a simple resonant wire at one-fourth wavelength distance behind the main antenna. It absorbs power and re-radiates it so as to reinforce the radiated wave, in a direction through both wires and from the reflector wire through the transmitting aerial. If a greater directional result is desired, other wires can be supported vertically along a horizontal parabola, the main antenna being at the focus, and the one reflector wire described above arranged at the vertex of the parabola. The transmitting antenna with a single reflector wire will appeal to the average experimenter, as it is a sort of compromise between the simplicity of an antenna which favors no particular direction, and a more complicated directional system. It is a simple matter indeed, to arrange so that this single wire can be rotated around the transmitting aerial as a center, as shown in Fig. 5. Such a system is cheap compared with the price of equipment to double the signal strength at a distant receiver. It causes less interference, and gives better results for a given power. If used at both receiving and transmitting stations, highly reliable communication is possible. A simple 3-wire parabolic reflector gives a gain of about 4, while a more elaborate system may give a gain of about ten times the strength of a simple antenna. When used for reception also, such a system is not a bad radio-frequency amplifier in itself!

Of the plain aeriels, the "zeppelin" type is perhaps the most convenient. Feeder lengths of any odd multiple of a quarter wave can be used, but  $\frac{1}{4}$ -wave feeders are probably more convenient in the usual shack. The feeders can be spaced conveniently by means of the ordinary type of small porcelain insulator. These are spaced about one foot apart, and a piece of cord which is fastened to the roof loops around each insulator, parallels the feeder wires between and is fastened to the floor through a screw-eye. (Cont'd on page 952)



### Amos 'n' Andy

(Continued from page 897)

Seven o'clock, Eastern Time, means 6:00 o'clock Central Time, 5:00 o'clock in the mountains, and 4:00 o'clock on the Pacific Coast. Fans who had become interested in the adventures of Amos 'n' Andy found out that they would either have to give up their jobs or give up Amos 'n' Andy. The storm broke in Denver, where there was virtually a mass meeting of irate listeners. Thousands upon thousands of letters and telegrams of protest were received by the N. B. C. and the sponsors. Something had to be done. The result was that a precedent was established in radio. Amos 'n' Andy continued to go on the air at 7:00 o'clock Eastern Time, but only in the Eastern Time zone. The same evening they went on the air over a Central and Western network at 11:30 P. M. This proved to be the solution of the problem, and while it cost more money there seemed to be no other way out.

Only the President is considered to have right-of-way over Amos 'n' Andy. When it became necessary to eliminate the program for an evening in order to re-broadcast Big Ben in London on New Year's, there were protests. Any rumor that Amos 'n' Andy are going off the air is followed by a flood of letters. Once when the program failed to go on, it was necessary to have the continuity for that night printed in newspapers.

What is the fascination of the program?

Smart showmen declare it is the continuity of interest. They point to newspaper comic strips as an example of the same technique.

Correll and Gosden have ideas of their own.

"It isn't a wise-cracking program," Correll said in discussing their success. Incidentally, both men are somewhat amazed by it all. "People don't listen in because of the jokes that are told. In fact, the program at times has a decided touch of pathos. Amos 'n' Andy are very human. They have more than their share of faults, and they have many likable characteristics. They are always blundering into scrapes and getting out of them. In other words, they are doing what anyone is likely to do under the same circumstances. The comedy is human. The Negro characterization and dialect merely point it more."

Gosden is very proud of the fact that their sketches aren't considered objectionable burlesques by members of the Negro race. The program is as popular with Negroes as with persons of other races. In fact, the belief is current that they really are Negroes, for, it is pointed out, how else could they so thoroughly understand the characters they portray? Both men, however, are decided blonds.

They make public appearances throughout the country and pack the theaters. It is on record that a member of President Hoover's cabinet personally requested that they make an appearance in Washington. They are almost mobbed if by any chance their identity is discovered on the streets or in public places. They get thousands of letters each week, and—well, the boys are good!

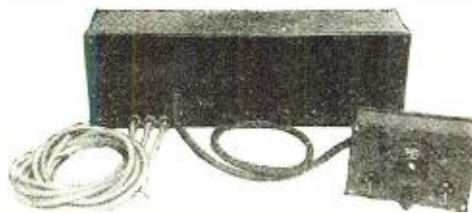

## VOICE OF THE ROAD

A 1930 AUTOMOBILE DEVELOPMENT  
(IN KNOCKED DOWN FORM)

Enjoy those lonesome hours when you're driving alone. Give cheer to those who are driving with you. The "voice of the road" does these and a lot more.

Here is a real automobile radio that will overcome all your difficulties. Here are a few of its accomplishments:

- |  |                               |
|--|-------------------------------|
| 1. 3 stages screen grid R. F.              | 7. Fused A and B lines        |
| 2. Power detector                          | 8. Small for installation     |
| 3. Screen grid 1st audio                   | 9. Highly sensitive           |
| 4. Complete remote control system supplied | 10. Easily installed          |
| 5. Single dial control                     | 11. Can be wired in two hours |
| 6. Shielded cables throughout              | 12. Rugged parts throughout   |
| 13. Ruggedly built with excellent parts    |                               |

Mr. Service Man and Mr. Automobile Mechanic:

Here is a chance to share in the profits that will be realized in the automobile radio field. Send in our coupon to get more facts on the special proposition we have to offer.

-----SEND TODAY-----

CONTINENTAL WIRELESS SALES CORP.  
84 Washington St., Hoboken, N. J.

- Kindly send me your special proposition for set builders
- Kindly send me literature on your audio kit

NAME ..... ADDRESS .....

CITY ..... STATE .....

## BUILT TO GIVE PERFORMANCE-PLUS!

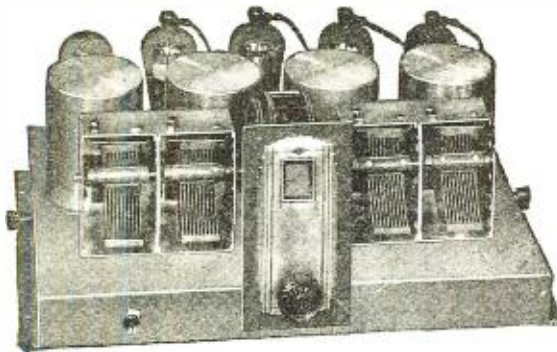

The NATIONAL Velvetone Amplifier Power Supply is an R. C. A. licensed push-pull power amplifier, sold completely wired, and designed for the finest performance with the MB-29.

NATIONAL MB-29 Screen-Grid Tuner is built to give performance-plus.

A new form of power-detection is employed, in which the grid-bias is not modulated by the plate current, thus getting the utmost from the modern high percentage broadcast modulation without loss of sensitiveness.

4 Screen Grid Tubes give great distance, even on a tiny antenna.

Coils are precision-matched to 1-10th of one per cent and the entire tuner is beautifully built on a heavy shielded chassis with wiring concealed in base. The new NATIONAL Projector Dial is supplied as standard equipment. Write us for more complete technical information, mentioning Radio News.

NATIONAL CO., Inc., Malden, Mass.

Est. 1914

# NATIONAL SCREEN-GRID—MB-29



To make the most of  
the sensational

# Loftin- White

Direct-Coupled

## Amplifier

... Use the

### Amplex

Assembled KIT

The Amplex - Loftin - White 245 Kit is authorized and prepared in co-operation with Commander Edward Loftin and S. Young White, inventors.

Completely assembled—each part specially designed—extremely accurate—high overload safety factor—picture diagrams and full instructions.

Successful results are assured with the Loftin-White system as built with the Amplex Kit. Amplex reputation and years of experience as designers and builders of precision equipment recommended and specified by the most prominent radio engineers and technical publications is your guarantee.

**FREE!** coupling plug to connect Amplex Amplifier to any radio set with each assembled LW45 Kit (less tubes).... \$42.50

You will be interested in our pamphlet explaining the **AMPLEX Loftin-White Kit**

### Amplex

Instrument Laboratories  
132 West 21st Street  
New York City  
"Amplification Authorities"

### "Dependable 'B' Battery Power"

For long and short wave receivers. Prices reasonable. Also batteries, A & B operating from 32 and 110 volt farm lighting systems.

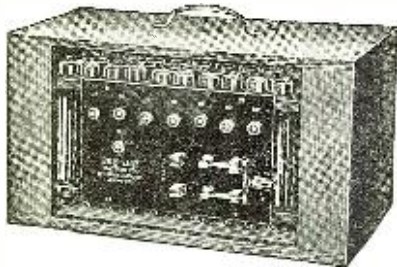

Write for our free interesting booklet. See Jay Battery Co., 911 Brook Ave., N. Y. C.

## Exploring Ultra Short Waves

(Continued from page 950)

The antenna itself is made a multiple half wave long. Although a "full wave" aerial will give higher angle radiation, with the possibility that the signals will return nearer to earth, giving good signals at respectable distances from the transmitter, still a half-wave aerial will probably be the more convenient, especially when used with reflector wires. Long feeders are recommended if, by their use, the antenna can be brought into the clear. The full-wave aerial can usually also be brought more into the clear.

A coupling coil can be used at the transmitter end of the antenna, but it is usually sufficient, at 60 mc., simply to short the ends of the wires. If an antenna meter is used it is connected at the "short."

Each feeder wire should be provided with a "midget" condenser for tuning. Each condenser is adjusted for maximum plate current in the transmitter, or antenna current, and then is readjusted. Parallel-plate or "disc" condensers give sufficient capacity for general use at these frequencies and are simple to construct. They can also be calibrated by applying the simple formulæ for a 2-plate condenser in which the plates are round:

$$C = \frac{2.25 K\alpha}{d \times 10^{10}}$$

## What of the Pentode?

(Continued from page 893)

BY DR. LEE DEFOREST

output and eliminates one stage of radio-frequency amplification. But its disadvantages are many. Of course, many of these disadvantages may be due to the fact that the triode has been more highly developed. Those who favor the pentode point out that by the time the pentode is as fully developed its results will be far superior to those of the triode. Its possibilities, they say, are greater.

The great crowding of broadcasting stations on the air makes the reduction of tuned circuits, which results from the use of the pentode, a distinct disadvantage by lessening selectivity. Moreover, the pentode will cost decidedly more to manufacture. Although the consumer will have less tubes to buy, he will have to pay more for those he purchases. And if but one element burns out the entire tube will have to be discarded. Nor is it easy to manufacture the pentode with uniformity. It is a hard tube to handle, and causes the receiver to misbehave. At least, these have been the difficulties in the past. Maybe they have been met, in one way or another.

With the growing vogue for portable battery receivers the pentode may still find a place in the sun. It may also find use in one-tube transmitters. But for the present and the immediate future, I predict that the pentode will be no thorn in the manufacturer's side, nor any reason for the public to defer the purchase of new radio receivers.

BY GEORGE LEWIS

arrangement. The third grid is connected inside of the tube to the cathode and is commonly referred to as the "cathode grid." This grid, obviously, is

Where C is capacity in microfarads  
k is dielectric constant (1 for air)  
a is area of a plate in sq. inches  
d is distance between plates in inches.

These condensers consist of 2 copper (or brass) plates, soldered to copper tubing connecting leads which are drilled at the ends, fitting over screws on suitable insulators. A convenient size for plates is four inches in diameter. Plates of other sizes can be arranged for plugging in so that the capacity is variable in steps by plugging in the proper plates, and variable over the various ranges by changing the distance between plates. These condensers have very low losses, and the minimum capacity is very small. The minimum capacity of an average "midget" is about three mmfd., whereas the minimum of a disc condenser (3-inch plates) approaches one mmfd. as the plate spacing is increased. A curve showing spacing plotted as abscissæ and capacity as ordinates shows a rapid drop in capacity as the plate spacing is increased, as shown in Fig. 6 (approximate curve for 4-inch plates). For large plate spacings the change in capacity with spacing is very small, giving the effect of a very high-ratio vernier.

at the same potential as the cathode, and has practically no effect on the electrons that have just left the cathode en route to the plate. However, its potential, with reference to the plate, is that of the instantaneous plate voltage, the grid being the negative terminal, with the result that the secondary electrons prefer returning to the plate rather than passing through the cathode grid to the screen grid.

A peculiar thing about this new tube is that the greatest undistorted output can be secured at load impedances considerably below the plate impedance of the tube, rather than at twice the plate impedance, as is the case with the triode. Experimental models require a load impedance of about 6,000 ohms for maximum undistorted power output. Due to the peculiarities of the pentode, high notes are accentuated. Therefore, to strike a balance it should be used in conjunction with a dynamic speaker, because of the latter's accentuation of the low tones. The coupling transformer should, in consequence, have a primary impedance of about 6,000 ohms at 100 cycles and a secondary impedance matching the speaker winding.

It is difficult at this time to venture a guess as to what the commercial possibilities of the pentode may be. The tube will be a high-amplification power tube, selling for a price somewhat in excess of that of the present screen-grid tubes. It will be made in two types—for battery-operated and a.c. receivers. The battery type will have a five-prong base. The a.c. type, likewise, will have a five-prong base and also a cap on the top of the bulb for connection to the control grid.



## Where Are Those Radio Opportunities?

(Continued from page 929)

of the twenty-four. Yet the majority of radio operators spend their spare time in reading cheap detective stories.

Many radio operators have become outstanding successes in radio as well as in other fields. Why? Because they have invested their enormous amount of leisure time to good advantage. Some of these radio operators have become outstanding writers. Others have become editors. Others have become teachers and professors, and still others prosperous business men. Just as many of our outstanding industrial leaders of today have been telegraph operators in their younger days, so many of the industrial leaders of tomorrow are the radio operators of today. Time wisely invested in profitable study builds good executives.

On looking over the jobless radio men we are appalled by their lack of training and experience. The radio industry, fortunately or unfortunately, has advanced to the point where it no longer can afford to experiment with men any more than it experiments with everyday practice. The industry wants men who know, men who can do things, men who can take charge of operations.

We are told that radio factories are closed down, and that many radio men are without work. Let's see. The first thing that we learn is that radio manufacturing organizations retain their good radio men. These men, possessing the practice and secrets of the organization, are always retained as a skeleton force upon which to build the full production personnel when business returns to normal. It is the ordinary help, working with hands rather than brains, that is discharged or laid off. Such help, without special training, can be readily replaced at any time. But good men are rare and are kept working steadily, irrespective of radio conditions. The situation is much the same in any other industry.

Service men, so-called, are perhaps the loudest in bemoaning the bad conditions existing in radio. At least they claim the conditions are bad. Some mention that the salaries average \$20 per week, and the worker must furnish his own car, together with gas, oil and tires, for the weekly stipend. Let's see what the circumstances are with regard to servicing. From leading radio manufacturers we learn that there is a dearth of real radio service men. Of chaps who can insert a new tube, check over the antenna and ground, or make an ordinary installation, there are more than enough to go around. What the industry needs, however, is the service man who is thoroughly trained, well equipped, and can really service sets out in the field without being obliged to send them back to the jobber or manufacturer at the slightest provocation. The industry must have service out in the field, just as in the case of the automobile industry.

Many service men are just tinkers. They cannot undertake continuity tests. They have no equipment other than a screw-driver, pliers and a soldering iron.

(Continued on page 955)

## Your Money Should Buy You GUARANTEED PERFORMANCE

The Lincoln DeLuxe 10 Will Give It To You

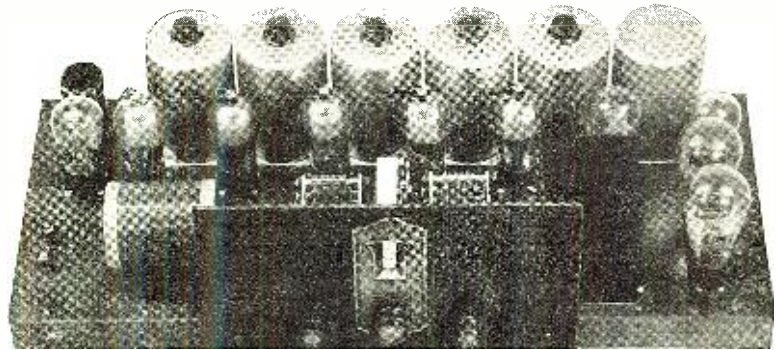

### SELECTIVITY—10 KC From LOCAL POWER—Any Distance—Volume of Local REGISTER—Every channel 550 kc to 1500 kc

Will your receiver, located in Chicago, bring in WABC, WOR, WJZ, KDKA, and WEAJ, all 10 KC from Chicago locals?

That is what the DeLuxe 10 is doing daily on demonstrations and will do the same for you. You can tune stations you have never heard before.

Reports are coming to us of reception from 25 watt stations 3,000 miles away, and 10 watt station in Cuba. The DeLuxe 10 is backing up every one of these claims. Hundreds of people have heard this new receiver actually play one channel after another, each station exploding in clear and loud with NO interference from the 10 KC channel adjoining.

Excerpts from recent letters:

St. Louis, Mo., Feb. 3d.: I have had a great time with the set. It sure is a wonder. I got KXN Sat. night between KRLD and WBAL. KXN was right up against KRLD with quite a dead spot from WBAL. Never had a bit of trouble from KRLD. Had Brownwood, Texas, 100 watt station like a local, 199.9 while WLAC, 201.2 was on the air. Got WCKY, 202.6, KFJF, 204, one after the other.

Santa Paula, Calif.: For just about 10 years I have been building supers. In that time I have used practically every circuit and every make of parts as they have been put on the market. This DELUXE 10 comes nearer meeting my ideas in sensitivity, selectivity, and power than anything I have ever seen. It is not as easy to get distance from the Pacific Coast as some Eastern people would think. Saturday night I logged three stations that I have never heard before, WBZ, WTIC, WOR, and in addition practically every channel with the exception of some of the Canadian and some of the higher frequencies. This is the only radio I have ever seen that will get both adjacent channels to KFI and KXN.

Columbus, Ohio, Jan. 28th.: It is some radio, have logged over 100 stations the past 10 days. You have the happy combination, "Selectivity with tone quality." In the past it was easy to get selectivity but at the expense of quality. It is the only AC set that I can without reservations recommend to my friends.

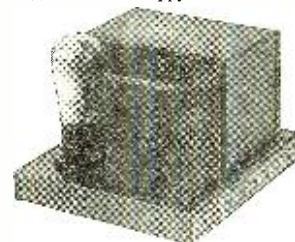

Lincoln DeLuxe B

**SET BUILDERS AND DISTRIBUTORS:** We will prove that you can out-demonstrate any competitive receiver on the American market. Sold strictly through authorized set builders only. All orders handled direct through our office. Write at once for complete information.

### LINCOLN RADIO CORPORATION

Dept. N., 329 South Wood Street, Chicago, Ill.

## BE A RADIO DOCTOR



Radio servicing offers the biggest opportunity for the man interested in radio. About 10,000,000 receivers need service some time or other, many are naturally inefficient and can be improved on.

The Radio Doctors, Inc., is the only institution teaching exclusively radio repairs, having specialized on this phase of radio for a number of years.

**\$3,000 to \$5,000 per year**

The professional "Radio Doctor" receives \$2.00 or \$3.00 per visit and is welcomed in the best of homes—may I tell you more about this new, fascinating and extremely profitable business? Write now for free booklet, "Why the Radio Doctor." (Early inquiries will receive a blueprint of a recent well-known manufactured superheterodyne.)



E. W. PARKER, Pres. RADIO DOCTORS, INC., Dept. N9, 131 Essex Street, Salem, Mass.



## TESTING INSTRUCTIONS FOR SERVICE MEN



Model  
547

### RADIO SET TESTER

This Instrument, and this Manual which is furnished with it, together provide the most complete and up-to-date equipment available for servicing radio receivers. Electrical data for practically every set on the market is contained in this book—which is made up in loose-leaf form so that purchasers of the instrument who turn in registration cards are automatically supplied with latest information.

This instrument has achieved wide success among dealers and service men. It is preferred because of its dependability, ingenious design providing ease of operation, compactness and light-weight portability. It will make all the required tests on any A. C. or D. C. set. Durable bakelite case and fittings. Provided with 3¼" diameter instruments.



WESTON ELECTRICAL  
INSTRUMENT CORPORATION  
615 Frelinghuysen Avenue Newark, N. J.

## Television Through a Crystal Globe

(Continued from page 949)

tallic coating on the inside of the glass bulb. This second anode gives to the electrons a further acceleration up to 3,000 or 4,000 volts. The velocity of the electrons at this is about one-tenth that of light. An important function of this second anode is also to focus electrostatically the beam into a sharp spot on the screen. The target wall of the bulb is about 7 inches in diameter and is covered with a fluorescent material such as will-mite prepared by a special process so as to make it slightly conductive. Conductivity is required to remove the electrical charges from the screen supplied by the electron beam. This tube will be referred to hereafter in this paper as the kinescope.

The beam of electrons can easily be moved across the screen either by an electrostatic or an electromagnetic field, leaving a bright fluorescent line as it passes. For this purpose a set of deflecting plates and a set of deflecting coils are mounted on the neck of the kinescope, outside the tube. The plates and coils are adjusted in the same plane, so as to give vertical and horizontal deflection at right angles to each other. As a result of the location of the deflecting elements between first and second anode, the deflecting field is acting on comparatively slowly moving electrons. Hence the field strength required is much less than that which would ordinarily be used to deflect the beam under the full acceleration of the second anode voltage.

The brightness of the line can be controlled to any desired extent by a negative bias on the controlling element. The bias controls the mean intensity of the picture whose lights and shadows are superimposed upon this mean intensity. It is evident that if we apply to this controlling electrode the amplified impulses from the transmitter and at the same time deflect the beam in synchronism with the motion of the light beam across the picture on the film, the picture will be reproduced on the fluorescent screen. Fig. 2 shows a general view of one type of receiver.

If separate channels are available for each of the synchronizing signals, the problem of synchronization of the receiver with the transmitter is very simple. For horizontal scanning, it is necessary only to transmit the scanning frequency operating the mirror as a sinusoidal voltage and to impress it on the deflecting coils of the kinescope. The cathode beam will follow exactly the movement of the light beam across the film.

For the framing or picture frequency, a voltage is generated at the receiving end and merely controlled by signals from the transmitter. A condenser is charged at constant current through a current limiting device, such as a two-electrode tube, so that the voltage at the condenser rises linearly. The deflecting plates of the kinescope are connected in parallel to this condenser, and therefore, when the condenser is charging, this cathode beam is deflected gradually from the bottom to the top of the fluorescent screen at constant speed. This speed is regulated by the temperature of the filament of the charging tube to duplicate the downward

movement of the film. An impulse is sent from the transmitter between pictures, which discharges the condenser, quickly returning the beam to the bottom position, ready to start upward and reproduce the next picture.

For transmission of the complete picture, three sets of signals are therefore required: picture signals, horizontal scanning frequency, and impulses for framing. It was found that it is possible to combine all of these sets of signals into one channel. In this case the photo-cell voltage of the transmitter is first amplified to a level sufficiently high for transmission. There is then superimposed upon this a series of high audio-frequency impulses lasting a few cycles only and occurring when the light beam passes the interval between the pictures.

The picture frequencies together with the framing frequencies are then passed through a band eliminating filter, which removes the picture component of the same frequency as that of horizontal scanning. Following this, a portion of the voltage which drives the transmitter vibrator is impressed upon the signals, passed through the filter, and the entire spectrum is used to modulate the radio-frequency carrier.

At the receiving station the output of the local radio receiver is amplified and divided by a band-pass band-elimination filter into two parts; one the synchronizing frequency, and the second the picture frequency plus the framing frequency. The synchronizing frequency is amplified by a tuned amplifier which supplies current to the deflecting coils of the kinescope, Fig. 3.

The picture and framing frequencies are applied directly to the control electrode of the kinescope.

The same voltage which modulates the light is impressed upon a band-pass filter, which is tuned to the frequency of the a.c. voltage used for the framing impulses. The output of this filter is amplified, rectified, and used to unbias a discharging triode which is normally biased to zero plate current, and which takes its plate voltage from the condenser which provides the vertical scanning voltage. Thus, the picture signals and both synchronizing and framing frequencies are transmitted on one channel, and fully automatic synchronization is obtained.

Those who are accustomed to the conventional scanning disk type of television notice a number of differences in the appearance of the picture as viewed on the end of the cathode-ray tube. The picture is green, rather than red (as when a neon glow tube is used). It is visible to a large number of people at once, for an enlargement by means of lenses is unnecessary. The framing of the picture is automatic, and it is brilliant enough to be seen in a moderately lighted room.

Technically, the kinescope type of receiver presents added advantages. The high-frequency motor for synchronization, together with its power amplifier, is not required. The power required to operate the grid of a kinescope is no more than that for an ordinary vacuum tube.



**a  
SMOOTH  
start  
and a  
STEADY  
pull**

The giant electric locomotive starts with velvet smoothness and pulls the heaviest loads over steep mountain grades with steady, unflinching power.

It's all a matter of proper control. The increased sensitivity of your radio demands the S-M-O-O-T-H control that only Centralab can give. Noiseless, free of inherent sputtering—self inflated static. For smooth, quiet, velvety radio reception your radio must be CENTRALAB equipped.

Write Dept. 225-G for Free Booklet Volume Controls, Voltage Controls, Their Uses.

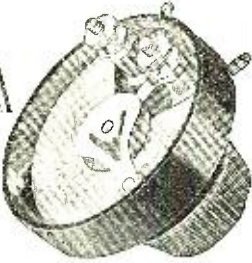

**Centralab**

CENTRAL RADIO LABORATORIES  
Dept. 225-G 22 Keefe Ave. Milwaukee, Wis.

**Radio Opportunities**

(Continued from page 953)

They do not know how to align tuning condensers, improve the selectivity and sensitivity of a super-heterodyne set, and test and replace defective resistors. What they know about radio servicing can be learned in a few days' time. Why, then, should these fellows expect to earn \$35 to \$50 per week? After all, the radio industry competes for men side by side with other industries. If other industries pay only \$20 for men of mediocre training, certainly the radio industry does not have to pay more than that salary—and it doesn't.

How can a good service job be obtained? Well, first of all, a very good basic knowledge of radio, topped by a thoroughly practical experience. Next, it is essential to have the necessary testing equipment, which represents a considerable investment. It should then be possible to service any kind of radio set out in the field, without having to trouble the jobber or the manufacturer except for spare parts and replacements. Of course, the radio dealer who sells on a haphazard basis and is not particularly interested in the future, is not seeking a real service man. What he wants is an errand boy who can deliver and install sets, and check over the obvious troubles. Consequently this dealer offers only \$20 per week and secures all the help he wants. Which, of course, is the fault of the service man, so-called, for not having enough training and equipment, or for tying up with the wrong opportunity.

Many of those who protest are of the opinion that the mountain should come to them. They never think about going to the mountain, which is a surer method of coming to grips with an opportunity. Some are located in small towns, where radio opportunities are obviously few and far between. These individuals bemoan their limited opportunities. Yet is it any different with the lawyers, doctors or engineers? The latter usually go to the big centers in search of big enough jobs to which to apply their education and training. Why radio should be different, we do not understand.

In conclusion might we suggest that the skeptics take a fair and honest inventory of their radio knowledge, radio experience, general education and personality, and then make a survey of the market for these commodities in their own territory. There is entirely too much haste in placing the entire blame on the radio industry at large, while considering the individual entirely blameless. If radio could provide each radio-trained man with a position of leadership, paying a salary fit for a king's ransom, and ask for nothing by way of ambition, enterprise and continued study, all for the small investment of a hundred dollars or so, together with a few months of study, then the entire world would have nothing else but radio. A rather sorry plight, when it is recalled that radio cannot be eaten, worn or used for fuel except in rare instances.

**A GREAT STEP FORWARD...**

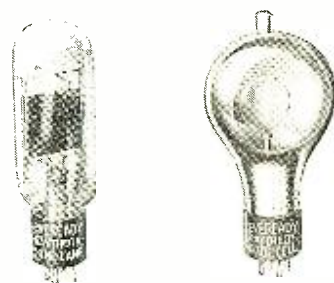

**EVEREADY  
RAYTHEON  
TUBES FOR  
TELEVISION**

THESE television tubes are of proved performance and dependability. The Eveready Raytheon Kino-Lamp, for television reception, is the first tube developed commercially that will work with all systems. Its glow is uniform over the entire plate. Its reproductive qualities are perfect—without the need for mirrors or ground glass. Each tube is tested in our laboratories.

The Eveready Raytheon Foto-Cell is a long-life transmitting tube for talking pictures and television. It is made in several standard types, and can be built to your specifications at reasonable prices.

If you are interested in talking pictures or television—write to us.

**NATIONAL CARBON CO., Inc.**  
General Offices: New York, N. Y.

Branches: Chicago Kansas City  
New York San Francisco

Unit of **UIC** and Carbon  
Union Carbide Corporation



Trade-marks

**Stop  
A.C.  
Noise!**

**Improve  
Selectivity!**

To eliminate "static" from motors, street cars, telephones and electrical appliances, plug in a Falck Claroceptor between wall socket and radio set. This new improvement by a pioneer manufacturer grounds and thus blocks out line interference noise and radio frequency disturbances. Also improves selectivity and distance. Requires no changes in set. Measures just 3½x5½x2½ inches. Thousands all over America now use the Claroceptor for clearer A.C. reception. Get one right away—at radio parts dealers. Write for descriptive folder.

**\$7.50**  
with cord and plug

**Falck  
CLAROCEPTOR**

Manufactured by **ADVANCE ELECTRIC CO.**  
1260 W. Second Street Los Angeles, Cal.  
JOBBER AND DEALERS, GET OUR PROPOSITION





# ELECTRICAL ENGINEERING

BOOKS SENT FREE

New Edition Containing 100 Pages on

## A-C RADIO!

### 8 FLEXIBLE MAROON VOLUMES

4300 pages, 3200 illustrations, deluxe gold stamped binding. Index in each book, general index in Vol. 8. Covers every subject in Electricity—Light, Power, Transmission, Generators, Motors, Switchboards, Radio, Telephone House Wiring, Railways, etc.

We're glad to send a set to your home to examine and use as your own for 10 days—to show you that here is the most up-to-date and complete work on Electricity ever published. Written by CROCKER of Columbia U.—MILLIKAN of Calif. "Tech."—HARRISON of General Electric and 26 other noted Electrical Engineers. Starts off with elementary Electricity in simple, non-technical language for the beginner and includes every Engineering branch for use of experts on the job.

### Complete Electrical Reading Course

Electricity, the biggest industry in the world, continues to grow the most rapidly. And it offers better jobs, bigger salaries and a brighter future than any other field. Every dollar, every hour invested in learning Electricity will come back to you a thousand-fold. Learn in spare time with these books at one-fifth the cost of trade courses. Outline for organized study, quiz-questions and a year's free consulting membership in the American Technical Society included without extra cost, if you mail coupon immediately.

### Look it up!

Thousands of these sets are used as REFERENCE books by men employed in electrical, building construction and allied lines. The JIFFY INDEX puts the answers to 20,000 questions right at your finger tips.

AMERICAN TECHNICAL SOCIETY  
Dept. E-425  
Drexel Ave. & 58th St., Chicago

American Technical Society  
Dept. E-425 Drexel Ave. & 58th St., Chicago

Please send for 10 days' free trial 8-volume set of Electrical Engineering just off the press, subject to return if I wish to. (I pay the few cents express charges on receipt of books, you pay express if returned.) If I decide to keep them, I will pay \$2.00 after 10 days trial, then \$3.00 a month until \$34.80, special advertising price, is paid, after which books become my property. Year's Consulting Membership to be included free.

Name.....  
Address.....  
Employed by.....  
Employer's Address.....

## Ever See a Radio Magazine LIKE THIS?

No advertising, no publicity, no propaganda—just the frank, open mouthpiece of more than 1,000 live-wire radio workers. Join the ELECTRAD FORUM. Dues, \$5 per year, include unique monthly magazine of inestimable value. Write Dept RN4 for details and application blank.

John F. Liden  
DIRECTOR

ELECTRAD FORUM  
1440 Broadway New York

### LEARN TELEGRAPHY WITH TELEPLEX

Be an expert Morse or Continental code operator! BIG PAY—TRAVEL—FUN—ADVENTURE. After a few short weeks of practical study with Teleplex you will be an expert operator. This amazing instrument teaches you right in your own home. Works automatically. No knowledge needed—beginners learn at once! NOT A SCHOOL. Free 10 days' trial. Write for FREE booklet Q-11.



TELEPLEX CO., 72 Cortlandt Street, New York City

## Socket Power for the Boy Scout Four

(Continued from page 933)

transformer to some convenient line wall receptacle, and then turn on the filament supply to the receiver.

It is quite likely that the control knobs on the voltage divider will be found not to be adjusted to the correct position, and will require some adjustment before satisfactory operation of the receiver is obtained. If a high resistance voltmeter is available the job of adjusting the various output voltages to their correct value will be a simple one. Regulation should be made while the receiver is in operation, so that a "load" is offered to the voltage supply device. If no voltmeter is available, adjustment will have to be made by the cut-and-try method, depending upon the ear to indicate when the tubes are functioning correctly and without distortion, by having the proper plate and grid voltages supplied to them.

At troop headquarters or in camp, where 110 volts a.c. is available, the construction and use of the B-C supply device described here will prove of inestimable value in the powering of a receiver such as that described last month.



## Junior Radio Guild

(Continued from page 935)

exactly alike, it will be necessary to apply various plate and grid voltages to the receiver, so that most satisfactory performance is obtained. In our tests we found that approximately 22½ volts were satisfactory when 135 to 180 volts was applied to the plate. However, with the tubes that you use it may be necessary to use either higher or lower values of screen-grid voltage. This can only be found by actual experiment. The same is true of the grid voltage for the final audio stage. If the -12A is used, it will be necessary to use at least 9 volts of C battery; if the -71A is used, then 40½ volts will have to be used. In both cases, the correct plate voltage will have to be employed, namely, 135 volts for the -12A and 180 volts for the -71A. For the first and second audio stages sufficient grid bias is obtained by connecting the return side of the grid resistor to the filament circuit as shown in the circuit. In some instances it may be found well to apply 4½ or even 9 volts to the grid of the first and second audio stages.

### Parts List

- 3 Durham resistors, .25 meg., R1, R3, R5
- 3 Durham resistors, .5 meg., R2, R4, R6
- 2 Carter filament resistors, 20 ohms, R7, R8
- 1 Carter filament resistor, 4 ohms, R9
- 3 Radio Appliance by-pass condensers, 0.1 mfd., C1, C2, C3
- 1 Radio Appliance filter condenser, 1 mfd., C4
- 1 Thordarson output transformer (type to be selected depending on loud speaker used)
- 3 Double resistor mounts
- 3 Eby under-panel UX sockets
- 1 Yaxley loud-speaker terminal block
- 1 box Corwico solid braidite



There's an air of hospitality that you'll like

AT THE HOTEL  
**PICCADILLY**  
227 WEST 45th St. of BROADWAY  
NEW YORK

ADJACENT TO EVERY ACTIVITY  
600 BRIGHT SUNLIT ROOMS  
EACH WITH BATH, ELECTRIC FAN, ICE WATER  
SINGLE ROOM 4/6 BATH \$3.00  
DOUBLE ROOM 4/6 BATH \$4.00

Exceptional Restaurant & Grille  
WIRE AT OUR EXPENSE FOR RESERVATIONS  
F. D. SOFIELD - MANAGING DIRECTOR

## A GENUINE 240 POWER MICROSCOPE!

Sent for Only \$1.00 DOWN

An educational and entertaining instrument that enables all to see and know life invisible to the naked eye. Thrills and fun galore! See tiny bugs grow to proportions of great elephants. See plant and mineral life reveal amazing wonders in form and color. Made just like microscopes used by physicians, scientists, etc. Now only \$3.98. Could easily sell for \$70 and \$20 more. Adjustable lens of 240 power! Send only \$1.00. Pay balance (\$2.98 plus postage) when postman delivers. If not satisfied return within 5 days and your money will be promptly refunded.



### Ideal for Students!

A wonderful help in studying science, botany, etc. Never before has such a wonderful instrument been offered at such an amazingly low price of \$3.98.

DEALERS AND TEACHERS WRITE FOR OUR PROPOSITION!

R. B. SPECIALTY COMPANY  
Dept. D-340 220 E. 3rd St., Cincinnati, O.



Boys! Here's the great NAVY model Airship. Large 6-foot air bag with inflators, parachute with automatic release and complete instructions for flying. Will fly for miles at height of 1000 feet. Great chance to study aerial navigation. Send name and we'll send you our new air picture to dispose of on special 25c offer. Send the \$1.50 you collect and as a reward for this service we will send this wonderful Airship with full instructions free.

C. M. THOMAS, 337 W. Madison St., 4-K-22, Chicago

## ELECTRIFY YOUR RADIO FOR ONLY 68¢ COMPLETE

Why discard your present good set when you can electrify it for only \$6.85, and banish the annoyance and expense of buying new "B" batteries?



### Over 150,000 Townsend "B" Power Units In Use

Hooked up in a few minutes. Use same tubes—no changes. You'll be amazed at the improvement in reception and distance getting. Send name and address today for full details, proof and Free Trial Offer.

TOWNSEND LABORATORIES  
725 Townsend Street Chicago, Illinois

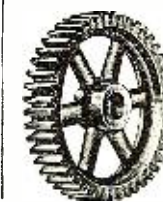

## GEARS

In stock—immediate delivery Gears, speed reducers, sprockets, thrust bearings, flexible couplings, pulleys, etc. A complete line is carried in our Chicago stock. Can also quote on special gears of any kind. Send us your blue-prints and inquiries.

Write for Catalog No. 40  
CHICAGO GEAR WORKS  
769-773 W. Jackson Blvd., Chicago, Ill.



"An Address of Distinction"



One of the World's Great Hotels

OUTSTANDING not only among the hotels of Chicago . . . but among all the hotels of the World. Costs compare favorably with other establishments where distinguished standards of service prevail. Rates begin at \$5 per day. Permanent Suites at Special Discounts.

THE **DRAKE** HOTEL, CHICAGO  
Under Blackstone Management

**SUPER - WASP SHORT-WAVE AC & DC RECEIVER**

In Kit Form or Completely Constructed

**1930 Catalog FREE**

Set Builders! Write for your copy. Complete line of short wave supplies, standard parts and accessories

CHICAGO RADIO APPARATUS CO.  
415 S. Dearborn St., Dept. RN  
Chicago, Ill.

**QUIT TOBACCO**

Don't try to banish unaided the hold tobacco has upon you. Thousands of inveterate tobacco users have, with the aid of the Keeley Treatment, found it easy to quit.



**KEELEY TREATMENT FOR TOBACCO HABIT** Quickly banishes craving for tobacco. Successful for over 50 years. Write today for FREE BOOK and particulars of our MONEY-BACK GUARANTEE.

THE KEELEY INSTITUTE, Dept. L-602, Dwight, Ill.  
Home of the famous Keeley Treatment for Liquor and Drugs. Booklet Sent on Request. Correspondence Strictly Confidential.

**PATENTS**

As one of the oldest patent firms in America we give inventors at lowest consistent charge, a service noted for results, evidenced by many well known patents of extraordinary value. Book, Patent-Sense, free.  
Lacey & Lacey, 631 F St., Wash., D.C. Estab. 1869

**NEW SCOTT A-C SHIELD-GRID 10**

If you have a critical ear, you will know Quality, you will want to enjoy the best in Radio. You owe it to yourself to find out!

Owing to my place of business my prices are the lowest at all times. Orders taken from anywhere.  
Tel. Astoria 8965 Write today

**DEMONSTRATION--DAY--NIGHT--SUNDAYS**

**NICHOLAS CHIVILY**

Exclusively Custom Built Receivers  
(Apt. 9.) 3456-33rd St., Astoria, N. Y.

Close to Washington Ave. Sub. Station, Astoria

**HAMMARLUND HiQ-30**

**Eliminating the Hum**

(Continued from page 904)

be used singly or in series with others of the same or of different types. If the condenser across the rectifier be omitted, an additional advantage is obtained in that the rectifier load due to such a condenser is greatly reduced, and the rectifier tube life prolonged. In a particular very popular receiver using a two-microfarad condenser in this position, and having a filter output direct current of 70 milliamperes, the a.c. current through this input condenser was also 70 milliamperes, thus doubling the load on the rectifier tube. Another valuable advantage of the tap choke filter is therefore evident. I have developed many modifications of this arrangement wherein choke coils of successive filter stages are coupled for hum reduction; and wherein filter chokes are coupled to audio transformers or other audio-frequency coupling devices for the same purpose, and having the same general effect.

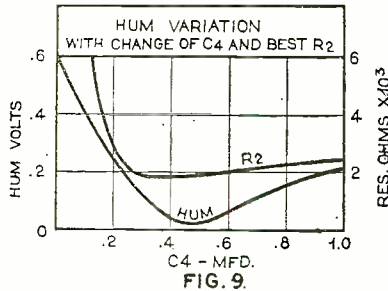

Hum voltage may be computed from these curves which were made using the circuit in Fig. 8

**Neutralization by Hum Feedback**

Another method of hum neutralization, which I term "hum feedback," is capable of very surprising results. It is used not in the filter, but in the receiver circuit. The circuit arrangement as applied to a single tube or group of tubes obtaining plate and grid-bias voltages from the same points, such as the first audio and all-radio tubes as a group, is shown in Fig. 7.

Here a tube is shown with input and output coupling devices. B voltage being obtained from the receiver filter output, and C voltage being obtained from the voltage drop, produced across the grid

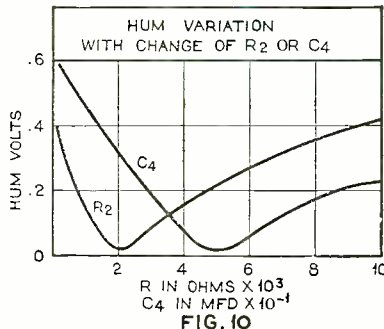

These two curves show the resistance and condenser tolerances with a neutralizing factor of approximately 60

bias resistance R by the plate current of the tube. A condenser C is connected across this resistance for signal by-pass, first to keep this resistance out of the  
(Continued on page 939)

"Here at last is THE BOOK that we of the Radio profession have needed for a long time. It is the best and most complete handbook ever published," says J. H. Bloomenthal, Chief Radio Operator, U. S. S. B. Steamship "East Side."

**THE RADIO-MANUAL**

A New Edition

Complete new chapters on aircraft radio equipment; Practical Television and Radiomovies with instructions for building a complete outfit; radio interference; 100% modulation; latest equipment of the Western Electric Co.; the Marconi Auto-Alarm System; and many other developments of the past year. All this information is added in the new edition and, besides, the entire book has been brought right up to date with much new material. The Radio Manual continues to be the one complete and up-to-the-minute handbook covering the entire radio field.

A Handbook for Students Amateurs Operators Inspectors



20 big chapters cover: Elementary Electricity and Magnetism; Motors and Generators; Storage Batteries and Charging Circuits; The Vacuum Tube; Circuits Employed in Vacuum Tube Transmitters; Modulating Systems and 100% Modulation; Wave-meters; Piezo-Electric Oscillators; Wave Traps; Marine Vacuum Tube Transmitters; Radio Broadcasting Equipment; Arc Transmitters; Spark Transmitters; Commercial Radio Receivers; Marconi Auto-Alarm; Radio Beacons and Direction Finders; Aircraft Radio Equipment; Practical Television and Radiomovies; Eliminating Radio Interference; Radio Laws and Regulations; Handling and Abstracting Traffic.

An immense amount of information never before available including detailed descriptions of standard equipment is presented.

**Prepared by Official Examining Officer**

The author, G. E. Sterling, is Radio Inspector and Examining Officer, Radio Division, U. S. Dept. of Commerce. The book has been edited in detail by Robert S. Kruse, for five years Technical Editor of QST, the Magazine of the American Radio Relay League. Many other experts assisted them.

**Free Examination**

The new edition of "The Radio Manual" has just been published. Nearly 800 pages, 369 illustrations. Bound in Flexible Fabrikoild. The coupon brings the volume for free examination. If you do not agree that it is the best Radio book you have seen, return it and owe nothing. If you keep it, send the price of \$6.00 within ten days.

Order on This Coupon

D. Van Nostrand Co., Inc., 250 Fourth Ave., New York

Send me the Revised edition of THE RADIO MANUAL for examination. Within ten days after receipt I will either return the volume or send you \$6.00, the price in full. RN-4-30

Name .....

St. & No. ....

City and State .....

Business Connection .....



# The Most Complete Radio Book Service!

Your Opportunity to Obtain Any of the Outstanding Volumes from One Source

## "AUDIO POWER AMPLIFIERS"

By J. E. Anderson, M.A., and Herman Bernard, LL.B.

The First and Only Book On This Important Subject

IN radio receivers, separate audio amplifiers, talking movies, public address systems and the like, the power amplifier stands out as of predominating importance, therefore a full and authentic knowledge of these systems is imperative to every technician. "Audio Power Amplifiers" is the book that presents this subject thoroughly. The authors are:

J. E. Anderson, M.A., former instructor in physics, University of Wisconsin, former Western Electric engineer, and for the last three years technical editor of "Radio World."

Herman Bernard, LL.B., managing editor of "Radio World."

They have gathered together the far-flung branches of their chosen subject, treated them judiciously and authoritatively, and produced a volume that will clear up the mysteries that have perplexed many. The book begins with an elementary exposition of the historical development and circuit constitution of audio amplifiers and sources of powering them. From this simple start it quickly proceeds to a well-considered exposition of circuit laws, including Ohm's laws and Kirchhoff's laws. The determination of resistance values for produce required voltages is carefully expounded. All types of power amplifiers are used as examples—AC, DC, battery operated and composite. But the book treats of AC power amplifiers most generously, due to the superior importance of such power amplifiers commercially.

"Audio Power Amplifiers" is for those who know something about radio. It is not for novices. But the engineers of manufacturers of radio receivers, power amplifiers, sound installations in theatres, public address systems and phonograph pickups will welcome this book. Engineers—even chief engineers—of the Bell Telephone Laboratories, Radio Corporation of America, Westinghouse Electric & Mfg. Co., Western Electric, Photophone, Vitaphone and the like needn't be afraid they won't learn something from this little book.

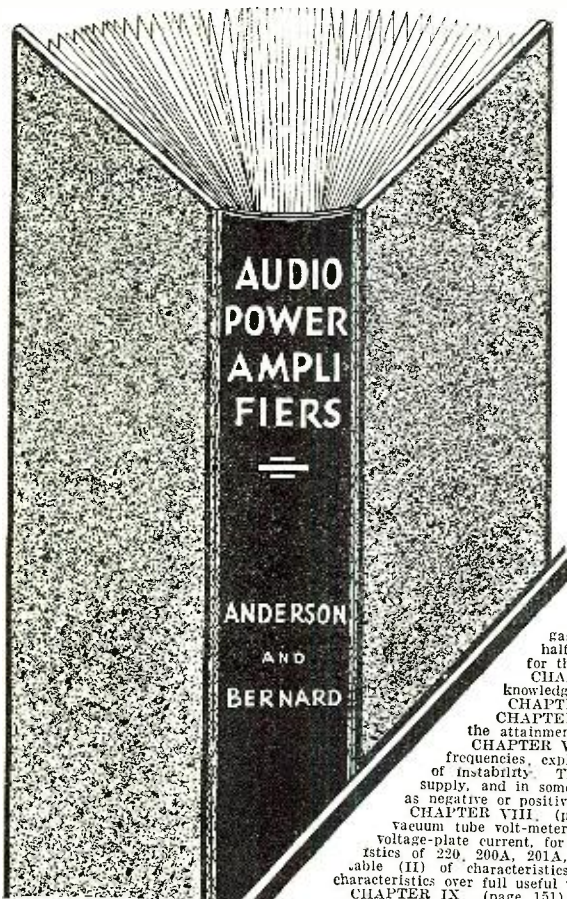

## Details of Chapter Contents

CHAPTER I. (page 1) General Principles, analyzes the four types of power amplifiers, AC, DC, battery operated and composite, illustrates them in functional blocks and schematic diagrams, and treats each branch in clear textual exposition.

CHAPTER II. (page 20) Circuit Laws, expounds and applies Ohm's laws and their special form known as Kirchhoff's Laws.

CHAPTER III. (page 35) Principles of Rectification, expounds the vacuum tube, both filament and gaseous types, electrolytic and contact rectifiers, and explains why and how they work. Full-wave and half-wave rectification are treated, with current flow and voltage derivation analysis. Regulation curves for the 250 tube are given. Voltage division, filtration and stabilization are fully illustrated and dissected.

CHAPTER IV. (page 62) Practical Voltage Adjustments, gives the experimental use of the theoretical knowledge previously imparted. Determination of resistance values is carefully revealed.

CHAPTER V. (page 72) Methods of Obtaining Grid Bias, enumerates, shows, and compares them.

CHAPTER VI. (page 90) Principles of Push-Pull Amplifier, defines the push-pull relationship, with keys to the attainment of desired electrical symmetry.

CHAPTER VII. (page 98) Oscillation in Audio Amplifiers, deals with motorboating and oscillation at higher audio frequencies, explaining why it is present, stating remedies and giving expressions for pre-determination of regions of instability. The trouble is definitely assigned to the feedback through common impedance of load reactors and B supply, and in some special instances to the load's relationship to the C bias derivation as well. The feedback is shown as negative or positive and the results stated.

CHAPTER VIII. (page 118) Characteristics of Tubes, tells how to run curves on tubes, how to build and how to use a vacuum tube volt-meter, discusses hum in tubes with AC on the filament or heaters and presents families of curves, plate voltage-plate current, for 240, 220, 201A, 112A, 171A, 227 and 245, with load lines. Also, plate voltage-plate current characteristics of 220, 200A, 201A, 171A, 222, 240, 226, 227, 224, 245, 210, 230, full data on everything. There is a composite (II) of characteristics of Rectifier and Voltage Regulator Tubes, and individual tables, giving grid voltage, plate current characteristics over full useful voltage ranges for the 220, 201A, 112A, 171A, 222, 245 and 224.

CHAPTER IX. (page 151) Reproduction of Recordings, states coupling methods and shows circuits for best connections.

CHAPTER X. (page 161) Power Detection, explains what it is, when it should be used, and how to use it. A rectifying detector, designed by one of the authors, is expounded also.

CHAPTER XI. (page 121) Practical Power Amplifier, gives AC circuits and shows the design of a sound reproduction system for theatres. A page is devoted to power amplifier symbols.

CHAPTER XII. (page 183) Measurements and Testing, discloses methods of qualitative and quantitative analysis of power amplifier performance. Order Cat. APAM.

## Two Other New Books by the Same Authors

"The Superheterodyne," a new volume, deals with the theory and practice of this receiver in a detailed and pertinent manner, fully illustrated. The theoretical discussion proceeds to a receiver embodying the theory stated. Full constructional data. Order Cat. ABSH.

"Foothold on Radio," for the sheer novice, the only book published that is really for the person who knows nothing about radio. Fully understandable by any one. Freely illustrated. Order Cat. FOR.

## "Trouble Shooter's Manual"—"Mathematics of Radio"

The three books by John F. Rider, Institute of Radio Engineers, are "Mathematics of Radio," "Trouble Shooter's Manual," and "Treatise on Testing Units for Service Men."

"Mathematics of Radio," 128 pages, 8 1/2 x 11", 119 illustrations, bridges the gap between the novice and the college professor. It gives a theoretical background so necessary for a proper understanding of radio and audio circuits and their servicing. Flexible cover. Order Cat. MOR.

"The first comprehensive volume devoted exclusively to the topic uppermost in every service man's mind is "Trouble Shooter's Manual," just published. It is not only a treatise for service men, telling them how to overcome their most serious problems, and fully diagramming the solutions, but it is a course in how to become a service man. It gives all the hints that have never been given before. Finding the right mode of attack, applying the remedy promptly and obtaining the actual factory-drawn diagrams of receivers always have been a big load on the service man's chest. But no more.

This book is worth hundreds of dollars to any one who shoots trouble in receivers—whether they be factory-made, custom-built or home-made receivers.

MORE THAN 100 WIRING DIAGRAMS OF RECEIVERS MADE BY MORE THAN FORTY DIFFERENT SET MANUFACTURERS ARE PUBLISHED IN THIS BOOK, INCLUDING OLD MODELS AND LATEST MODELS! RCA, ATW, REX, CROSLEY, MAJESTIC, ZENITH, STRONG, CARLSON, KOLSTER, FEDERAL, FADA, ETC. 240 pages, size 8 1/2 x 11"; 200 illustrations. Imitation leather cover. Order Cat. TSM.

"Treatise on Testing Units for Service Men," is a 43-page, liberally illustrated book on testing units and circuits. Tells what equipment a service man should have and how to use it most effectively and quickly. Rapidity of operation is one of the points stressed throughout this valuable book, as a service man's time is his chief stock in trade. Order Cat. TTC.

## Other Books

"ABC of Television," by Raymond Francis Yates, tells the whole story and gives data on construction of a television receiver. 210 pages, 100 illustrations. Cloth bound. Order Cat. TEL.

"The Radio Manual," by G. E. Sterling of U. S. Dept. of Commerce and Robt. S. Kruse, formerly technical editor of QST, nearly 900 pages, 369 illustrations. Bound in flexible fabricoid. Order Cat. MAN.

"Drake's Encyclopedia," new edition, 2 1/2" thick, weighs 3 1/2 lbs., 920 pages, 1,025 illustrations. Order Cat. DRA.

"Experimental Radio," by R. R. Ramsey, Ph.D., Prof. Physics, Indiana University, 255 pages, 168 illustrations. Cloth cover. Order Cat. REX.

"Fundamentals of Radio," by Ramsey, 372 pages, 402 illustrations. Order Cat. RFM.

"Principles of Radio," by Keith Henney, M.A., director, laboratory, Radio Broadcasters, 477 pages, 305 illustrations. Order Cat. PRK.

"Radio Telegraphy and Telephony," by Rudolph L. Duncan and Charles E. Drew, of Radio Institute of America. Order Cat. RTT.

"The Superheterodyne," by R. E. Lacautil, 93 pages, 68 illustrations; cloth cover. Order Cat. REL.

## "Elements of Radio Communication"

The latest book by Prof. John H. Morigoff, of the Engineering Department of Columbia University, and past president of the Institute of Radio Engineers, is his "Elements of Radio Communication." We regard this as the best elementary book to inform you authoritatively on the technical phases of radio in plain language, provided you have some foundation knowledge of radio. The book is a complete course on the elements of radio, containing much material never before published. It has 226 pages, 170 illustrations and a complete index. Cloth bound. Order Cat. MP.



By the same author: "Principles of Radio Communication," second edition. This book is for advanced students. It is the standard of excellence in its field. Cloth bound. Order Cat. MP.

## "Radio Receiving Tubes"

The need for an up-to-date book on radio tubes that answers all the important questions has been filled by James A. Moyer, Director of University Extension, Massachusetts Department of Education, and John F. Westrel, instructor in radio engineering, Division of University Extension, Massachusetts Department of Education. This book is a complete discussion of tube principles, functions and uses. The essential principles underlying the operation of vacuum tubes are explained in a non-technical manner as is consistent with accuracy. The book covers the construction, action, reactivation testing and use of vacuum tubes as well as specifications for vacuum tubes and applications for distant control of industrial processes and precision measurements. 297 pages, cloth bound. Order Cat. MWT.

By the same authors: "Practical Radio" including the testing of radio receiving sets, 378 pages, 223 illustrations. Cloth bound. Order Cat. MVR.

"Practical Radio Construction and Repairing," 319 pages, a companion volume, new second edition. Order Cat. MWPRC.

(NOTE: The standard book on tubes for advanced students is "The Thermionic Vacuum Tube," by Hendrik Van der Bijl. Order Cat. YDB.)

RADIO WORLD, the first and only national radio weekly, eighth year, publishes all the latest circuits and news of radio. Its technical presentations are highly authoritative. Construction of ultra-sensitive and selective circuits is featured regularly. Subscribe for RADIO WORLD and follow the developments on pentodes, Loftin-White amplifiers, band pass filters, pre-tuners, Superheterodynes, screen grid tubes, push-pull, etc.

Radio World, 145 West 45th Street, New York, N. Y. (Just East of Broadway.—Phone BRyant 0558.)

Enclosed please find \$..... for which please enter my subscription for RADIO WORLD for specified period and send free (postpaid) the one premium book designated by my cross in square.

<input type="checkbox"/> REL	\$1.00 for 8 weeks (8 issues)	<input type="checkbox"/> TTU
<input type="checkbox"/> ABSH	\$2.00 for 16 weeks (16 issues)	<input type="checkbox"/> ME
<input type="checkbox"/> FOR	\$3.00 for 6 months (26 issues)	<input type="checkbox"/> PRK
<input type="checkbox"/> MOR	\$4.00 for 34 weeks (34 issues)	<input type="checkbox"/> RTT
<input type="checkbox"/> MWT	\$5.00 for 42 weeks (42 issues)	
<input type="checkbox"/> MWPRC	\$6.00 for 1 year (52 issues)	
<input type="checkbox"/> APAM	<input type="checkbox"/> TSM	<input type="checkbox"/> ME
<input type="checkbox"/> TEL	<input type="checkbox"/> REX	<input type="checkbox"/> PRK
<input type="checkbox"/> RFM	\$7.00 for 60 weeks (60 issues)	
<input type="checkbox"/> VDB	\$10.00 for 86 weeks (86 issues)	
	\$12.00 for 2 years (104 issues)	
<input type="checkbox"/> MAN	<input type="checkbox"/> DRA	<input type="checkbox"/> RTT

Name.....

Address.....

City.....State.....



## Eliminating the Hum

(Continued from page 957)

signal output circuit, and secondly to prevent the signal voltage drop across it from introducing degenerative effects in the grid circuit of the tube. Condenser C2 is the normal combined filter and filter by-pass condenser. So far this is a normal and well-known circuit. If a strong ripple component is present across the B current input—that is, across C2—this ripple voltage will drive a corresponding ripple current through the tube superimposed on the d.c. current driven through it by the d.c. voltage. This a.c. current component will develop a corresponding voltage across the secondary of the output transformer, which will ultimately appear in the following reproducer as a loud hum. If the tube be used for radio-frequency amplification the carrier will be modulated and, after detection and amplification, the hum will likewise appear.

If now condenser C1 and resistance R1 be connected and properly adjusted, the hum will completely disappear without harming the normal signal amplification of this amplifier stage; as a matter of fact it will actually be improved, because the plate circuit signal current will have another path from output transformer B+ to the tube filament, in parallel with that already provided through C2 in series with C and R in parallel. Furthermore, the signal thus by-passed through C1 R1 cannot cause a degenerative effect because it does not flow through R and C, as does that portion flowing through C2. The action of this circuit is as follows: a path for the a.c. component only of the B current is provided across B+ B— through C1 and R1, and thence through C and R in parallel. Since C and R are included in the grid circuit of the tube, the a.c. ripple thus developed will produce a ripple voltage of a magnitude, phase and wave form determined by C1, R1, R.C. and the corresponding characteristics of the ripple voltage across B+ B—. When C1, R1, R and C are properly chosen, the neutralization is of a very high order. It will be seen that the effect of C1 and R1 is to introduce into the grid circuit of the tube a ripple voltage of the same wave form but of opposite phase, and having an amplitude less than that of the plate ripple voltage by a factor equal to the amplification factor of the tube. Both grid and plate, therefore, have the alternating ripple voltages applied, but these are neutralized at every instant, so that no a.c. current can flow through the tube because of them, and only the direct component of the grid and plate voltages remains effective to permit current to flow. Since the signal input voltage is applied to the grid alone, it can and does produce a corresponding alternating signal current component in the plate circuit which appears in the output for further amplification, speaker operation or any other desired function.

Some curves showing the performance of this arrangement may be of interest. The data for them were obtained with the circuit arrangement shown in Fig. 8.

A -80 full-wave rectifier tube is

shown normally energized by a power transformer. It operates into a single-stage filter consisting of a one-half microfarad condenser C1, a choke coil L, having an impedance of 23,600 ohms at 120 cycles and 31 milliamperes of d.c. current, followed by a one-microfarad condenser.

A d.c. milliammeter is included in the filter line to the load, which consists of the load resistance R and the -71 power tube shown. The load current was 31 milliamperes. A d.c. voltmeter across the load resistance indicated the d.c. voltage, which was 220 volts. The -71 tube has no signal input, but was provided with a proper output transformer connected to a Western Electric 540-AW speaker, and a vacuum tube voltmeter as shown. The grid bias resistance was 2,250 ohms, and its bypass condenser C3 was one microfarad. An adjustable mid-point potentiometer was included and carefully adjusted for minimum hum. The hum feedback condenser C+ and resistance R2 were both variable.

In Fig. 9 I show in the curve marked "Hum," with ordinates at the left in volts, the variation of hum output with simultaneous variation of the hum feedback elements C4 and R2. Variation of R2 is indicated in the curve labeled R2, whose ordinate scale in ohms is at the right. The abscissæ scale is in microfarads for capacity of the variable condenser C4. For any given point on the hum curve, the capacity of C4 is given by the abscissæ corresponding to the ordinate of this point. The resistance value for this hum point is obtained from the intersection of the ordinate with the resistance curve. Thus, for 3/10 microfarad and 2,000 ohms the hum voltage is .16 volts or 160 millivolts. The unneutralized hum—that is, the hum with C4 qualling zero—is 600 millivolts, while the least hum, obtained with 1/2 microfarad and 1,900 ohms, was only 10 millivolts. This residual hum was caused almost altogether by the a.c. filament excitation of the tube.

In Fig. 10 I show in the curve labeled R2 the hum variation with variation of R2 alone, C4 being fixed at one-half microfarad; in the curve labeled C4 I show the variation of hum with variation of C4, the resistance being fixed at 1,900 ohms. The abscissæ of curve C4 indicate tenths of a microfarad, whereas for R2 they indicate thousands of ohms. These two curves show the resistance and condenser tolerances with the neutralizing factor here indicated, which is about 60.

This circuit may be used with equal advantage in audio or radio-frequency amplifier tube circuits. I have obtained with some forms of it neutralizing factors as high as ten thousand. That is to say, an output hum of about 50 volts, that is 50,000 millivolts, could be reduced to one of about 5 millivolts when the circuit constants were carefully adjusted. I have developed many variations of the hum-eliminating methods heretofore described, and also many other methods, the presentation of which must be reserved for some future time.



**Also Ejects Static Charges  
Improving Reception**



The Corwico Vulcan Lightning Arrester is manufactured in accordance with a new engineering principle that protects your radio against damage from lightning and also dissipates accumulated static charges. Buy one today for lightning protection and better reception.

At Your Dealer's or Direct  
Upon Receipt of Price.

**CORNISH WIRE CO.**  
24 Church St. New York City

MAKERS OF THE FAMOUS  
**CORWICO**  
**BRAIDITE HOOK-UP WIRE**



Pat. Applied for      Serial No. 375,581

## The Aerial of Tomorrow

Just as the rising sun is the dawning of a new day, the WELLSTON GOLD TEST AERIAL is the beginning of improved radio reception.

Wellston Gold Test Aerial, the wonder aerial of tomorrow, was built to take the place of all present aerials; and it has more than accomplished its purpose.

**Wellston Gold Test Aerial** has a capacity equivalent to 54 feet of aerial wire, 50 feet in the air, and contains gold-plated wire. This little wonder filtered aerial will improve radio reception on most sets, as it helps to eliminate many noises that are troublesome to radio enthusiasts.

This small compact aerial (being but 2 1/2 by 5 inches in size) is small enough to be placed anywhere. It is absolutely non-directional, non-corrosive, will not wear out, and never needs to be replaced. Does not connect into a light socket, therefore there is no AC hum or noise. The Wellston Gold Test Aerial eliminates all lightning hazards. Not fully efficient on battery sets.

For Sale by All Leading  
Radio Dealers Everywhere

**Price, \$2.50**

**Wellston Radio Corpn.**  
Dept. R.N.,      St. Louis, Mo.



# EXCELLO RADIO



STYLE NO. 154

Genuine Screen Grid radio with dynamic speaker and high grade cabinets for radio or radio-phonograph combinations.

Write today for free illustrated catalog of Radio and Radio Cabinets

**EXCELLO PRODUCTS CORPORATION**  
4832 West 16th Street  
CICERO, ILLINOIS

## EXPLORE THE SHORT WAVES WITH THE EXPLORER PLUGLESS CONVERTER \$12.50

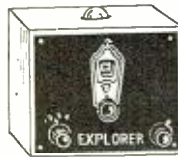

No PLUG-IN COILS! Wave length range 15 to 200 meters; CHANGES WAVE LENGTH BANDS BY THE TURN OF A KNOB. The EXPLORER enables you to explore the wonders of modern short wave reception with your broadcast receiver. Stations all

over the world are at your disposal on the short waves. The EXPLORER is a 1930 model, efficient and scientifically improved converter. Beautiful appearance; illuminated vernier dial; shielded; tube inserts inside of cabinet; and absence of plug-in coils make it the most convenient of all converters.

Best performance at the lowest price. GUARANTEED. SOLD DIRECT FROM FACTORY. ORDER NOW! A. C. or D. C. model only \$12.50. Sent postpaid upon receipt of price or C. O. D. plus postage upon receipt of \$1. State whether A. C. or D. C. model is desired. SEND FOR FREE LITERATURE.

**Rim Radio Mfg. Co.**

695 Grand St. BROOKLYN, N. Y.

## MASON, FENWICK & LAWRENCE PATENT LAWYERS

600 F St., N. W., Washington, D. C.

Estb. over sixty years. Send sketches. Electrical, Aeronautical and Chemical Inventions carefully handled. Practice before the U. S. Courts and the Patent Office. Prompt and careful service. Write us. Protect your inventions.

TRADE MARKS REGISTERED

Write for Information About the NEW

## H-F-L MASTERTONE

Laboratory-Made Receiver

The year's outstanding Radio Achievement

HIGH FREQUENCY LABORATORIES  
28 N. Sheldon St., Dept. 26, Chicago, Ill.

## A Universal Auto-Radio Receiver

(Continued from page 924)

frame. The majority seem to have the negative terminal grounded; yet there are so many in which the opposite pole is used that another problem is presented in the design of a radio outfit applicable to any machine. At first thought, it might appear to be a simple detail, but, on going over the circuit to be used, we see that it would be much easier to assemble and wire the receiver if grounding one side of the filament supply system were permissible. One side of the tube sockets, filament resistances, A, B, and C batteries and some grid return leads might all be connected to the frame with the shortest conductor possible to use. It would not only save material and time, but also contribute toward improving the appearance of the set and simplifying its circuits. But since it cannot be done conveniently there is little use in visualizing the advantages. We say "conveniently" as a qualification to cover the possibility of building a set with one side of the filament circuit grounded, and with the terminals marked "grounded" and "ungrounded" rather than "positive" and "negative." The only difference caused by a change in the storage battery polarity would be to affect the grid bias on whatever filament tubes were used. Cathode tubes would have their cathodes grounded for simplicity, and thus the ground connection would become the common terminal of the negative side of the B battery and the positive side of the C. By this system, tubes not of the uni-potential cathode type would show a grid bias equal to the drop across their filament, if a change in A battery polarity were made. But the best reason for not adopting such circuit arrangements is that we would have to depend upon an external C battery for the several voltages desired, with the consequent requirement of a number of leads running from the set to taps on the battery. Representing for the most part one side of tuned radio-frequency circuits, they would have to be equipped with choke coils and condensers to keep the high-frequency currents from flowing in them and causing undesired coupling effects. An alternative would be to use a tapped C battery resistance in the receiver case. The objections to this are that a separate resistance would have to be used for each radio-frequency stage to keep down the number of conductors running from one compartment to the other, a by-pass condenser would be required to shunt each resistance, and a switch, in addition to the A battery switch, would be required to keep these resistances from running down the C battery.

This makes it appear that we should forget the grounding matter, and go ahead and wire our set as we used to in the days of one hundred per cent. non-conducting panels and cabinets. But, unfortunately, we cannot discard the problem so easily. This is because one side of practically all modern variable condensers is connected to the metallic frame by which they are mounted, thus definitely grounding the corresponding side of each circuit that includes a unit of the tuning condenser.

(Continued on page 961)

# .. Was the Life of the Party!

I FRANKLY admit that until recently I was about the most awkward blushing wallflower who ever dared to go to a party.

But my life has certainly changed. Instead of overhearing myself referred to as an "old oil can," it seems now as though the fellows and girls can't pay enough attention to me. Now every time the gang throw a party they insist that I come.

Don't think I'm bragging. I remember all too keenly what it felt like to be a lonesome dud in the midst of a lively crowd. And I'm so thankful to a certain Prof. Dunninger for my new found popularity that I am only too glad to give the credit where it belongs.

Some time ago I read an ad just as you're doing now about Dunninger's famous book—"POPULAR MAGIC AND CARD TRICKS." As it cost only 50c with "money-back-if-not-satisfied" guarantee, I thought I'd try it.

I received the book by return mail and was amazed to see how easy it was to do magician's tricks. In short order I became expert in performing a dozen or more mysterious stunts that astounded everyone, myself most of all.

At the next party I went to I gave a one-man show that simply overwhelmed the whole gang. For an hour or more I made cards fly, glass bowls disappear, coins vanish, performed secret mind reading—in short, held my audience dumbfounded and completely mystified!

You, too, can entertain and astound your friends—win greater popularity—experience countless evenings of enjoyment with the more than 200 magic tricks this book explains in simple English and easy to understand pictures.

Never before have you had a chance to get so much real pleasure and value for only 50c. While we still have a few hundred books left—

**Clip  
and Mail  
Coupon  
TODAY!**



EXPERIMENTER PUBLICATIONS, Inc.,  
Dept. 2404-Y, 381 Fourth Ave.,  
New York, N. Y.

I enclose 50c (in stamps, coin or money-order) in full payment for Prof. Dunninger's famous big 100-page book—"POPULAR MAGIC AND CARD TRICKS"—which it is understood will be shipped to me by return mail.

Name .....

Address .....

City and State .....

I enclose 50c additional for which also send me the big complete illustrated book I have checked below:

- How To Win at Bridge
- Flying for Everybody
- New Radio Trouble Finder



**NEW**  
**BISMARCK HOTEL**

RANDOLPH AT LA SALLE  
YOUR VISIT TO CHICAGO

Will be a pleasant memory if you select the right hotel. The New Bismarck welcomes you to a hostelry where good food, superior service and cheerful comfort await you. Easily accessible to all the high spots of the city.

Rooms \$2.50 up.  
With Bath \$3.50 up.



**BANKRUPT RADIO STOCK**

Fully Guaranteed

ABC Power Packs, 250 V. of B. Also has A. C. filament for up to 9 tube sets. Can be used as B eliminator. Make your battery set all electric or build your new A. C. set around this pack. Completely assembled ..... \$ 8.75  
7 Tube A. C. Sets ..... 24.50  
Short Wave Sets, one tube, complete with 5 coils, 30 to 550 meters ..... 6.45  
12 Mfd. Condenser Blocks, 1000 volts ..... 4.75  
A. C. 600 V. Power, Filament & Double Choke Pack ..... 5.00  
For one 281, one 250, one 227 and four 226 tubes  
Tubes 1X type (Guaranteed No. 210, \$2.25; No. 250, \$2.35; No. 281, \$1.85; No. 280, 95c; No. 245, \$1.25; No. 224, \$1.65; No. 227, 75c; No. 226, 65c; No. 171, 75c; No. 199, 95c.

**CHAS. HOODWIN CO.**

4240 Lincoln Ave., Dept. D-3, Chicago, Ill.

Dealers in Bankrupt Radio Stocks

**TRUSS USERS**

Learn how to close the rupture opening, so the rupture can't come down. Get a Ten Day Test of the herbal muscle- tonic "Plapao", and 48 page illustrated book describing the effective home treatment used by satisfied thousands without delay from work. Awarded Gold Medal, Rome, Grand Prix, Paris, and other proofs of merit. You can make this test which started many others on the road to better health without cost—FREE. Write TODAY to Plapao Co., 375 Stuart Building, Saint Louis, Missouri.

**WANTED — MEN**  
TO MANUFACTURE METAL TOYS AND NOVELTIES

Big demand for 5 and 10c store Novelties, Ashtrays, Toy Soldiers, Animals, Auto Radiator Ornaments, etc. We co-operate in selling goods you make; also buy these from you. Small investment needed to start and we help you build up. WE FURNISH COMPLETE OUTFITS and start you in well-paying business. Absolutely NO EXPERIENCE and no special place needed. A chance of a lifetime for men with small capital. Write AT ONCE if you mean strictly business and want to handle wholesale orders now being placed.  
**METAL CAST PRODUCTS COMPANY.**  
Dept. 12, 1696 Boston Road - - - New York City

(Continued from page 960)

A fine predicament: a vacuum-tube circuit, Fig. 1, whose grid return is at ground potential, where either side of the filament may be grounded, and with the requirement of a definite grid bias to be obtained from the A b battery, regardless of the polarity of its ground! Our first impulse is to insulate the condenser frame from the metal case, but what of the shaft that may touch the frame of the car a dozen times before reaching the remotely located dial? The answer to that might logically be an insulated bushing.

**Circuit Details**

The circuit shown in Fig. 2 is a more practical solution. Allow one side of the variable condenser to maintain its ground potential, connect its associate inductance to it in the usual manner at the grid end, but, instead of directly attaching the opposite terminal, wire that to the condenser through a .25 mfd. or larger fixed condenser. Also connect this lower end of the coil to a point in the filament circuit, which differs from the point at which the cathode is wired, by a potential equal to the grid bias desired. Obviously with such a circuit the polarity of the storage battery ground is immaterial. At a glance, one might say that this condenser would affect the tuning of the circuit, since it is in series with the variable capacity. But by applying the common formula for series condensers, it will be found that the decrease in capacity, caused by the .25 mfd. fixed condenser, amounts to only about a tenth of one per cent. where a .00035 mfd. variable is used.

Electrical interference, caused by the ignition of the car, is something that must come in for a good share of attention. This system that fires the gas in the engine cylinder is nothing but an untuned spark transmitter, as far as our radio receiver is concerned, and, therefore, a source of powerful interference on all wavelengths. About the only fields now open for the broad spark transmitters are those for ignition and distress signals, but following their gradual decline, which started in 1912, we may reasonably expect some future Department of Commerce ruling to restrict the radiation from internal combustion engine electrical systems. In the meantime, the radio motorist can prepare to shield his electrical wiring, spark plugs, coils, magneto and the like while day-dreaming of a machine powered with a Diesel motor. Since so much has already appeared in RADIO NEWS on the various methods of eliminating ignition interferences, we will not consider the matter in detail in this article.

Antennæ, loud speakers and controls for the automobile radio set are other relevant subjects which will be taken up as soon as we present the construction of the set proper.

Having worked out the many problems in more detail than space permits us to mention, let us refer to the complete circuit which is our answer to the various demands. This is shown in Fig. 3.

At the input end, we find the antenna connected directly to the grid of the first screen-grid tube, with no means of tuning

(Continued on page 963)

**Amazing Reception!**  
**"Super Ball" Antenna**

Thousands of users are getting marvelous reception with the SUPER BALL ANTENNA the "all directional" aerial, which brings out the hidden powers of all A. C. radio sets.



SUPER BALL ANTENNA features a patented condenser which acts as a neutralizer for the entire system and greatly clarifies tone.

SUPER BALL ANTENNA gives greater selectivity, volume and distance due to its conductive surface of 364 sq. inches.

SUPER BALL ANTENNA is easily installed in a few minutes and gives a lifetime of satisfaction.

Over 1,000,000 in Use

Super Ball with Condenser \$475 Complete Kit for Installation \$350

Get one today at your radio dealer. Write for our folder, "How the SUPER BALL ANTENNA works."

**YARR-LANGE INC.**

205 E. Water St. Milwaukee Wis.

**The Radio Construction Library**

[Latest Data on Radio Receivers] for the Dealer, Serviceman and Amateur

WRITTEN by two widely known radio engineers, these three books cover every phase of building, repairing and "trouble-shooting" on modern receiving sets. This practical library includes: PRACTICAL RADIO—The fundamental principles of radio, presented in an understandable manner. Illustrated with working diagrams. PRACTICAL RADIO CONSTRUCTION AND REPAIR—Methods of locating trouble and reception faults and making workmanlike repairs. RADIO RECEIVING TUBES—Principles underlying the operation of all vacuum tubes and their use in reception, remote control and precision measurements.

Three Volumes, 6 x 9—993 pages, 561 illustrations.

See this Library FREE!

No Money Down



**McGraw-Hill**

**FREE EXAMINATION COUPON**

McGraw-Hill Book Company, Inc. 370 Seventh Avenue, New York

Send me the new RADIO CONSTRUCTION LIBRARY, three volumes, for 10 days' free examination. If satisfactory I will send \$1.50 in ten days, and \$2.00 a month until \$7.50 has been paid. If not wanted I will return the books.

Name .....  
Home Address .....  
City and State .....  
Position .....  
Name of Company ..... R. N. 4-30



# WARNING

## RADIO NEWS

### Subscription Price

# GOING UP!

# LAST CHANCE

**to subscribe—or have your present subscription continued from expiration—at these Special “LAST CHANCE” low rates!**

<b>One Full Year—Only</b>	<b>\$2.00</b>	<b>You Save</b>	<b>\$1.00</b>
<b>Two Full Years—Only</b>	<b>3.00</b>	<b>You Save</b>	<b>3.00</b>
<b>Three Full Years—Only</b>	<b>4.00</b>	<b>You Save</b>	<b>5.00</b>

**Offer Open Only Until April 10th**

Savings Figured on Newsstand Prices

The subscription price of RADIO NEWS will be increased to \$3.00 a year, effective with the next (May) issue!

It would be decidedly unfair to put this increase in effect without giving all our old friends an opportunity to protect themselves for 1, 2, or 3 years ahead at the old low rate.

We are doing even more! For just one month (until April 10th only) we are allowing all present subscribers and newsstand readers to order subscriptions to RADIO NEWS at extraordinary “LAST CHANCE” rates which have been reduced even lower than the old low rates!

Here’s your “LAST CHANCE” to save from \$1.00 to as high as \$5.00 on the leader of all Radio Magazines. And you make this unprecedented saving just when the NEW RADIO NEWS is giving greater value than ever before!

As you can see from this issue, RADIO NEWS tells you all about the newest receivers, all about the latest dis-

coveries in servicing and handling radio parts and sets—and then goes beyond all that to give you the vital radio news of the whole world in a terse way that demands reading by every man whose interest lies in radio.

If the Federal Radio Commission makes a new ruling—if an Austrian inventor designs an improved tube—if a new discovery in television occurs in Greece or even Patagonia, you’ll find it all described and its practical significance explained in RADIO NEWS.

... That is why RADIO NEWS is read by men who want to see with modern vision the *future* trends and developments of radio’s rapid progress.

... That is why it has practically twice as many readers the world over as any other radio magazine.

... That is why you *need* RADIO NEWS and will want to take advantage of these tremendous “LAST CHANCE” savings immediately!

**LAST CHANCE Ends April 10th**

**Mail Coupon NOW!**

RADIO NEWS, Dept. 2404,  
MACKINNON-FLY PUBLICATIONS,  
381 Fourth Avenue, New York, N. Y.

Gentlemen: YES, please enter my subscription to RADIO NEWS at the extraordinary reduced “LAST CHANCE” prices for the number of years checked below. Remittance is enclosed.

One Year at \$2.  Two Years at \$3.  Three Years at \$4.

Name .....

Address .....

City and State .....

*Present subscriptions will be continued from date of expiration.*

To Save \$1.00 to \$5.00 on

# RADIO NEWS

Clip and Mail TODAY →



## A Universal Auto-Radio Receiver

(Continued from page 961)

the circuit. A 2 megohm resistance runs from the grid to the negative side of the heater, so as to utilize the drop across the heater, giving the control element a negative charge. The cathode is wired to the positive side of the filament, and thence to the ground to complete the energy-absorbing system. A tuned circuit would, of course, increase the efficiency of this first stage, but, due to the uncertain characteristics of the aerial, a separately controlled condenser would be required to keep the circuit in resonance with those of the other radio-frequency amplifiers. If, to eliminate the extra control, a fourth condenser, used for this input circuit, were mounted on the shaft carrying the other three, it would be extremely difficult, if not impossible, to compensate for the effect of the antenna over the wavelength range to be covered. Consequently, tuning of the first stage was avoided for the sake of simple adjustment and operation.

The next three tubes have tuned grid circuits adjusted by .00035 condensers mounted on a common shaft. With all coils and condensers alike, mounted symmetrically, and spaced equidistant from adjacent parts, there is no difficulty in keeping the circuits in synchronism.

The filaments are arranged in a series—parallel formation, two branches consisting of two type -24 tube heaters, and a 1 1/4-ohm resistance in series, while the third comprises a series hook-up of a 4-ohm resistance and the filament of the -12A power tube. When the A supply is at 6 volts, the tubes then receive less than their rated potential, but by reference to Fig. 4 it will be seen that but little efficiency is sacrificed. At the maximum of 7 1/2 volts (which a fully charged battery will attain while on charge), the tubes are but slightly overloaded.

With the voltage of the car's battery

subdivided by the series connections, it is a simple matter to obtain approximately correct grid voltages for all tubes but the power tube. For this we use an external C battery. All screen grids are by-passed to ground by .5 mid. condensers, and are connected to the B battery through individual radio-frequency chokes. The detector screen-grid supply lead is attached to the 67 1/2 B battery tap, while the radio amplifier screen leads are grouped together and pass through a variable resistance on the control panel. This is a volume regulator whose other side is connected to one of the higher taps on the B battery, the exact contact being determined by experiment. In a.c.-operated radio outfits it is customary to employ a potentiometer rather than a series resistance for the volume control. But to do so here would necessitate the use of an additional switch to break the potentiometer circuit when the set is out of use. Otherwise, a heavy drain on the B battery, with consequent short life, would result.

The A battery switch is not included in to set proper, but is to be mounted on the control panel with the tuning dial and volume control. While fuses are always good insurance against damage by shorts, we believe it best to locate such protecting devices nearer to the battery than to the set. It is our opinion that there is less danger of short circuits in the set itself than in the leads coming from the battery, especially where these wires are connected to the instrument. Fuses on the set would, therefore, give only a part of their possible protection.

This brief consideration of the circuit serves to give us a fair idea of the set we are to build. As we proceed with its construction we will go into details that should interest anyone who enjoys the science of radio receiver design.

## The Auditorium Power Amplifier

(Continued from page 931)

The first experimental amplifier was made using a -24 tube as a voltage amplifier, feeding a -50 type power tube. The final curve, using a very good output transformer, is shown at C. For the sake of ready comparison this curve has been moved up so that the amplification at 1,000 cycles is approximately 66 d.b. Actually, the amplification is considerably less than that given for curve D, but the differences in amplification at various frequencies expressed on the d.b. scale are accurate. These show that the amplifier is down 70% at 10,000 cycles. Part of the loss at both the low- and high-frequency end is due to the output transformer, a characteristic of which is shown in curve C of Fig. 2. Regardless of the type of voltage amplifier used ahead of the power stage some type of output transformer must be used. The curves shown in Fig. 3 show typical designs and indicate the compromise which must be made between high- and low-frequency response. Curve B, for example, has excellent transmission at the low end but suffers at the high end due to the increased distributed capacity of the higher

inductance winding. Curve D has good highs but falls off a bit on the lows. Curve C shows the final transformer which has a very good core permitting the necessary inductance to be obtained with a minimum number of turns. For the sake of comparison the curve of the -24 tube with a .5 megohm coupling resistance operating directly into a -50 type tube is given at A. The additional loss at the low end (i. e., more than shown at C Fig. 3) is due to common coupling impedance in the bias circuits. The additional loss at the high-frequency end is due to the capacity loading effect of the -50 tube on the coupling resistor.

An attempt was first made to increase the low-frequency amplification at resonance enough to keep the curves absolutely flat down to 40 cycles. The curve of this transformer is shown at A in Fig. 3. Although the bass response was very satisfactory, it will be noted the highs fell off appreciably due to the high primary and secondary inductances which were required with a consequent high secondary distributed capacity.

(Continued on page 964)

## Build Your Own Voltage Multiplier

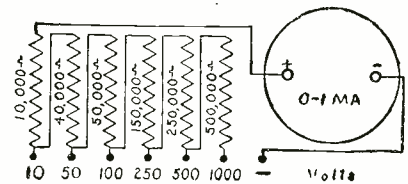

The Super Akra-Ohm wire-wound Resistor is especially adapted for use as a Voltage Multiplier as shown in the above diagram. It is carefully designed to insure an accuracy of 1 per cent and a constant permanency of calibration. Its use is also highly recommended for Laboratory Standards, High Voltage Regulators, Telephone Equipment, and Television Amplifiers, Grid and Plate Resistors, etc.



500- 80,000 ohms...	\$1.50
90,000-150,000 ohms...	2.00
175,000-250,000 ohms...	2.50
300,000-500,000 ohms...	3.00

**SHUNTS** for increasing the range of milliammeters, \$3.00 each. Let us know your requirements. Specify make, model and range of instrument.

### ASK FOR BULLETIN 62-D

containing voltage multiplier data for the use of Super Akra-Ohm Resistors with milliammeters.



A Sure Way of Passing your Government Examinations!

Here are all the questions — completely answered

## How to Pass U. S. Government Radio License Examinations

By R. L. Duncan and C. E. Drew  
R. C. A. Institutes, Inc.

Don't take any chances with your examinations. Careful study of this book will insure success in obtaining your government radio license, because it contains full particulars, questions and answers, on the latest radio examinations by the government.

It will not only give you all the data, but through the question-and-answer method used in the text, will teach you how best to express yourself and put that knowledge into words.

259 questions with complete answers show you just what will be expected of you.

Order a copy now—and start studying!

\$2.00

ON APPROVAL COUPON

JOHN WILEY AND SONS, Inc.  
440 Fourth Ave., New York

Gentlemen: Kindly send me on approval Duncan and Drew's "How to Pass." At the expiration of ten days I agree to remit \$2.00 or return the book, postpaid.

Name .....

Address .....

Reference .....

R.N.4-30



### BE a FOOT SPECIALIST!



**EARN MORE MONEY**  
Learn PEDOPRACTIC—the new system of correcting foot disorders and deformities without medicine or surgery that's making tremendous strides these days. It's a new uncrowded profession and offers amazing opportunities in an unlimited field. Dignified, interesting and profitable. No thinking man or woman will willingly neglect foot troubles when they produce so much discomfort and disability and can be so easily corrected.

**LEARN QUICKLY AT HOME IN SPARE TIME!**  
With but ordinary education and leisure home study you can quickly qualify for this profession with its social, professional and financial advantages.

**EARN WHILE YOU LEARN**

The demand for your services will be so great that you can start in your own home and earn the cost of your training while you are studying the course. We teach you how to quickly "cash in" on your knowledge.

You can quickly build up a practice and have an office of your own. It's a wonderful opportunity, so act quickly. Clip coupon below, sign name and address, mail today for full information about this wonderful new science. Do it now. No obligation.

— CUT HERE —

**AMERICAN COLLEGE**  
Chartered 1915 by the State of Illinois  
Dept. P-4 54 W. Illinois St., Chicago

Name .....

Street .....

Town ..... State.....

### RADIO OPERATORS WANTED



Radio operators are officers aboard ships. Well paid, pleasant work, travel. You can qualify in a short time in our well-equipped school under expert instructors.

Write now for free booklet on "Opportunities in Radio."

**West Side YMCA**  
Radio Institute  
319 West 57th St., New York, N. Y.



### High School Course in 2 Years

This simplified, complete High School Course—specially prepared for home study by leading professors—meets all requirements for entrance to college, business, and leading professions.

**20 Other Courses**

Over 200 noted Engineers, Business Men, and Educators helped prepare the special instruction which you need for success. No matter what your inclinations may be, you can't hope to succeed without specialized training. Let us give you the practical training you need.

**American School**  
Drexel Ave. & 58th Street  
Dept. H-453, Chicago

**Money Back When You Finish If Not Satisfied**

**AMERICAN SCHOOL, H-453**  
Drexel Avenue and 58th St., Chicago

Send me full information on the subject checked and how you will help me win success in that line.

.... Architect	.... Electrical Engineer
.... Building Contractor	.... General Education
.... Automobile Engineer	.... Lawyer
.... Civil Engineer	.... Mach. Shop Practice
.... Structural Engineer	.... Mechanical Engineer
.... Business Manager	.... Steam Engineer
.... C. P. A. Auditor	.... Draftsman & Designer
.... Bookkeeper	.... High School Graduate

Name..... Age.....

St. and No.....

Town..... State.....

(Continued from page 963)

Due to the fact that at the low frequencies the minimum perceptible difference is several d.b. it was considered very much better to maintain the high-frequency response which is important, even at a slight sacrifice of the lows.

The transformer which resulted is shown at curve B, Fig. 3. Curve C shows the low-frequency amplification of the same transformer without the primary resonating circuit. By using the combination of primary resonance to get high amplification at the low frequencies and a special coil and care design (which gave a very low value of leakage reactance and distributed capacity with a consequent peak at 9,000 cycles) the loss in the rest of the amplifier at both the low and high frequencies was largely compensated for.

Due to the large undistorted output which the -45 tube is capable of giving, there is ample to swing the 250 tube grids. Just as satisfactory results are obtained by using this tube as can be secured by using a pair of smaller tubes in push-pull.

The resulting amplifier is very stable. Curve B, Fig. 1 shows the excellent high-frequency reproduction that was obtained in one of the earlier experimental models, but this was abandoned in favor of curve A because the frequencies above the audible limit are not necessary and may cause trouble, since with the very high amplification obtained, only a small amount of capacity coupling between the input and the output at these frequencies will result in a sustained oscillation at a frequency above audibility.

Of special interest is the high overall amplification which was finally secured; viz., 72 d.b. This gain, which represents a voltage amplification of 4,000, means that there is sufficient to operate directly out of a low impedance pick-up, for example, without any impedance adjusting transformer. There is also sufficient output so that the amplifier can be used in experimental work with photo-electric cells having a high output. Where the maximum possible amplification is wanted, it may be secured by using an impedance-adjusting transformer to work out of a low impedance source into the 100,000-ohm input potentiometer.

When using an input transformer such as the SM 255M, a total voltage amplification of 63,200 corresponding to a gain of 95.8 d.b. may be secured from a double microphone which is sufficient for most "distant" pickup work. Where experimental work with extremely small inputs is to be done, when working out of a photo-electric cell for example, which gives a very limited output, only a single -12A tube need be used as a pre-amplifier. If the photo-electric cell is resistance-coupled to a -12A tube and this in turn coupled through a 2 1/4 or 2 1/2 to 1 ratio transformer to the 692, a total voltage amplification of 46,000 is available.

Due to the use of a potentiometer input, this may be used as a volume control without affecting the frequency characteristic. In the conventional type of amplifier the volume control must either

# How Would You Like a \$15<sup>00</sup> Check?

... and Cash Commissions of Four Times that Amount?

From boys and girls in their teens to grandmas and granddads, hundreds of folks are turning their leisure moments into good hard cash—without experience and without interfering with their regular duties.

You, too, can have an extra independent income in addition to your regular source of funds. We supply everything you need free. Just as hundreds of others are doing—you can make extra cash roll into your pockets by simply taking care of new and renewal orders for the 12 famous MACKINNON-FLY PUBLICATIONS — the magazines that sell themselves!

Your spare time is worth money—don't waste it. Mail coupon TODAY!

\$-----\$

MACKINNON-FLY PUBLICATIONS, INC.  
Dept. 2404-W, 381 Fourth Ave.  
New York, N. Y.

Without obligation to me, please tell me how I can easily earn BIG MONEY in my spare time.

Name.....

Street.....

City..... State.....

(Continued on page 965)



(Continued from page 964)

be of the "T" or special network type which is very expensive or, if it is of the straight potentiometer type, it will introduce both wave form distortion and frequency discrimination. The potentiometer type of input has the further advantage of permitting an external potentiometer to be used with the slider connected to the input of the 692 without introducing either form of distortion. In this case, the input potentiometer of the 692 is set and used as a gain limiting device.

The advantages of working into low-impedance circuits are now generally recognized. The present practice is to use a one-to-one transformer in the output of the amplifier to get out of the tubes into from 3,600 to 7,200 ohms. An external impedance-adjusting transformer has been connected to the amplifier to get into low impedances ranging from 8 to 100 or more ohms. While this arrangement is very much more satisfactory than working through a high impedance circuit, particularly when the output is to be transmitted any distance, it is very much less desirable than operating directly out of a single transformer since the loss, frequency discrimination, wave distortion and cost are all increased by the additional transformer.

### Assemble Your Own Auto-Radio

(Continued from page 896)

condensers. This method enables the operator to log his stations as he does on his set at home. The compound system of gearing, shown in the photograph, comes completely mounted on a metal base plate. It comprises four gears which mesh 1 to 5 and then 1 to 10. These four gears are mounted on three studs, which are in turn mounted on the metal base plate mentioned above. Four long bushings are also mounted on the base plate for the dashboard mounting.

At the receiver end the worm gear is coupled to the flexible shafting by means of a threaded collar and square key, which, incidentally, is the same as the control side. The threaded collar is part of the bearing block for the worm gear. This bearing block gives the worm gear a positive motion. It prevents the slightest deviation from the proper movement of the worm. This last precaution is an absolute necessity because of the accurate motion which a worm must have in order that it operate correctly. The worm gear meshes with a flat ground gear which is mounted on the shaft, which, in turn, couples all the condensers. From the shaft on the condensers to the tuning knob, the operator can be assured of a positive motion, for every possible precaution has been taken into account.

The volume control and filament switch are arranged on a single knob. A four-wire shielded cable is supplied to provide the necessary two leads each for the switch and the volume control. There are therefore only two controls on the dashboard—the main tuning knob and the

(Continued on page 968)

## OWN the World's Premier Custom-Built RADIO

BAND-FILTER

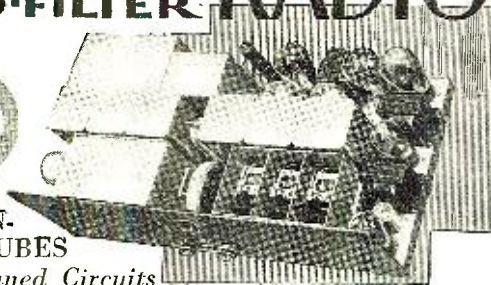

SCREEN-GRID TUBES

Six Tuned Circuits

REGARDLESS of cost, no radio produced in mass can even approximate the amazing performance of the Hammarlund Custom-Built "HIQ-30."

Here is the newest and most efficient model by Hammarlund-Roberts—the climax of five years of unequalled custom designing and famed throughout the world for power, selectivity and tone.

Assemble it yourself from factory-built units or we'll recommend a local custom-builder to do it for you. \$139.50 to \$175, complete, less tubes. Send 25c (stamps or coin) for 48-page "HIQ-30" Manual. Address, Dept. RN-4.

HAMMARLUND-ROBERTS, INC.  
424-438 West 33rd Street, New York, N. Y.

Your Choice of FINEST CABINETS and SPEAKERS

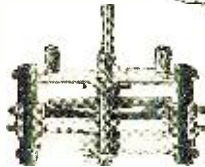

### IN THE AIR OR ON THE AIR CLASS TELLS!

Cardwell Condensers have always been "The Standard of Comparison." Years of superlative performance have earned the title of "The Best." There is a Cardwell for every purpose—Receiving and Transmitting. Write for Literature.

THE ALLEN D. CARDWELL MFG. CORPORATION  
81 PROSPECT STREET + + + BROOKLYN, NEW YORK

### New Adapter for the 245 SUPER POWER TUBE

Bring your present set up-to-date using the New 245 Super Power Tube, regardless of what you now have. No rewiring necessary. This adapter makes the job simpler; anyone can hook it up in a few minutes' time. Greater volume, finer clarity and an amazing ability to reproduce low notes are the features gained through the use of the 245 tube and this adapter. Rewiring of your set is necessary if you do not use this adapter. You simply cannot do without it.

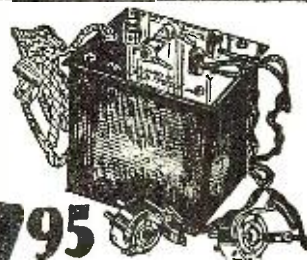

THE RADIO SET HOUSE OF BROOKLYN  
**BROOKLYN RADIO**  
Service Corp.

\$7.95

List Price \$15

1072 ATLANTIC AVE., BROOKLYN, N. Y.

All Orders Must Be Accompanied By a Deposit of 20%

### Home-Study Business Training

Your opportunity will never be bigger than your preparation. Prepare now and reap the rewards of early success. Free 64-Page Book: Tell How. Write NOW for book you want, or mail coupon with your name, present position and address in margin today.

- |  |  |
|--|--|
| <input type="checkbox"/> Higher Accountancy        | <input type="checkbox"/> Business Corres.      |
| <input type="checkbox"/> Mod. Salesmanship         | <input type="checkbox"/> Credit and Collection |
| <input type="checkbox"/> Traffic Management        | <input type="checkbox"/> Correspondence        |
| <input type="checkbox"/> Rail. Station Mgm't       | <input type="checkbox"/> Modern Foremanship    |
| <input type="checkbox"/> Law: Degree of LL.B.      | <input type="checkbox"/> Personnel Mgm't       |
| <input type="checkbox"/> Commercial Law            | <input type="checkbox"/> Expert Bookkeeping    |
| <input type="checkbox"/> Industrial Mgm't          | <input type="checkbox"/> C. P. A. Coaching     |
| <input type="checkbox"/> Banking and Finance       | <input type="checkbox"/> Business English      |
| <input type="checkbox"/> Telegraphy                | <input type="checkbox"/> Commercial Spanish    |
| <input type="checkbox"/> Business Mgm't            | <input type="checkbox"/> Effective Speaking    |
| <input type="checkbox"/> Railway Accounting        | <input type="checkbox"/> Stenotypy—Stenog'y    |
| <input type="checkbox"/> Paper Salesman's Training |  |

LaSalle Extension University, Dept 494-R, Chicago

### A Radio Parts Guide THE NEW YAXLEY Catalog



Send for it today for complete listings of Radio Convenience Outlets, Connector Plugs, Rheostats, Fixed and Grid Resistances, Jacks, Jack Switches, Phone Plugs, etc.

YAXLEY MFG. CO.

Dept. N, 1528 W. Adams St., Chicago, Ill.



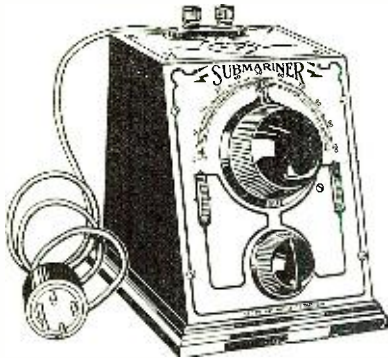

**SHORT WAVES**

**THE SUBMARINER**

will convert your receiver into a short wave receiver without any changes. Enthusiastic owners have written us from all parts of the world. Stations broadcasting music 8000 miles away have been received. Very little static on short waves. Latest improvements—shielded—vernier dial 64 to 1 ratio—a quality product—on the market over three years.

**MANY MODELS**

16-32 meters, AC or DC, \$17.50. Interchangeable coil, 12-160 meters, AC or DC, \$22.50. "J" model gives five times volume of other adapters, price, 16-32 meters, \$22.50. Interchangeable coil "J" model, \$27.50. Sent postpaid upon receipt of price or C. O. D. if \$1.00 accompanies order. Give name of set and tubes used, when ordering.

J-M-P MFG. CO., INC.

3415 Fond du Lac Ave., Milwaukee, Wisconsin

**✓ FREE BOOKS of BUSINESS HELPS**

We publish over 200 Home Study Books, each a complete treatise of its subject. We have one or more for you.

- Books on
- Commercial Art
  - Lettering
  - Advertising
  - Sign Making
  - Radio
  - Aviation
  - Painting
  - Silk Screen Process
  - Decoration
  - Automobiles
  - Battery Work
  - Electricity
  - Carpentry
  - Building
  - Contracting
  - Sheet Metal Work
- and many other subjects. All fully described in our FREE CATALOG. Check the subjects in which you are interested and write today.

**FREDERICK J. DRAKE & CO., Publishers**

Room 510—179 No. Michigan Blvd., Chicago

Drake books are for sale in all book stores



**Cuts Radio Tube Costs**

tubes \$2.50  
tubes \$1.95  
tubes \$3.50

AMPERITE automatically keeps voltages exactly right for tube efficiency. Lengthens tube life. For all tubes. \$1.10 with mounting (in U.S.A.) At all dealers.



**TYPEWRITER 1/2 Price**

World's best makes—Underwood, Remington, Royal—also portables—prices smashed to below half. (Cash terms)

**SEND NO MONEY!**

All late models completely rebuilt and refinished brand new. Guaranteed for ten years. Send no money—big free catalog shows actual machines in full colors. Get our direct-to-you easy payment plan and 10 day free trial offer. Amazing values—send at once.

231 W. Monroe St. Dept. 421, Chicago

**International Typewriter Exch.,**

**PATENT YOUR INVENTIONS**

**EDWARD GOTTLIEB**  
Attorney in Patent Causes  
5 Beekman Street  
New York

Inventions Developed—Representative for Blair Tool and Machine Corp.

**Sunspots, Weather and Radio**

(Continued from page 889)

matters, while solar effects and magnetic storms are world wide. In addition, most weather-radio investigations fail to discount solar and magnetic effects, or indeed to take them into account at all, though they are fully as important as the others. The meteorological elements which can conceivably affect transmission are temperature, pressure and moisture.

We can make some general statements which rest on fair agreement. Austin has found that long-wave day signals vary inversely with temperature—cold waves mean strong signals. Sreenivasan finds substantially the same effect, extending his temperature data to the transmitter as well as the receiver. On the broadcast waves, however, Pickard finds that reception varies directly with temperature at the receiving station—the warmer the night, the better the reception. The universal belief that winter reception is much better than summer reception is perhaps due as much to darkness and lack of absorbing vegetation as to temperature.

Years ago Kincaid on the naval ship *Kittery* found, as have many observers since, that static (or atmospherics) seems to originate in lows. This is particularly true of tropical hurricanes, which are small, violent lows. It is further noticed, as we might expect, that the worst static comes from the southeast quadrant of the low—the rain or snow quadrant in winter and the thunderstorm quadrant in summer. Some of the Florida hurricanes have been followed by direction finders in Maine, a thousand miles distant. Thus in the future radio may be of value in tracking storms. The sun, too, seems to have a finger in the pie, for Pickard has made the interesting observation that night static varies directly with sunspots, while for day static the relation is inverse.

The same investigator also finds that, although most people associate a high and its clear, cold weather with better reception, signals increase as lows pass his receiving station and decrease as highs pass by. This finding, based on quantitative measurements, must be heavily weighted. On short waves, also, we personally have noticed generally better transmission in lows than in highs. A low is of course accompanied by rain and clouds. Out of a total of 27 foreign two-way transmissions from low-power W2CX in a year, 9 were in rain or definitely low pressure areas, 15 were in rain, cloudy or low-pressure areas, and only 8 occurred when the atmosphere was definitely clear. As there were many more attempts than contacts, the contact conditions may be

taken as exceptionally favorable. So far as we are aware, the increased reception as lows pass has not been theoretically explained; we advance the theory that the Heaviside-Kennelly layer sags earthward somewhat in lows, causing a focusing effect as diagrammed in Fig. 2. The air above a low is naturally more rare, so that appreciable ionization can take place lower there than elsewhere. If the layer is well defined, it will hang down in a lens-shaped projection, which could produce the observed effects, either by refraction or by reflection. In general, one quality of temperature and pressure variations must be borne in mind: they are probably related in some way to solar disturbances.

Moisture of course affects transmission. Antenna insulation is poorer in rain; but on the other hand, the ground is a much better reflector when it is wet. At W2CX we have found the best distance reception (and transmission) over wet ground just as the clouds clear away, and this agrees with Pickard's finding that signals increase as a low passes. Even clouds may influence transmission. Clapp found that a cloud drifting into the signal path increased short-wave reception (possibly by a lens focusing effect?). British pilots flying the Channel have noticed that their direction finders were faulty in clouds, possibly due to refractive or reflective effects. Colwell has noticed that broadcast fading is worse on clear days than on cloudy ones. The fading curve seemed to foretell the next day's weather: if the signal curve rose during the evening the next day would be cloudy; if it sank, the morrow would be clear.

Let us emphasize one point which has been frequently overlooked in correlating earthly phenomena with solar activity. As we have seen, the possible earthly effects of solar activity are many and various. The one who considers only weather and the sun, or only radio and the sun, or only radio and the aurora, useful though his findings may be, is perhaps a little like one of those blind men who felt the elephant's trunk and called him a snake, touched his leg and called him a tree, and so on. There are a great many phenomena here, and it is probable that they all react to some extent on one another. That is, after all, one of the most inspiring things about science; the water-tight compartments of its earlier years have been swept away, and the filaments of any one specialized branch extend we know not how far through the great fabric of universal truth.

**A 1930 Broadcast Receiver**

(Continued from page 911)

condenser, which fits along the center of the sub-panel. The very loose antenna coupling obviates the annoying detuning effects common to other single-control receivers, and permits sharply matched circuits over the full 200-550 meter wavelength range.

The detector and audio portions of the circuit are quite orthodox, except for the presence in the audio system of what is best called a "tone equalizer." This

consists merely of a condenser and resistance connected in series and across the primary of the push-pull input transformer. By by-passing some of the higher frequencies the effect is given of accentuating the lower ones, which they pass with difficulty. The resulting "tone quality" is really quite good.

The mechanical arrangement of the parts allows rapid assembly and easy

(Continued on page 969)



Working the Loftin-White

(Continued from page 891)

value for the number of tubes involved.  $\frac{1}{4}$  megohm being used for the three screen-grid tubes of Fig. 2. Likewise, the value of R8 will be larger for a lesser number of tubes. A resistance R9 in the cathode lead develops the bias potential for the tubes, 300 ohms being used for the three tubes of Fig. 2. R9 is also increased in value as the number of tubes is reduced. Usual by-pass condensers C6, each having a capacity of  $\frac{1}{4}$  microfarad, are used in the several positions shown.

Reference to Fig. 2 shows that there is nothing unusual in the details of the three stages of tuned, single-dial control, screen-grid radio-frequency amplification. The shaded base W, grounded at G, indicates the metallic chassis to which the various common ground connections are soldered.

The antenna terminals 1 and 2 provide for long and short antenna connections, the terminal 1 being arranged to bring the antenna condenser Ca in series with the antenna, as the usual provision for a long antenna.

The tuning condensers of the four tunable circuits are indicated as mechanically linked, to provide single-dial control.

The original commercial set included before conversion a -27 power detector resistance coupled to a -27 first audio stage, in turn transformer coupled to a push-pull -45 output stage, and an elaborate filter and power unit. We used the -27 detector socket for our input tube VT1, thus leaving our one -45 output tube to take the place of all that has to do with the resistance-coupled first audio stage and the transformer-coupled two -45 output tubes. We thus have but five tubes where there were seven before, and have eliminated one push-pull transformer and some of the elements of the resistance coupling. The detector, audio, filter and power end are materially reduced in cubical content and cost.

On the other hand, we find that the overall sensitivity of the five-tube system, after conversion, is considerably greater than that of the original seven-tube system. In fact, so much so that we believe that a reduction of the radio-frequency end to two stages would not reduce the sensitivity of the original receiver.

Of course, a suitable connection can be made for connecting a phonograph pick-up in the input circuit of tube VT1 to permit the reproduction of phonograph records, if desired. The manner of connecting this pick-up, PU, for switching in or out of circuit is shown in Fig. 2.

Obviously, the now permissible reduction of the radio-frequency portion of the system to two stages, or even one stage, of radio-frequency amplification will materially lessen the difficulties and cost of construction, and particularly the cost of the task of matching and tracking tuned circuits throughout the broadcast band.

We selected for the conversion described a commercial receiver having a particularly efficient radio-frequency portion, judged from current commercial standards, in order to make certain that our data will be quite adequate to cover all that might be encountered by the experimenter in usual practice.

Have You a Radio in Your Car?

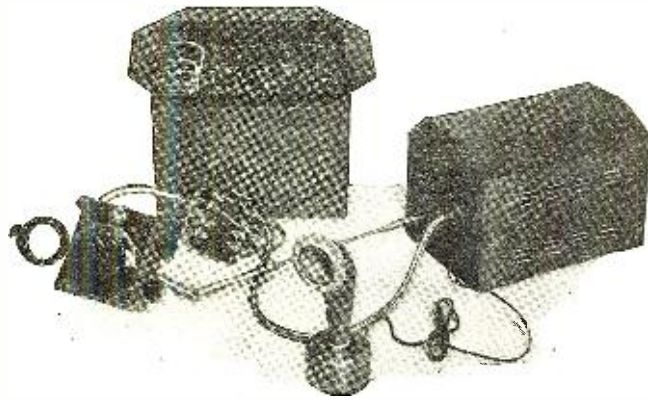

Get all the enjoyment of Radio, right in your car, as you drive, or wait.

National Company has a new series of special Radio parts for Automobile use. The unique design permits instant transfer from car to boat or camp, as conveniently as plugging in a lamp. Easy and rapid to install, does not disfigure the dash, or interfere with leg-room.

Write to-day for full particulars mentioning Radio News.

NATIONAL  
AUTOMOBILE RADIO PRODUCTS

NATIONAL CO., INC., Malden, Mass.

Est. 1914

**NOW 100% EFFECTIVE**

**LAFAYETTE LOFTIN-WHITE AMPLIFIER**

**RADIO'S GREATEST ADVANCEMENT PERFECTED BY OUR LABORATORIES**

The sensational new LOFTIN-WHITE Direct Coupled 245 Amplifier is the most revolutionary development in radio. This amazing system of audio amplification makes use of directly coupled tubes without any intervening condensers or transformers. It assures the use of fewer tubes and parts, of light weight, and compactness. And, of course, an unlimited frequency range without any distortion, and a tremendous output restrained only by the amplification volume of the tubes used. All the necessary A B C requirements for a tuner are incorporated. **WHOLESALE RADIO SERVICE COMPANY**, licensed and approved by Loftin-White Laboratories, has built a Loftin-White Amplifier that carries with it the prestige and guarantee of the Wholesale Radio Service Company.

**MAIL THE COUPON TODAY**

The Lafayette LOFTIN-WHITE Direct Coupled Amplifier is being sold at a sensationally low price. You will find the highest quality built into this De Luxe Model. It carries the nationally-famous Wholesale guarantee — and the low price is only \$25.00. Just mail the coupon below, together with a deposit of \$5.00, and we will ship to you C. O. D. for the balance, plus shipping charges. Or send \$25.00 in full and save time and trouble.

**Money Back If You Are Not Absolutely Satisfied**

**FREE CATALOG**  
The new 1930 **WHOLESALE RADIO CATALOG**—the best of the radio business—will be sent to you **ABSOLUTELY FREE** on request.

**WHOLESALE RADIO SERVICE CO., INC.**  
36 VESEY ST. Dept. F-15 NEW YORK

**WHOLESALE RADIO SERVICE Co., Dept. F-15**  
36 Vesey Street, New York City

Please send Lafayette LOFTIN-WHITE Amplifier ( ) \$5.00 deposit enclosed. Will pay balance of \$20.00 plus shipping charges on delivery.  
( ) \$25.00 enclosed as payment in full.  
If not absolutely satisfied, I will return Amplifier and my money is to be refunded at once.

Name.....  
Address.....  
Town..... State.....  
( ) Send new 1930 WHOLESALE CATALOG also. Enclose F.R.P.

**COUPON**



# Read Classified Advertising—It Pays!!!

Advertisements in this section twenty-six cents a word for each insertion. Name and address must be included at the above rate. Cash should accompany all classified advertisements unless placed by an accredited advertising agency. No advertisements for less than 10 words accepted. Objectionable or misleading advertisements not accepted. Advertisements for these columns should reach us not later than 1st of 2nd month preceding issue.

Classified Advertising Manager—Experimenter Publications, Inc., 381 Fourth Avenue, New York City

### Agents Wanted

**BIG MONEY AND FAST SALES.** Every owner buys Gold Initials for his auto. You charge \$1.50; make \$1.35. Ten orders daily easy. Write for particulars and free sample. American Monogram Co., Dept. 133, East Orange, N. Y.

**Strange Battery Compound** charges instantly. Eliminates old method. Gives new life and pep. Big profits. Gallon free. Lightning Co., St. Paul, Minn.

**Guaranteed Genuine Gold Leaf Letters** anyone can put on store windows. Large profits, enormous demand. Free samples. Metallic Letter Co., 422 N. Clark, Chicago.

### Business Opportunities

**Free Book.** Start little Mail Order business. Hadwilt, 5A-74 Cortlandt Street, N. Y.

**Amateur Cartoonists:** Sell your cartoons, new plan. Smith's Service, EX1194, Wenatchee, Wash.

**Inventions Commercialized.** Patented or unpatented. Write, Adam Fisher Mfg. Co., 278 Enright, St. Louis, Mo.

**Screw-holding screw driver!** Amazing new invention! HOLDS, removes, inserts screws instantly inaccessible places. Factories, garages, electricians, radio owners buy on sight! Sells \$1.50. Exclusive territory. FREE trial order. Jifly, 1541 Winthrop Bldg., Boston.

### Correspondence Courses

**Used correspondence school courses** sold on repurchase basis. Also rented and exchanged. Money-back guarantee. Catalog free. (Courses bought.) Lee Mountain, Pisgah, Alabama.

### Detectives

**Detectives.** Work home or travel. Experience unnecessary. Particulars free. Write George Wagner, 2190 Broadway, N. Y.

### For Inventors

**Inventions Commercialized.** Patented or unpatented. Write, Adam Fisher Mfg. Co., 278 Enright, St. Louis, Mo.

### Help Wanted and Instructions

**WANTED—MEN AND YOUNG MEN** that can solder to make Birceages at home. \$36 a dozen. Particulars free. A. J. Dolis, Dept. AG, 3115 Madison St., Chicago, Ill.

**Wanted Immediately. Eligible Men—Women, 18-55,** qualify at once for permanent Government positions. \$105-\$280 month. Gov't experience unnecessary; paid vacations; Common education; thousands needed yearly. Write, Instruction Bureau, 251, St. Louis, Mo. Quickly.

### Miscellaneous

**Agents, Canvassers, Salesmen, Merchants, etc.,** who are seeking direct contact with manufacturers for live propositions; 100% satisfaction guaranteed; send me 25c (coin or stamps) for one pound of direct contact literature of over 200 unexcelled offers. Ted Armour, 136 East 28th Street, New York, N. Y.

**Inventions Commercialized.** Patented or unpatented. Write, Adam Fisher Mfg. Co., 278 Enright, St. Louis, Mo.

### Patent Attorneys

**Edward Gottlieb, Patent Attorney,** 5 Beekman Street, New York. INVENTIONS patented; confidential advice; inventions developed—representative for Blair Tool and Machine Corp; trademarks registered.

**Patents—Write for Free Instructions.** Send Drawing or Model for Examination. Carl Miller, Registered Patent Attorney (former Patent Office Examiner), 262 McGill Building, Washington, D. C.

**PATENTS—Send for form "Evidence of Conception"** to be signed and witnessed. Form, fee schedule. Information free. Lancaster, Allwine and Rommel, Registered Patent Attorneys in United States and Canada, 269 Ouray Building, Washington, D. C.

**Patents—Advice and booklet free.** Highest references. Best results. Promptness assured. Watson E. Coleman, Patent Lawyer, 724 9th Street, Washington, D. C.

**Inventors—Should write for our Guide Book.** "How to Obtain a Patent," and Record of Invention Blank, sent Free. Send model or sketch of inventions for our inspection and instructions free. Radio, Electrical, Chemical, Mechanical and Trademark Experts. Terms Reasonable. Victor J. Evans & Co., 922 Ninth, Washington, D. C.

### Patents

**Inventions Commercialized.** Patented or unpatented. Write, Adam Fisher Mfg. Co., 278 Enright, St. Louis, Mo.

### Printing, Engraving, Multigraphing

**Multigraphing, two dollars thousand.** Miscellaneous Printing, Mayer Ray Corporation, Monmouth, Illinois.

### Radio

**Indispensable—Set Five Radio Socket Wrenches.** Nov \$1.00. Satisfaction guaranteed. Agents Wanted. "Radio Sockets," 1638 W. Jackson, Chicago.

**Wanted: Men to work with National Radio Service organization.** No selling scheme. Radio Doctors, Inc., Dept. N, Essex St., Salem, Mass.

### Songwriters

**Songwriters—Substantial Advance royalties** are paid on publisher's acceptance. New booklet "Song requirements of Talking Pictures" sent free. Nevecomer Associates, 793 Earl Bldg., New York.

### Telegraphy

**Learn Morse and wireless telegraphy.** Big salaries. Tremendous demand. Expenses low, can earn part. Catalog free. Dodge's Institute, Cour Street, Valparaiso, Indiana.

### Television

**Television. Build your own kit,** send \$1.00 for Book and Blueprint. Morgan Sales Co., 1417 W. Marquette Rd., Chicago.

## Assemble Your Auto-Radio

(Continued from page 965)

volume and switch combined.

The B battery voltages are not very critical. It may surprise some to notice we are placing 135 to 180 volts on the plate of the detector tube. This high voltage is needed because we are employing a power detector which works on the top of the plate characteristic curve.

The chassis is so constructed that the parts will fit in the proper places as specified in the construction directions. To ensure perfection in the operation of the receiver it is necessary to have every wire in its proper place. This method of wiring is described in the diagrams which come with the parts. In order to do away with excessive shielding it was found necessary to make the resistors and condensers as small as possible.

In constructing the set, constant reference should be made to the photographs and diagrams, and care should be taken to follow the instructions in every detail.

## Radio Forum

(Continued from page 948)

The intermediate-frequency amplifier in this receiver is of the usual type, with two broadly tuned transformers and a rather sharply tuned filter. A potentiometer is used for controlling oscillation. The filaments are controlled by a rheostat or by automatic filament ballast. The potentiometer should have a resistance of about 400 ohms. The detector is coupled to the last intermediate-frequency transformer through a grid condenser and a grid leak, C6 and R2, the condenser having a value of about .00025 mfd., while the value of the grid leak depends upon the characteristics of the detector tube. A 2-megohm leak will be suitable for most tubes. The primary and secondary of the filter coupler are shunted by .0005 mfd. condensers. These condensers must be matched closely in order to produce satisfactory results. It may be advisable to use a semi-variable condenser so that these two circuits can be adjusted correctly. The filter coupler is wound on two separate spools, as shown in Fig. 2. Wooden discs about 2 inches in diameter and 3/4 of an inch wide are used for the cores. The sides are fibre discs 4 inches in diameter. The two spools are fastened together with a long brass screw and several nuts as shown. By adjusting the distance between the two coils the tuning can be made sharper or broader, as desired. Both the primary and secondary are wound with No. 32 double cotton-covered wire, each containing 950 turns. The wire should be wound jumble fashion and not in layers.

The broadly tuned intermediate-frequency transformers are constructed with iron cores. A piece of 3/4-inch fibre tubing about 7/8 of an inch long is used to hold the core. Soft iron wire of about 24 gauge is packed into this tube until no more can be forced in. It is advisable to use enameled wire or to insulate the wire with shellac before placing it in the tubes. The spools are made by forcing fibre discs two inches in diameter over the 3/4-inch tube as shown in Fig. 3. The primary is wound with 2,500 turns of No. 36 enameled wire, and the secondary with 2,600 turns of the same wire.

Ever win a prize?  
Here's your chance! Every year we spend over \$150,000.00 on prize offers to advertise our business. In this new offer 150 grand prizes totaling \$6555.00 will be given to the fortunate ones who solve our puzzle correctly and win. Here it is—

**FIND THE "DIFFERENT" AUTO!**

The 16 cars in the circle all look alike. 15 of them are exactly alike—but one is different from all the rest. That's the trick for you! Find this "different" car if you can—and mark it. The difference may be in the fenders, bumper, name plate, radiator, or top. Be careful now—because winner must solve puzzle correctly first in order to

**WIN BUICK SEDAN OR \$2000.00 CASH**

A magnificent list of 150 Grand Prizes—\$6555.00 in all! Lucky first prize winner has choice of new 1930 Buick 4-door Sedan or cash if preferred. Also four other fine new Sedans, radios, victrola, etc., in big prize list. Duplicate prizes awarded in case of ties. All actively interested who have answered correctly will receive prizes or cash rewards.

**\$705.00 FOR PROMPTNESS**

Don't delay—act this minute! Solve the puzzle correctly and receive at once Certificate good for \$705.00 if you are prompt and win first prize, making total first prize worth \$2000.00! This is the only puzzle to solve. Any man, woman, boy, or girl in the U. S. A., outside of Chicago, may submit an answer. 150 of the people who take up this offer are going to win these splendid prizes. Be one of them. Send the number of the "different" auto in a letter or post card today. Nothing to buy, so send no money. But act promptly! **B. A. SLACK,** 500 N. Dearborn St., Room 76 Chicago



## Trail Blazing the Airways by Radio

(Continued from page 909)

and Cleveland, Ohio, respectively—disseminating hourly weather information at the airports and intermediate landing fields along the airway, both day and night. These airways communication stations—to be differentiated from the directive beacon stations which are restricted to the emission of guiding radio signals—ordinarily consist of radio-telephone transmitters, with a power rating of 2,000 watts, and broadcast in voice in the band of frequencies between 315 and 350 kilocycles. These stations, similar in equipment to our popular broadcasting stations, have a dependable communication range of 125 miles. This type of radio aid to navigation is being widely established throughout the United States. Stations are either in operation or in the process of construction at the following points: Hadley Field, New Jersey; Bellefonte, Pennsylvania; Cleveland and Bryan, Ohio; Maywood, Illinois; St. Louis and Kansas City, Missouri; Wichita, Kansas; La Crosse, Wisconsin; Los Angeles, Fresno, Glendale and Oakland, California; Boston, Massachusetts; Spartanburg, South Carolina; Atlanta, Georgia; Portland and Medford, Oregon; and Seattle, Washington.

A device for indicating when a flying course laid out by invisible radio rays has shifted; the development of radio capacity and acoustic altimeters for measuring the heights of aircraft from the ground in absolute feet, and thus offering assistance to pilots landing in fog; the use of a pole antenna instead of a troublesome and sometimes treacherous trailing wire on board flying craft; and the employment of different means and methods for landing craft in fog, are among the other radio aids to navigation now in the process of development. Quite recently the Bureau of Standards, in cooperation with the Guggenheim Fund for the Promotion of Aeronautics conducted experiments with a low-power range transmitter in landing a plane in fog. This radio transmitter outlined the airplane runaway, and through a specially designed altimeter successful blind landings effected. A similar experiment is in progress at College Park, Maryland, in which a short-wave transmitter, operating at a very high frequency, directs a radio beam toward the ground, for guidance of an airplane at a safe gliding angle, when landing blindly or in fog.

(Continued from page 966)

wiring. If you look into the set from the front, you see the triple condenser dividing the sub-panel in the center.

The wiring is exceedingly simple, and will present no difficulties to anyone who can use a soldering iron. As the metal chassis forms the ground and the minus side of the "B" circuit, many connections are made by running the mounting screws right through the soldering lugs or other terminals, and much wiring is saved. Complete assembly and wiring instructions, as well as a full-size working blue-print, are supplied with each kit, and for that reason are not explained in detail here.

# ELECTRICITY OFFERS BIG PAY



**NOW YOU CAN LEARN AT HOME**

**HUNDREDS OF 'COOKE' TRAINED MEN ARE MAKING \$60 to \$100 A WEEK**

**\$12 A Day**

"When I enrolled at small pay, I was a laborer at \$12 a day. Now I am an electrician at \$60 a day in Tulsa, Okla. 809 S. Main St., New York, Okla."

**\$65 A Day**

"But for your course I would still be an small pay instead of making as much as \$65 a day in Astoria, Ore. Jacob Leitch, 1223 1st Ave., Hillsboro, Oregon."



**LEARN BY DOING**



**FREE BOOK COUPON!**

**L. L. COOKE SCHOOL OF ELECTRICITY**  
Dept. 404, 2150 Lawrence Ave., Chicago, Ill.

Send me entirely free and fully prepaid, your book "Secrets of Success in Electricity," with particulars about your Home Study Course in Electricity.

Name: .....

Address: .....

City: ..... State: .....

**The 'Cooke Trained Man' is the 'Big Pay Man'**

Why don't you get into Electricity, too? It's today's great Opportunity for you and every other man who is sick and tired of struggling along on small pay. Hundreds of "Cooke Trained Men" who were no smarter than you when they started now make \$3,000 to \$5,000 a year—and some make even more!

### LEARN AT HOME IN SPARE TIME

Learn with the famous L. L. COOKE "Work Sheet and Job Ticket" Method. It's simple, it's thorough, it's practical. It's just like actual shop experience, yet it's all done right in your own home with the Big Complete Outfit of Tools and Apparatus given to you without extra cost. And it's done in your spare time, without quitting your present job or losing a single hour's pay.

### PREVIOUS EXPERIENCE NOT NEEDED

You don't need previous experience—you don't need higher education to learn Electricity the L. L. COOKE Way. If you can read and write, that's enough. This great Training is amazingly clear and simple. There's nothing like it anywhere. It's the Training with hundreds of successful graduates; it's the Training that has put many men on Easy Street; it's the Training for YOU.

### GET STARTED--MAIL COUPON

"Cooke Trained Men" are the "Big Pay Men" everywhere. \$60 to \$100 a week is what many of them are making. That's the kind of a job for you. Get started under the famous L. L. COOKE Money Back Agreement. Act today to increase your pay. Send coupon for Big FREE Book, "Secrets of Success in Electricity." Mail coupon now.

**L. L. COOKE SCHOOL OF ELECTRICITY**  
Dept. 404, 2150 Lawrence Ave., Chicago, Ill.

### FREE BOOK COUPON!

L. L. Cooke School of Electricity, Chicago, Ill.

Send me entirely free and fully prepaid, your book "Secrets of Success in Electricity," with particulars about your Home Study Course in Electricity.

Name: .....

Address: .....

City: ..... State: .....

# Win \$3,500.00!

To advertise we are going to give over \$7160.00 in prizes. Charles Henflink, between 60 and 70 years old, won \$4245.00 in last offer; Joe Hanslick, 15 years old, won \$900.00; Mrs. D. H. Ziller won \$1800.00. You can win \$3500.00 now.

**CAN YOU FIND THE TWINS?**

Be careful! Don't make a mistake! It's not as easy as it looks because two, and only two, of the seven pictures are exactly alike. Find them—mark them—or send numbers on post card or letter. Over 25 prizes this time, and duplicate prizes in case of ties! Send no money. Anyone who answers correctly may receive prizes or cash. You can have cash or Waco airplane, or automobile, or new home. If correct you will be qualified for this opportunity.

**\$625.00 Extra For Promptness**

—making total prize you can win \$3500.00. Find twin flyers and send answer today. First prize winner gets \$625.00 cash just for promptness. Rush.

**J. D. SNYDER, Publicity Director**  
54 West Illinois St. Dept. 390 Chicago, Illinois



**7160.00 in Prizes**

Subscription Price Going Up!

Save \$1.00 to \$5.00—See page 962



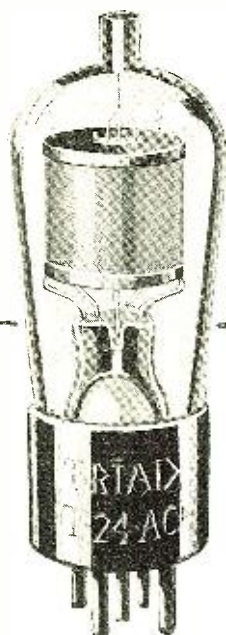

Announcing—  
new

# TRIAD TUBES

Types T-24 and T-27

Triad announces still another achievement—new and highly improved tubes, types T-24 and T-27. New design and



construction now fully protects them against burn-outs and renders them completely non-microphonic. Triad engineers again prove their right to leadership in the radio tube world!

NOW! TRIAD TUBES ARE MANUFACTURED UNDER THE PATENTS OF R. C. A., GENERAL ELECTRIC CO. AND WESTINGHOUSE ELEC. MFG. CO.

TRIAD MFG. CO., Inc.  
Pawtucket, R. I.

# TRIAD RADIO TUBES

## Index to Advertisers

A	Page
Advance Electric Co. ....	955
American College .....	964
American School .....	964
American Technical Society .....	956
Amperite Corp. ....	966
Amplex Instrument Laboratories .....	952
Amplion Corp. ....	970
Amrad Corp. ....	949
B	
Black, R. A. ....	968
Brooklyn Radio Service Corp. ....	965
C	
Cardwell, Allen D. Mfg. Co. ....	965
Central Radio Laboratories .....	955
Chicago Gear Works .....	956
Chicago Radio Apparatus Co. ....	957
Chivily, Nicholas .....	957
Classified Advertising .....	968
Continental Wireless Sales Corp. ....	951
Cooke, L. L., School of Electricity .....	969
Cornish Wire Co. ....	959
Coyne Electrical School .....	881
D	
Davis, Bryan Pub. Co. ....	947
DeForest Radio Co. ....	945
Drake, Frederick J. & Co. ....	966
Drake Hotel, The .....	957
E	
Electrad, Inc. ....	879
Electrad Forum .....	956
Excello Products Corp. ....	960
F	
Flechtheim & Co., A. M. ....	970
G	
Gottlieb, Edward .....	966
H	
Hammarlund-Roberts, Inc. ....	965
High Frequency Labs. ....	960
Hoodwin Co., Chas. ....	961
I	
International Typewriter Exchange .....	966
J	
J. M. P. Mfg. Co., Inc. ....	966
K	
Keeley Inst. ....	957
L	
Lacey & Lacey .....	957
LaSalle Extension University .....	965
Lincoln Radio Corp. ....	953
M	
McGraw-Hill Book Co., Inc. ....	961
Mason, Fenwick & Lawrence .....	960
Metal Cast Products .....	961
M. & H. Sporting Goods Co. ....	970
N	
National Carbon Co., Inc. ....	939-953
National Co., Inc. ....	951-967
National Radio Institute. ....	Back Cover
New Bismarck Hotel .....	961
P	
Piccadilly Hotel .....	956
Pilot Radio & Tube Corp. ....	Inside Back Cover
Piapao Co. ....	961
Projectionist Sound Institute .....	943
R	
Radio Doctors, Inc. ....	953
R. C. A. Institutes, Inc. ....	937
Radio & Television Institute .....	883
Radio Training Association of America .....	877
Radio World .....	958
R. B. Specialty Co. ....	956
Rim Radio Mfg. Co. ....	960
Royal Eastern Electric Supply Co. ....	950
S	
Scott Transformer Co. ....	Inside Front Cover
See Jay Battery Co. ....	952
Shalleross Mfg. Co. ....	963
Silver-Marshall, Inc. ....	941
Snyder, J. D. ....	969
T	
Teleplex Co. ....	956
Thomas, C. M. ....	956
Townsend Labs. ....	956
Triad Mfg. Co., Inc. ....	970
20th Century Mail Order Corp. ....	950
V	
Van Nostrand Co., D. ....	957
W	
Wellston Radio Corp. ....	959
Weston Electrical Instrument Corp. ....	954
West Side Y. M. C. A. Radio Inst. ....	964
Wholesale Radio Service Co. ....	967
Wiley, John & Sons .....	963
Y	
Yahr-Lange, Inc. ....	961
Yaxley Mfg. Co. ....	965

(While every precaution is taken to insure accuracy, we cannot guarantee against the possibility of an occasional change or omission in the preparation of this index.)

## Two Remarkable Condensers —by FLECHTHEIM

Achievements That Are Rapidly Gaining New Users

### TYPE HV

Rated at 500 volts rms RAC — 800 D. C. (For 245-345 tubes.)

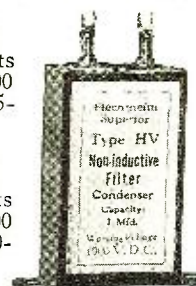

### TYPE HS

Rated at 660 volts rms RAC—1000 D. C. (For 250-350 tubes.)

Both types have these fine characteristics:

- Non-Inductively wound
- Resistance over 600 meg. per mfd.
- Remarkable Small Size
- Negligible Power Factor and Di-electric Losses.

BETTER IN EVERY WAY

Used in Loftin-White Voltage Coupled Amplifier

Also a Complete Line of

**FLECHTHEIM** FOR EVERY SUPERIOR CONDENSERS PURPOSE

Send for Catalogue No. 20

A. M. FLECHTHEIM & CO., Inc.  
136 Liberty St., New York City.

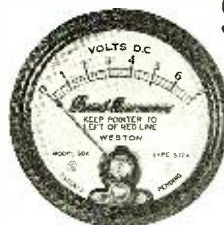

\$7 Weston VOLT METER

Special \$1.79

7-volt, D. C. Exceptional price. Order early. Complete Parts Loftin-White Power Packs. \$35.00 List

R. C. A. Sockets for Transmitting, \$1.

M.&H.SPORTINGGOODSCO.

512 Market St. Phila., Pa.

## Complete PUBLIC ADDRESS EQUIPMENT

of Unsurpassed Dependability

MICROPHONES—SPEAKERS  
AMPLIFIERS—PICK-UPS  
TURNTABLES

FADERS and ACCESSORIES  
Everything for PUBLIC ADDRESS  
Write for Catalog



Corporation of America  
135 West 21st St.  
New York

COMPLETE APPARATUS FOR Hotels Schools Churches Clubs Auditoriums Immediate Delivery



# IMPORTANT

to

*Service-Men . . . . Radio Engineers  
Radio Technicians . . . Repair Men  
Custom Set-Builders*

WE are constantly being asked for names of competent radio technicians and service-men. A real shortage of such men exists, as servicing is still a great problem for most manufacturers.

We are, therefore, compiling a complete list of all the men the radio manufacturer can call upon whenever he needs help—help that you can give and be well paid for.

All you have to do is fill out the blank below, and return it to us so we can add your name and radio history to this list of experts. There is no charge made for this service, either to you or the radio manufacturer.

We merely want to give you an additional opportunity to make more money and gain more prominence in your chosen profession.

**Just Fill Out and Mail to Service-man's Dept., Radio News, 381 Fourth Avenue, New York City**

Name ..... Age.....

Address ..... City ..... State .....

Education: (Public School).....(High School).....(College).....  
(Technical School).....(Correspondence Course).....

Do you have your own business?..... Address.....  
or by whom employed?..... Address .....

How long have you been in the Radio Business?.....

What technical magazines do you read?.....

What type of radio business do you conduct? (please check)  
Repair.....Installation.....Sales.....Custom-built Sets.....

Do you make "public address" installations?.....What make?.....

Do you recommend any particular make of custom built kit set to your clients?.....  
What make?.....

Are you the accredited agent of any manufacturer for servicing and repair?.....  
If so, whom?.....

What test equipment do you possess?.....

Does your radio business require all your time or are you employed elsewhere in some other profession?.....  
If so, what?.....

Remarks: .....



The Most Fascinating Radio Book of the Year!

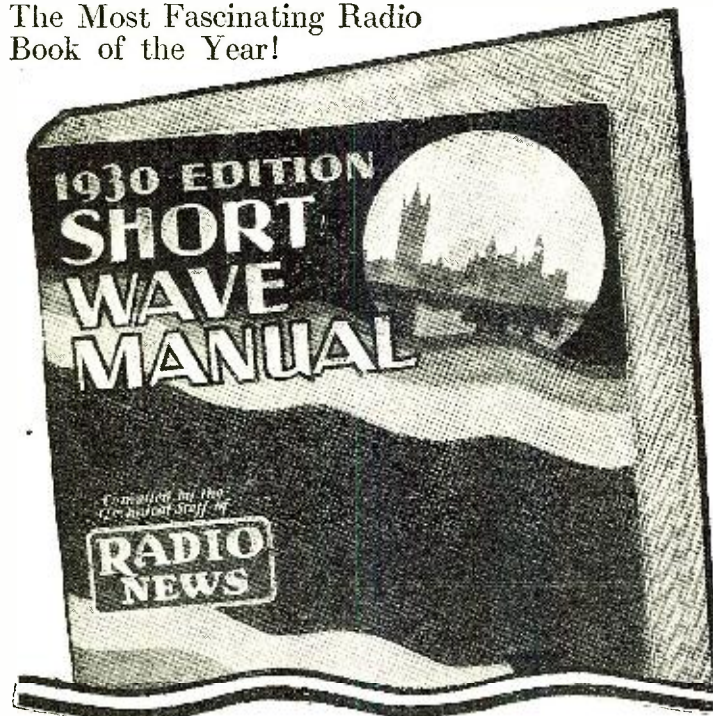

The Latest Most Authoritative Information Available on

# SHORT WAVES

Complete Volume Only **50¢** While They Last

**T**HE thrill of the Short Waves! It's like the invention of radio all over again. If you've ever decoded messages straight from South Africa or Australia—if you've ever known the kick of getting Europe or Little America direct—if you've ever had SW chats with friends hundreds of miles away, then you know what we mean.

The Short Waves are opening up a tremendous new field of amazing possibilities. An entirely new world of experimenting, of thrills, of new experiences with these miraculous SWs lies ahead.

Because you and thousands of other radio men want to keep posted on all the latest wrinkles on Short Waves, the Technical Staff of RADIO NEWS has especially prepared a complete new, up-to-the-minute SHORT WAVE MANUAL.

Its twenty-three chapters, replete with illustrations, diagrams, charts and plans, bring you the results of years of research work by the foremost authorities in the field—the last word in authentic SHORT-WAVE data. Many of the chapters were especially written by that famous

SW expert, Lieut. W. H. Wenstrom. You will be fascinated with such features as:

- Breaking Into Amateur Transmitting
- S-W Transmitter for the Average Home and Purse
- A Portable S-W Transmitter and Multi-wave Receiver
- For Real Thrills Get Down in the Amateur Wave Bands
- Ready for a Short-Wave Chat
- Getting the Most From Your S-W Transmitter
- Some Experiments on Ultra-High Frequencies
- Short-Wave Stations of the World

It is one thing to pound the key of a short-wave transmitter and hope to high heaven that your signals are "getting out." It is another thing to understand intelligently the conditions under which perfect results are secured and how to get the most out of Short Waves.

Here is the book that explains everything—that describes and illustrates all the new inventions and improvements—that gives you the complete and latest SW data. In short, here's just the book you want—at a price so low that anybody can afford it!

**FREE**  
You may secure the SHORT WAVE MANUAL without cost with a subscription to RADIO NEWS. See coupon below.

**----- Mail Coupon TODAY! -----**

RADIO NEWS, Dept. 2404-G  
MACKINNON-FLY PUBLICATIONS, Inc.  
381 Fourth Avenue, New York, N. Y.

Gentlemen: I enclose 50c (in stamps, coin or money order) in full payment for the new 1930 SHORT WAVE MANUAL, which it is understood will be shipped to me by return mail.

-OR-

Ship me ENTIRELY FREE the new 1930 SHORT WAVE MANUAL and enter my subscription for the next eleven big issues of RADIO NEWS at the special price of only \$2.00, which I enclose (regular newsstand price \$2.75).

Name .....

Address .....

City and State .....

Are you a Serviceman ? Engineer ? Dealer ? Experimenter ?

Present subscriptions will be extended from expiration.

**Buy It from Your Ne sdealer or Mail Coupon NOW!**



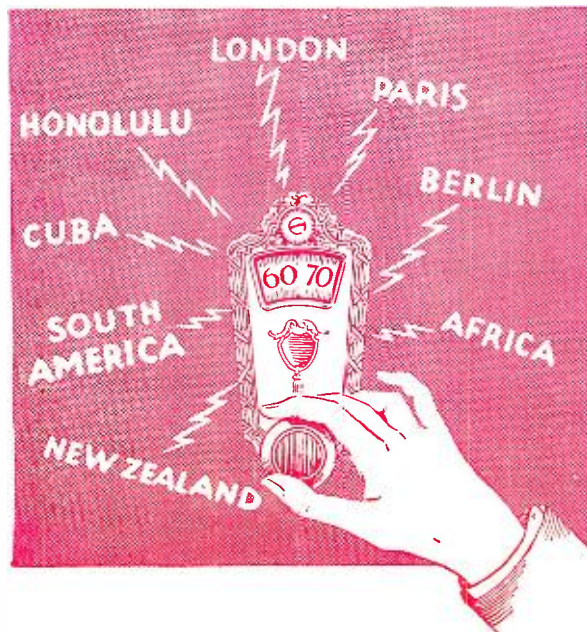

# Hear-

## Foreign Radio Stations DIRECT

See Nearest Dealer or  
Write Direct for Details

Kit K-115: The A.C. Super  
Wasp. Use your own ABC  
pack or Pilot K-111 at  
\$16.50, specially designed  
for the Super-Wasp. Power  
Pack and Tubes Extra . . . .

**\$34<sup>50</sup>**

Kit K-110: The battery-  
operated Super-Wasp.  
Batteries and Tubes extra . . .

**\$29<sup>50</sup>**

**Without Dependence On  
Local Re-Broadcasting!**

### PILOT SUPER-WASP

Short Wave and Broadcast Receiver  
RANGE 14 TO 500 METERS

In Kit Form for A. C. or Battery Operation

**Widen Your Circle of Entertainment!**

Your broadcast receiver is useless below 200 meters, but the Super-Wasp, swooping down to 14 meters, and up to 500, unlocks a new world of trans-oceanic radio you never heard before! And you get it directly from the foreign station and not from a local rebroadcast. Enthusiasts report European, African, South American and Australian stations. Music amazingly new! Welcome variety for listeners "fed up" with domestic radio programs! To assure consistently satisfactory operation, Pilot engineers developed the Pilotron P-227, which naturally makes it a splendid tube for broadcast receivers.



### PILOT RADIO & TUBE CORP.

323 BERRY STREET  
BROOKLYN  
N. Y.



Chicago Office: 234 South  
Wells Street  
San Francisco Office: 1278 Mission  
Street

## JOINING THE RADIO INTERNATIONAL GUILD

Costs only 50c and includes lapel pin, certificate and "Radio Design" Construction Quarterly Magazine, the Guild's Official Organ. Enclose 50c coin or stamps to Radio International Guild, 103 Broadway, Brooklyn, N. Y.

Name .....

Address .....

City ..... State .....

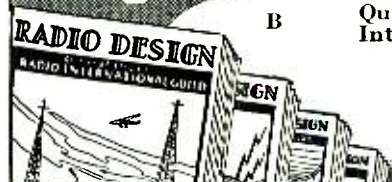





# MEN!

Get Your Copy of **My New Book**

*It shows you*

## How to get a good job in the Radio Industry

**Hundreds of Jobs paying \$50, \$60, \$75, \$100 a week are opening in Radio every year.**

**J.E. SMITH, Pres**  
NATIONAL RADIO INSTITUTE

I showed these men how to get **Big Pay** jobs like these



### Seldom Under \$100 a Week

"My earnings in Radio are many times bigger than I ever expected they would be when I enrolled. In November I made \$577, December \$645, January \$465. My earnings seldom fall under \$100 a week. I merely mention this to give you some idea of what a Radio man can do who has the training."

E. E. WINBORNE,  
1414 W. 48th St., Norfolk, Va.



### \$3000 a Year in Own Business

"I cannot give N. R. I. too much credit for what I have been able to do in Radio. I can safely say that I averaged \$3000 a year for the past three years. I am in the Radio business here. Any man who really wants to advance cannot go wrong in Radio. There is certainly a lack of trained men."

FRED A. NICHOLS,  
P. O. Box 207, Eaton, Colo.

If you are earning a penny less than \$50 a week, send for my book of information on opportunities in Radio. It is free. Radio's amazing growth is making hundreds of fine jobs every year. My book shows you where these jobs are, what they pay, how I can train you at home in your spare time to be a Radio Expert.

### You have many Jobs to choose from

Broadcasting stations use engineers, operators, station managers and pay \$1,800 to \$5,000 a year. Manufacturers continually need testers, inspectors, foremen, engineers, service men, buyers for jobs paying up to \$15,000 a year. Shipping companies use hundreds of operators, give them world-wide travel with practically no expense and \$85 to \$200 a month besides. Dealers and jobbers (there are over 35,000) are always on the lookout for good service men, salesmen, buyers, managers and pay \$30 to \$100 a week for good men. Talking Movies pay as much as \$75 to \$200 a week to men with Radio training. There are openings almost everywhere to have a spare time or full time Radio business of your own—to be your own boss. Radio offers many other opportunities. My book tells you about them. Be sure to get it at once.

### My New 8 Outfits of Parts give you extensive Practical Radio Experience

With me you not only get the theory of Radio—you also get practical Radio experience while learning. You can build over 100 circuits—build and experiment with the circuits used in Atwater-Kent, Majestic, Crosley, Eveready, Stewart-Warner, Philco, and many other sets. These experiments include A. C. and screen grid sets, push pull amplification and other late features. When you finish my course you won't need to take "any old job" just to get experience—you will be trained and experienced ready to take your place alongside men who have been in the field for years.

Back view of 5-tube A. C. screen grid tuned Radio frequency set—only one of many circuits you can build with the parts I give without extra charge.



### I Will Train You at Home in Your Spare Time

Hold your job until you are ready for another. No need to leave home. All I ask is part of your spare time. I have doubled and tripled the salaries of hundreds through my practical home-study training. You don't have to be a high school or college graduate. My course is written in easy, simple terms that most anyone can understand.

### My course includes Talking Movies, Wired Radio, Television

My course is up-to-date with Radio's latest uses and improvements. It includes Radio's latest application to Talking Movies, Television and home Television experiments, Wired Radio, Radio's use in Aviation, in addition to fitting you for many other lines. When you finish you won't be a "one job" man. You will be trained for many jobs.

### Money Back If Not Satisfied

I will agree in writing to refund every penny of your tuition if you are not satisfied with my Lesson Texts and Instruction Service when you have finished my course. This agreement is backed by the Pioneer and World's Largest organization devoted entirely to training men and young men for good jobs in the Radio industry, by correspondence.

### Find out what Radio offers you Get My Book

This book gives you the facts on Radio's opportunities and the many features and services of N.R.I. training. It gives you 100 letters from actual students who have proved that my methods are successful. Get your copy today. There is no obligation.

**J. E. SMITH, President,**  
National Radio Institute, Dept. ODS  
Washington, D. C.

**THIS COUPON IS GOOD FOR ONE FREE COPY OF MY NEW BOOK**

**mail it NOW**

J. E. SMITH, President  
National Radio Institute, Dept. ODS  
Washington, D. C.

DEAR MR. SMITH:—Send me your book. I want to see what Radio offers and what you offer in Radio training. This request does not obligate me in any way.

Name.....

Address.....

City.....State.....

**Lifetime Employment Service to all Graduates**